

# BANDO

## V-BELT AND TIMING BELT INSTALLATION AND MAINTENANCE

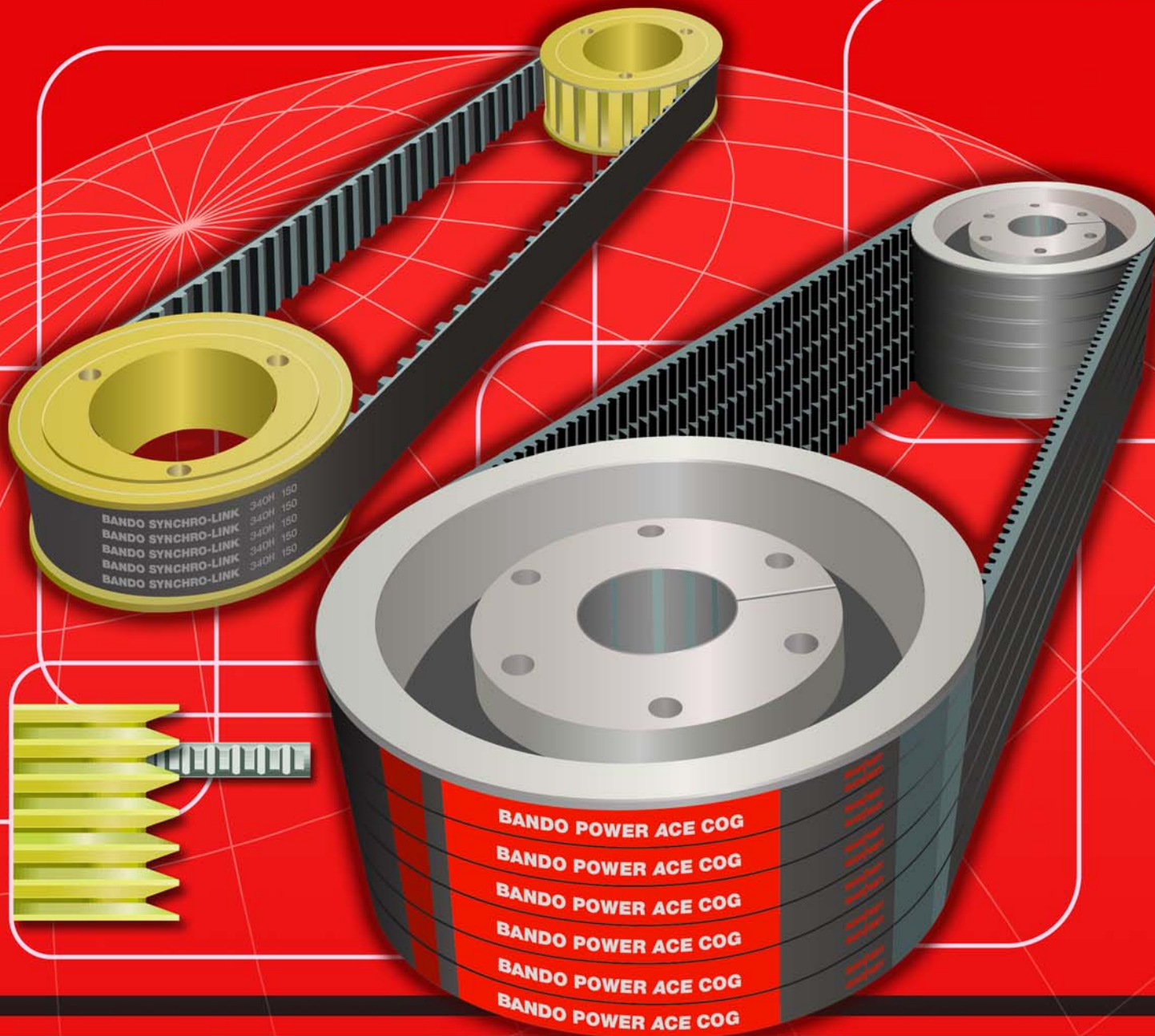

## Introduction

The purpose of this manual is simple: to help you get maximum value from your belt drives. As you review this information, you'll understand why belts are industry's most widely used means of power transmission. They are easy to select, simple to install, and will give you years of efficient, trouble-free service.

Properly designed and installed belts are virtually maintenance-free; an occasional retensioning is all that's needed to keep them running smoothly. Because belt drives require so little attention, it's worth your time to follow the "common sense" guidelines in this manual. The payoff is maximum belt and sheave life, increased uptime, and efficient, uninterrupted equipment service.

### 10 Point V-Belt Installation Check List

- 1. Turn equipment OFF and lock out power source.
- 2. Shorten center distance and remove old belts.
- 3. Inspect and service take-up rails, bearings, and shafts.
- 4. Inspect and clean sheaves; replace worn and damaged sheaves.
- 5. Check and correct sheave alignment.
- 6. Select replacement belts.
- 7. Lay belts over sheaves; rotate until belts' slack is on the same side.
- 8. Check final sheave alignment.
- 9. Increase center distance until belts won't slip under a full load.
- 10. Inspect belt drive in 24-48 hours.

## Index

	Page
V-Belt Installation	
Remove Old Belts . . . . .	1
Inspect and Service Drive Elements . . . . .	1
Inspect/Replace Sheaves . . . . .	1
QD® Sheave Installation and Removal . . . . .	1
Check Sheave Alignment . . . . .	2
Select Replacement Belts . . . . .	2
Install New Belts . . . . .	2
Check Final Sheave Alignment . . . . .	2
Tension Belts . . . . .	2
Inspect Drive in 24-48 Hours . . . . .	3
Belt Storage Tips . . . . .	3
Synchro-Link® Timing Belt Drives . . . . .	3
Installation . . . . .	3
Tensioning . . . . .	4
Taper-Lock® Pulley Installation and Removal . . . . .	4
Rib Ace® Drives . . . . .	4
Quarter Turn Drives . . . . .	5
V-Flat Drives . . . . .	5
Idlers	
V-Belt . . . . .	5
Timing Belt . . . . .	5
Troubleshooting Guide . . . . .	6 & 7
Troubleshooting Examples . . . . .	8
Bando Product Line . . . . .	Inside Back Cover

Bando is proud to support and actively participate in these premier industry associations.



## V-Belt Installation

**Caution:** Before doing any inspection or maintenance on belt drives, turn the equipment off and lock out the power source.

### Remove old belts

Remove the drive guard, loosen the take-up, and shorten the center distance between sheaves. This way, the old belts can be removed easily and the new belts can be installed without damage.

### Inspect and service drive elements

Remove rust and dirt from take-up rails, and lubricate as necessary. Inspect and replace damaged machine elements such as worn bearings and bent shafts. Check bearings for oil.

### Inspect and clean sheaves; replace worn or damaged sheaves

Worn sheave grooves are one of the principal causes of premature belt failure. Get your money's worth from a new set of belts by inspecting the sheaves carefully!

- Clean dirty, dusty, or rusty sheaves. They will impair the drive's efficiency and wear out the belt cover.
  - Feel sheave grooves (wear gloves or use a rag) for nicks or burrs, and file them smooth.
- Belts should ride in sheave grooves so that the top of the belt is just above the highest point of the sheave. If the grooves are worn to the point where the belt bottoms out (a clue: check for shiny groove bottoms), the belts will slip and burn.
- If the groove walls are "dished out," the bottom corners of the belt will quickly wear off and cause rapid failure. Check groove wear by sight, touch, or with a Bando sheave gauge. If grooves are "dished out" 1/32" or more — replace the sheaves!

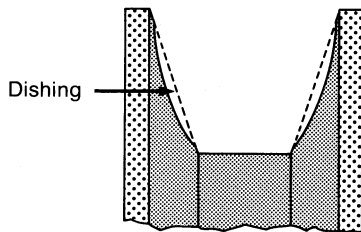

"Dishing" of groove sidewalls shortens belt life

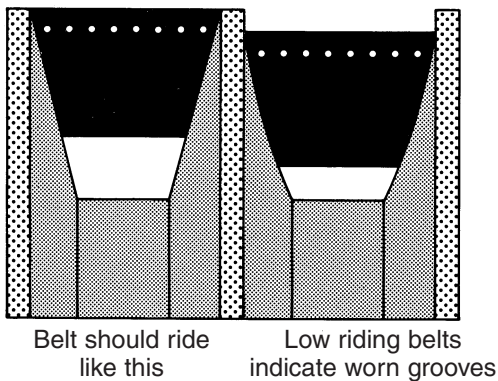

Belt should ride like this

Low riding belts indicate worn grooves

## Sheave installation and removal

### To install QD® sheaves:

The conventional mounting position for QD® sheaves is with the bushing flange located toward the bearing. The reverse mounting position (for QD® bushing sizes JA through J) is with the flange of the bushing toward the open end of the shaft. For either position:

1. Make sure the sheave bore and the tapered cone surface of the bushing are clean and free from paint, dirt, and lubricants. *Do not use lubricants to install QD® bushing assemblies.* Loosely assemble the bushing in the sheave, and insert the cap screws finger tight.
2. Slip the loosely assembled unit onto the shaft and position it for proper belt alignment.
3. Tighten down the hollow head setscrews in the flange on the key, snug enough to keep it in the desired position on the shaft.
4. Tighten the cap screws alternately and progressively to about half the recommended torque values in the table below. Check alignment and sheave runout (wobble) and correct as necessary. Continue to tighten the cap screws alternately and progressively to the torque values below. To increase leverage, use a wrench or length of pipe.
5. Tighten the setscrew on the key to hold it securely in place during operation.

**NOTE:** Don't allow the sheave to be drawn in contact with the bushing flange. There should be a 1/8" to 1/4" gap when properly mounted.

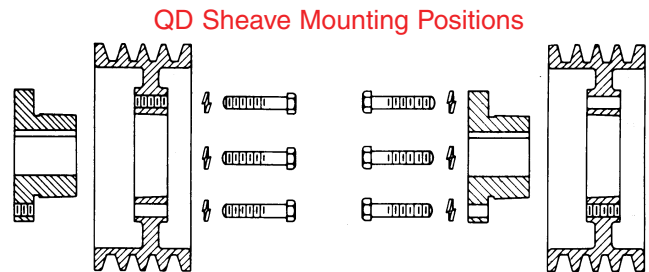

### Torque Values for Tightening QD Bushings

QD Bushing	Wrench Torque (In. Lbs.)	QD Bushing	Wrench Torque (In. Lbs.)
JA	.72	E	.720
SH	.108	F	.900
SDS	.108	J	.1620
SD	.108	M	.2700
SK	.180	N	.3600
SF	.360	P	.5400

### To remove:

1. Loosen and remove all mounting cap screws. Insert two or three of the cap screws in the tapped removal holes in the sheave. Start with the screw opposite the bushing saw slot and progressively and alternately tighten each screw until the cone grip is broken between the sheave and the bushing.
2. Remove the sheave and bushing from the shaft. If the bushing won't slip off the shaft, wedge a screwdriver blade in the saw slot to loosen.

QD® is a registered trademark of Emerson Electric. Taper-Lock® and TL are registered trademarks of Reliance Electric.

## Check and correct sheave alignment

Misaligned sheaves will accelerate wear of belt sidewalls, which will shorten both belt and sheave life. Misalignment can also cause belts to roll over in the sheave, or throw all the load to one side of the belt – breaking or stretching the tensile cord.

Check for the types of sheave and shaft misalignment shown below. Correct alignment by placing a steel straightedge across the sheave faces so it touches all four points of contact.

### Types of sheave and shaft misalignment

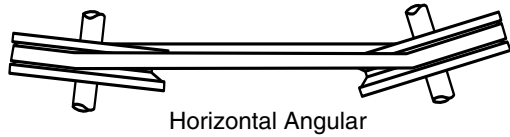

Horizontal Angular

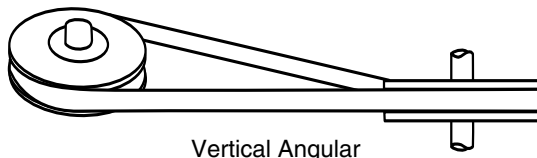

Vertical Angular

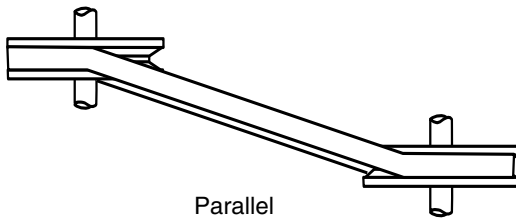

Parallel

Align with straightedge along sheave faces

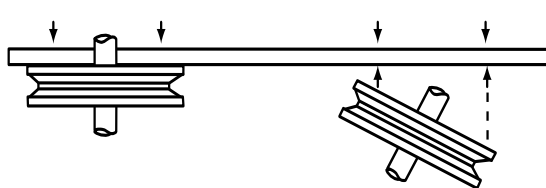

## Select replacement belts

### • Don't mix used and new belts on a drive

Used belts will ride lower in the sheave groove due to sidewall wear and normal stretch. New belts will ride higher in the sheave, travel faster, and operate at higher tension. Running used and new belts together will overload and damage the new belts.

Used belts may be used elsewhere on a light duty drive, or for emergencies.

### • Don't mix belts from different manufacturers

Because dimensions and constructions vary among manufacturers, running such "mismatched belts" won't give full service life.

If the belt length is not known, the following formula can be used to calculate belt length:

$$\text{Length} = 2CD + 1.57(D+d) + \frac{(D-d)^2}{(4CD)}$$

where CD=Center Distance, D=Large Sheave Diameter, and d=Small Sheave Diameter.

### • Use matched sets

A matched set of belts is necessary to assure equal distribution of the load. With some manufacturers, length codes are necessary to match belts within a given size. Observe proper guidelines if your belts have match numbers.

Bando's **BAN/SET**® process eliminates the need for match numbers — all belts of a given size will match with all others of that size. This system simplifies ordering, reduces inventory, and assures you'll have a matched sets of belts on hand.

### • Use correct type and cross section belt

Match the correct belt cross section to the corresponding sheave groove — A to A, 3V to 3V, etc. Don't use a B section belt in a 5V sheave, or vice versa.

Don't replace A or B section belts with 4L or 5L fractional horsepower (FHP) belts. The dimensions are similar, but FHP belts can't handle the horsepower requirements of a heavy duty application.

Use Bando Combo belts when vibration and shock loads cause belts to turn over or jump out of the sheave grooves.

### Install new belts and adjust the slack

Always shorten the center distance of the drive until the belts can be laid over the sheaves. *Never* pry or force a belt on the drive with a pry bar or by cranking. This will almost certainly damage the tensile cord and although the injury may not be visible, belt life will be drastically reduced.

Work the belts by hand to move slack so it is on the same side — top or bottom — for all belts. This assures all belts start under equal strain. Now, move the sheaves apart until the belts are seated in the grooves and the slack is taken up.

### Check final sheave alignment

Once again, check sheave alignment with a straight-edge and observe:

- parallel position of the sheave shafts
- correct alignment of the sheave grooves

*Note: Mount sheaves as close to the bearings as practical to avoid excessive loads on the bearings and shafts.*

### Tension belts

The key to long, efficient, trouble-free belt operation is proper tension. If belts are too loose, the result is slippage, rapid belt and sheave wear, and loss of productivity. Conversely, too much tension puts excess strain on belts, bearings, and shafts, and causes premature wear of these components. Follow this tensioning guideline: the proper tension for a V-belt is the *lowest* tension at which the belt won't slip or squeal under peak load.

*Note: Never use belt dressing to stop belts from slipping. Tighten the belts and/or check for worn sheave grooves.*

To tension belts, adjust the center distance until the belts appear fairly taut. Run the drive for about 15 minutes to seat the belts, and apply full load. If the belts slip or squeal, apply more tension. When the drive is in motion, a slight sag on the slack side is normal.

An alternate method of tensioning is to use the simplified force/deflection method, as follows:

## Force/deflection method

1. Measure the span length "L" of your drive (see Figure 1).
2. At the center of the span, apply a force perpendicular to the belt. Measure the force required to deflect the belt 1/64" per inch of span length. For example, for a 100" span, the deflection would be 100/64", or approximately 1 1/2 inches.
3. Compare the force required to the recommended ranges in the tables below. Tighten or loosen the belt to bring it into the recommended range.
4. When you install new belts, tighten them to "initial tension" forces shown in the tables. This tension will drop during the run-in period.

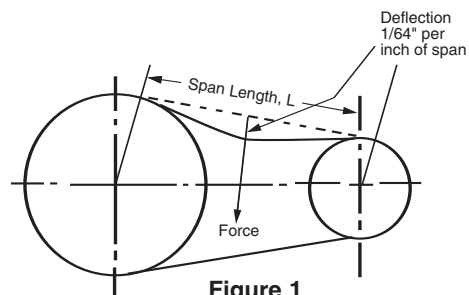

Figure 1

## V-Belt Tensioning

V-Belt Cross Section	Small Sheave Diameter Range (Inches)	Recommended Deflection Force (Lbs.)		
		Initial Installation	Retensioning	
			Maximum	Minimum
A	- 3.0	3.6	3.1	2.4
	3.1 - 4.0	4.2	3.6	2.8
	4.1 - 5.0	5.2	4.6	3.5
	5.1 -	6.1	5.3	4.1
B	- 4.6	7.3	6.4	4.9
	4.7 - 5.6	8.7	7.5	5.8
	5.7 - 7.0	9.3	8.1	6.2
	7.1 -	10.0	8.8	6.8
C	- 7.0	12.5	10.7	8.2
	7.1 - 9.0	15.0	13.0	10.0
	9.1 - 12.0	18.0	16.3	12.5
	12.1 -	19.5	16.9	13.0
D	12.0 - 13.0	25.5*	22.1	17.0
	13.1 - 15.5	30.0*	26.0*	20.0
	15.6 - 22.0	32.0*	28.0*	21.5
E	18.0 - 22.0	45.0*	39.0*	30.0*
	22.1 -	52.5*	45.5*	35.0*
3L	1.5 - 2.0	1.4	1.1	0.8
	2.1 - 2.7	1.9	1.4	1.1
	2.8 - 4.0	2.5	2.0	1.5
4L	2.0 - 2.5	2.1	1.6	1.2
	2.6 - 3.5	2.4	1.8	1.4
	3.6 - 5.0	3.1	2.3	1.8
5L	3.0 - 3.5	3.2	2.5	1.9
	3.6 - 4.5	4.1	3.2	2.4
	4.6 - 6.0	5.1	3.9	3.0
AX	- 3.0	5.1	4.4	3.4
	3.1 - 4.0	5.5	4.8	3.7
	4.1 - 5.0	6.0	5.2	4.0
BX	- 4.6	10.0	8.7	6.7
	4.7 - 5.6	11.0	9.5	7.3
	5.7 - 7.0	11.5	9.9	7.6
CX	- 7.0	18.0	15.6	12.0
	7.1 - 9.0	19.5	16.9	13.0
	9.1 - 12.0	20.0	17.6	13.5
3V	12.1 -	21.0	18.2	14.0
	2.65 - 3.35	4.6	4.0	3.1
	3.65 - 4.50	5.5	4.8	3.7
5V	4.75 - 6.0	6.4	5.6	4.3
	6.5 - 10.6	7.3	6.4	4.9
	7.1 - 10.3	16.5	14.3	11.0
8V	10.9 - 11.8	19.5	16.9	13.0
	12.5 - 16.0	21.0	18.2	14.0
	12.5 - 16.0	39.0*	33.8*	26.0*
3VX	17.0 - 20.0	45.0*	39.0*	30.0*
	21.2 - 24.4	51.0*	44.2*	34.0*
	2.2 - 2.5	4.8	4.2	3.2
5VX	2.65 - 4.75	5.7	4.9	3.8
	5.0 - 6.5	7.2	6.2	4.8
	6.9 -	8.7	7.5	5.8
5VX	- 5.5	15.0	13.0	10.0
	5.9 - 8.0	19.0	16.9	13.0
	8.5 - 10.9	21.0	18.2	14.0
5VX	11.8 -	22.0	19.5	15.0

Note: For banded belts, multiply the force in the table by the number of belts in the band.

\* 1/2 of this deflection force can be used, but substitute deflection amount as follows:

$$DA \text{ (inches)} = \frac{LS \text{ (inches)}}{128}$$

## Inspect belt drive in 24-48 hours

During the 24-48 run-in period, the initial stretch is taken out of the belts and the belts seat lower in the sheaves. Check belt tension to assure it falls between the maximum and minimum values shown in the tables to the left.

## Belt Storage Tips

Under proper conditions, belts can be stored for many years without shortening service life. Follow these guidelines:

- Store belts in a cool, dry, dust-free area, away from radiators and direct sunlight. Temperatures below 85° and relative humidity below 70% are recommended.
- Store belts away from ozone producing unguarded fluorescent lights, mercury vapor lights, and high voltage electrical equipment.
- Don't store belts near chemicals, oils, solvents, lubricants, or acids.
- Belts can be coiled on shelves or hung on pegs. Avoid sharp bends and stresses that can cause permanent deformation and cracks. Stack belts no higher than 12" to prevent damage to bottom belts. When hanging, coil longer belts to prevent distortion from belt weight.

## Synchro-Link® Timing Belt Drives

### Installation

Inspect timing belt pulleys for dirt, rust, damage, and wear. Clean pulleys as needed; replace worn or damaged pulleys.

Check that the pulley support structure is rigid. Loose supports cause center distance variation, shaft misalignment, and pulley-tooth disengagement.

Check drive alignment with a straightedge and make sure pulleys and shafts are parallel. On a long-center drive, it's often advisable to slightly offset the driveN pulley to compensate for the belt's tendency to run against one flange of the driveR pulley.

Never force or pry a belt over the pulley flange. Reduce center distance or idler tension, or remove one or both pulleys. Lay the belt over the pulleys and adjust the take-up until the belt teeth mesh securely with the pulley grooves.

## Tensioning

Timing belts should fit the pulleys snugly — neither too tight nor too loose. The “tooth grip” principle eliminates the need for high initial tension. A snug belt-pulley fit extends belt and bearing life, and gives quieter operation.

Measure span length (“L” in Figure 2 below) and apply a force perpendicular to the belt. Measure the force required to deflect the belt 1/64" per inch of span length. Compare the force required with the table below and tighten or loosen the belt as required, to bring it into the recommended range.

For example, an H pitch belt, 1" wide with a span of 30", should take a force of 5.2-6.8 lbs. to deflect the belt 30/64", or about 1/2".

### Timing Belt Tensioning

Belt Size	012	019	025	031	037	050	075	100	150	200	300	400	500	600
Belt Width	1/8"	3/16"	1/4"	5/16"	3/8"	1/2"	3/4"	1"	1 1/2"	2"	3"	4"	5"	6"
MXL	Max.	.10	.15	.24	.35	.42	.62							
	Min.	.05	.09	.13	.19	.22	.33							
XL	Max.			.42	.55	.66	1.1	1.9						
	Min.			.20	.31	.37	.57	1.0						
L	Max.					1.3	2.1	2.9	4.7	6.4				
	Min.					1.0	1.5	2.2	3.4	4.7				
H	Max.						4.7	6.8	10.4	14.3	22.4			
	Min.						3.7	5.2	8.2	11.2	17.6			
XH	Max.								17.7	27.9	39.7	51.0	62.2	
	Min.								16.3	25.8	36.7	47.0	57.3	
XXH	Max.									40.5	63.9	90.7	117.2	142.1
	Min.									21.5	34.0	48.1	62.3	75.2

Units are lbs.

For tensioning values on HT, XP or STS drives consult Bando with drive parameters or request Bando Publication BU-200.

## Taper-Lock® Pulleys

To install:

1. Place bushing in the pulley.
2. Apply oil to both the thread and the point of setscrews. Place screws loosely in pull-up holes.
3. Make sure the bushing is free in the pulley. Slip the assembly onto the shaft and position it for proper belt alignment.
4. Tighten the screws alternately and progressively until they are tight. To increase leverage, use a wrench or length of pipe.
5. Tap the large end of the bushing (use hammer and block or sleeve to prevent damage). Tighten the screws to the torque values shown in the following table. Fill the other holes with grease to keep dirt out.

## Torque Values for Tightening TL® Bushings

TL® Bushing	Wrench Torque (In. Lbs.)
TL1008	.55
TL1210	.175
TL1215	.175
TL1610	.175
TL1615	.175
TL2012	.280
TL2517	.430
TL3020	.800
TL3535	1.000
TL4040	1.700

To remove:

1. Remove both setscrews.
2. Apply oil to both the thread and point of one setscrew. Insert this screw in the tapped removal hole, and tighten the inserted screw until the bushing is loose in the sheave. (Note that one setscrew is not used for removal.)

## Rib Ace® Drives

### Installation

Clean rust and dirt from Rib Ace® sheaves; replace worn or damaged sheaves. Sheave alignment is very important, and should be checked with a straightedge as shown on page 2.

Never force or pry a Rib Ace® belt over the sheaves. Reduce the center distance and lay the belts over the sheaves.

### Tensioning

Measure span length (“L” in illustration below) and apply a force perpendicular to the belt. Measure the force required to deflect the belt 1/64" per inch of span. Multiply the number of ribs by the force “F” per rib in the chart below, compare this to the force required, and loosen or tighten the belt as needed.

Run the drive briefly to seat the belt, and recheck the tension. At least one sheave should be freely rotating during the tensioning procedure.

### Rib Ace Tensioning

Belt Cross Section	Small Sheave Diameter Range	Force “F” lbs./Rib
J	1.32 - 1.67	0.4
J	1.77 - 2.20	0.5
J	2.36 - 2.95	0.6
L	2.95 - 3.74	1.7
L	3.94 - 4.92	2.1
L	5.20 - 6.69	2.5
M	7.09 - 8.82	6.4
M	9.29 - 11.81	7.7
M	12.40 - 15.75	8.8

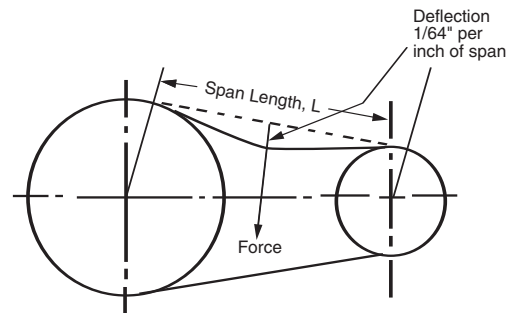
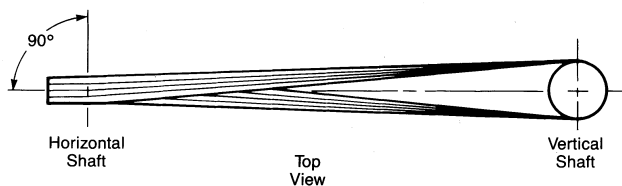

Figure 2

## Quarter Turn Drives

Quarter turn V-belt drives are used to transmit power from a horizontal shaft to a vertical shaft, or vice versa. For maximum service on these drives, follow these guidelines:

1. Deep groove sheaves should always be used. Use individual — not banded — belts.
2. Center distance should be equal to 5 1/2 times the sum of the diameter of the large sheave plus its face width. This long center distance is necessary to insure the entry angle of the belts into the sheave grooves is 5° or less.
3. Speed ratio should not exceed 2.5:1. Greater speed ratios require such long center distances that a two-stage drive may be more feasible.
4. The center line of the horizontal shaft on the quarter turn drives should be above the center of the vertical shaft sheave.



## V-Flat Drives

Usually a converted flat belt drive, a V-flat drive has one V-grooved sheave and one flat pulley. For best results, follow these recommendations:

1. The arc of contact, or belt wrap, determines if a V-flat drive is practical. Use the formula  $A = \frac{D-d}{C}$ , where D is the large sheave diameter, d is the small sheave diameter, and C is the center distance. If A is between 0.5 and 1.5, the V-flat drive will have sufficient wrap to transmit the load under the proper tension.
2. The flat pulley should have a straight face for best operation. If the pulley is crowned, it should not exceed 1/4" per foot (on the diameter) of face width. When possible, remove the crown by machining.
3. Shock loads and/or pulsating loads should be avoided on V-flat drives.
4. Bando Combo (banded) belts are ideally suited for V-flat drives. Power King® belts may also be used. Consult Bando if Power Ace® belts are considered for use on V-flat drives.

## Idlers

### V-Belt Idlers

An idler is a grooved sheave or a flat pulley that does not transmit power. Idlers create additional bending stresses within a belt, and thus reduce horsepower ratings. Take this into account during drive design so belt life isn't reduced.

Idlers are generally used under these circumstances:

- To tension and provide for take-up on a fixed center drive
- To dampen vibration in a long belt span
- To increase the arc of contact on a small sheave so the belt won't slip
- To guide belts around obstructions and to turn corners
- To function as clutching sheaves

### Inside Idler

A grooved idler on the inside of the belts, on the slack side of the drive, is usually preferable to a back side idler. Place the idler close to the large sheave so the arc of contact is not greatly reduced on the small sheave. The diameter of the idler should be as large as, or larger than, the smallest loaded sheave.

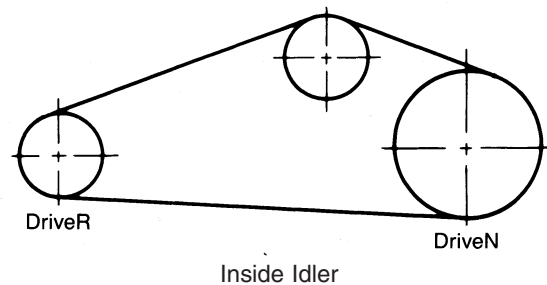

### Back Side Idler

A back side (or outside) idler, which is always flat because it contacts the top of the belts, increases the arc of contact on both sheaves, but it forces a backward bend in the belts. Such a bend will shorten life.

The diameter of a back side idler should be at least 1 1/2 times the diameter of the smallest loaded sheave. Locate the idler as close to the small sheave as possible, on the slack side of the drive.

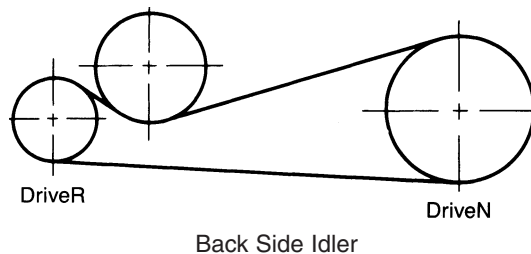

### Timing Belt Idlers

On timing belt drives, idlers are sometimes used for tensioning, power take-off, or functional purposes. For maximum belt life, follow these guidelines:

- As with V-belts, install idler on slack side of drive.
- Inside idlers must be grooved. Back side (outside) idlers should be flat, uncrowned pulleys.
- Fixed idlers, rather than spring-loaded idlers, are recommended.

# Troubleshooting Guide

Problem	Cause	Solution
<b>V Belts</b>		
<b>Short Belt Life</b>		
Rapid failure with no visible reason	Worn sheave grooves (Check with groove gauge)	Replace sheaves
	Tensile cords damaged through improper installation	Replace all belts with a new set, properly installed
	Underdesigned drive	Redesign drive
	Wrong type or cross section belt	Replace all belts with correct type, properly installed
	Sheave diameter too small	Redesign drive
	Foreign substance caught between belts and sheave	Shield the drive
Soft, slick, swollen sidewalls. Low adhesion between plies	Oil or grease on belt or sheave	Clean belts and sheaves with degreasing agent or detergent and water. Remove source of oil or grease
Dry, hard sidewalls. Low adhesion between plies. Cracked belt bottom	High temperature	Remove heat source. Improve ventilation
	Worn or damaged sheaves	Replace sheaves
Deterioration of rubber	Belt dressing	Don't use belt dressing. Clean belts and sheaves with degreasing agent or detergent and water. Tension belts properly
Rapid sidewall wear	Worn or damaged sheaves	Replace sheaves
Broken belts	Foreign object in drive	Shield drive
Spin burns	Belts slip under starting or stalling load	Retension drive
	Sheave diameter too small	Redesign drive
	Load miscalculated – drive underdesigned	Redesign drive
Cracked bottom	Sheave diameter too small	Redesign drive
	Back side idler too small	Replace with an inside idler on slack side, or redesign
	Slippage	Retension drive
	High temperature	Remove heat source. Improve ventilation
Cut bottom	Belt ran off sheave	Check tension and alignment
	Foreign object in drive	Shield drive
	Improper installation	Replace all belts with a new set, properly installed

Problem	Cause	Solution
Extreme cover wear, worn corners	Belt rubs against guard or other obstruction	Remove obstruction or realign drive
	Improper tension	Retension drive
	Dirt on belt	Clean belt, shield drive
	Sheaves rusted, sharp corners or burrs on sheaves	Repair or replace sheaves
	Sheaves misaligned	Align sheaves

## Belt Stretch

Belts stretch unequally	Misaligned drive	Realign drive
	Tensile cord broken from improper installation	Replace all belts with a new set, properly installed
Belts stretch equally	Insufficient take-up allowance	Check take-up and follow guidelines
	Overloaded or underdesigned drive	Redesign drive

## Belt Turnover

	Severe vibration and shock loads	Use Bando Combo belts
	Foreign material in grooves	Shield drive
	Misaligned sheaves	Realign sheaves
	Worn sheave grooves (Check with groove gauge)	Replace sheaves
	Tensile cord broken from improper installation	Replace all belts with a new set, properly installed
	Belt undertensioned	Retension drive
	Incorrectly placed flat idler pulley	Position idler on slack side of drive, as close as possible to driveR sheave

## Belt Noise

	Belt slip	Retension
	Misaligned sheaves	Realign sheaves
	Wrong belt type	Replace cut edge with wrapped belt

## Belt Vibration

	Shock loads	Use Bando Combo belts
	Incorrectly placed flat idler pulley	Position idler on slack side of drive, as close as possible to driveR sheave
	Distance between shafts too long	Install idler
	Belt lengths uneven	Replace with Bando <b>BAN/SET</b> ® belts
	Belts too loose	Retension drive

## Severe Slippage

	Spin burns	Retension drive
	Too few belts	Redesign drive



# Troubleshooting Guide

Problem	Cause	Solution
	Arc of contact too small	Install back side idler on slack side, or use timing belt
	Oil or water on belt	Clean belts and sheaves, shield drive

## Improper DriveN Speed

Incorrect driveR to driveN ratio	Design error	Redesign drive
----------------------------------	--------------	----------------

## Installation Problems

Belts too long or short at installation	Design and/or belt selection error	Check design and selection
Belts mismatched at installation	Mixed used and new belts	Replace all belts with new belts
	Mixed belts from different manufacturers	Replace with belts from the same manufacturer
	Worn sheave grooves	Replace sheaves

## Hot Bearings

Drive overtensioned	Worn sheave grooves, belts bottom out	Replace sheaves
Sheave diameter too small	Design error	Redesign drive
Bad bearings	Underdesigned or poor maintenance	Check bearing design and maintenance
Drive undertensioned	Belts slip and cause heat build-up	Retension drive
Sheaves too far out on shaft	Design error or obstruction	Place sheaves as close to bearings as possible

## Combo (Banded) Belts

Tie band cut and/or separated. Belts riding out of sheave grooves	Worn sheaves (Check with groove gauge)	Replace sheaves
	Sheave misalignment	Realign sheaves
	Belts undertensioned	Retension drive
	Foreign object in drive	Shield drive
All belts separated from tie band	Damage from belt guard	Adjust guard
	Worn idler sheave	Replace idler sheave
Frayed tie band	Obstruction on machine	Remove obstruction and realign drive
Blistered tie band	Foreign material between belts	Clean and shield drive
Cracked belt bottom	Slippage	Retension drive

## Timing Belts

Broken belts	Underdesigned drive	Redesign drive
	Sharp bend damaged tensile cord	Follow proper storage and handling procedures

Problem	Cause	Solution
	Belt was pried or forced on the drive	Follow proper installation guidelines
	Foreign object in drive	Shield drive
	Belt runs onto pulley flange	Align pulleys
Apparent belt stretch	Reduction of center distance or non-rigid mounting	Replace pulleys. Install cover if drive is dusty
	Pulley teeth poorly machined or worn	Increase deceleration time or redesign drive
	Sudden equipment stops	Increase deceleration time or redesign drive
	Belt doesn't engage pulley teeth	Retension drive
Tooth shear	Less than 6 teeth-in-mesh	Redesign drive, install back side idler, or use next smaller pitch
	Excessive load	Redesign drive
Tensile or tooth shear failure	Pulley diameter too small	Increase pulley diameter or use next smaller pitch
	Exposure to acid or caustic atmosphere	Protect drive or ask Bando about special construction belt
Excessive pulley tooth wear (on pressure face and/or O.D.)	Drive overload and/or excess belt tension	Reduce installation tension and/or increase drive load carrying capacity
	Insufficient hardness of pulley material	Use harder material or surface-harden pulley
Excessive jacket wear between teeth, exposing tensile cord	Excessive installation tension	Reduce installation tension
Excessive noise	Misalignment	Realign drive
	Excessive installation tension	Reduce tension
	Excessive load	Increase drive load carrying capacity
	Pulley diameter too small	Increase pulley diameter
Cracks in belt backing	High temperatures	Improve ventilation, remove heat source, or check with Bando for special construction belt
Softening of backing	Excess heat (over 200°F) and/or oil	Lower ambient temperature, protect from oil, or ask Bando about special belt construction
Excessive edge wear	Misalignment or non-rigid centers	Realign drive and/or reinforce mounting
	Bent flange	Straighten flange
Unmounting of flange or flange wear	Incorrect flange installation	Install flange correctly
	Misalignment	Realign drive

## Troubleshooting Examples

Here are some examples of belt failures described on pages 6 and 7.  
If you've encountered similar problems, check below for probable causes and solutions.

### V-Belts

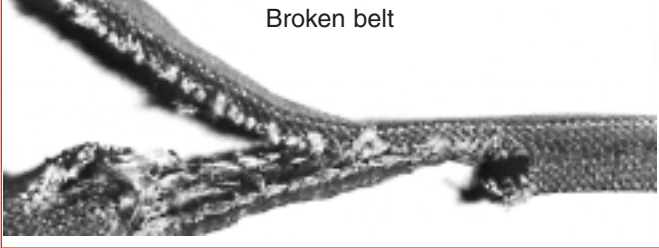
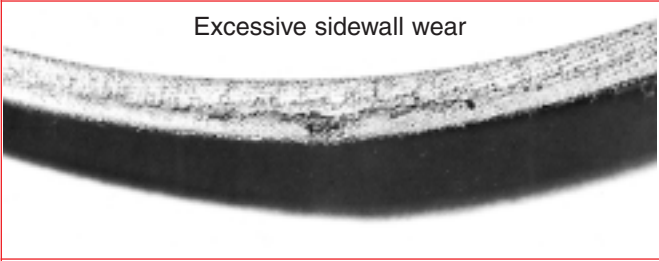
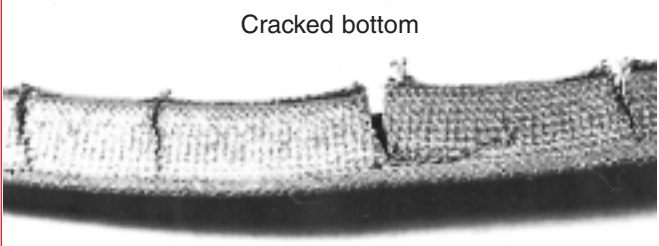
Problem	Probable Cause	Solution
 <p>Broken belt</p>	Foreign object in drive	Shield drive
 <p>Excessive sidewall wear</p>	Worn or damaged sheaves	Replace sheaves
 <p>Cracked bottom</p>	Sheave diameter too small Back side idler diameter too small Slippage High temperature	Redesign drive Replace with an inside idler on slack side, or redesign Retension drive Remove heat source. Improve ventilation

### Timing Belts

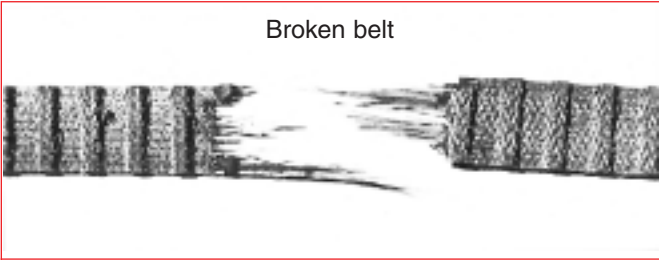
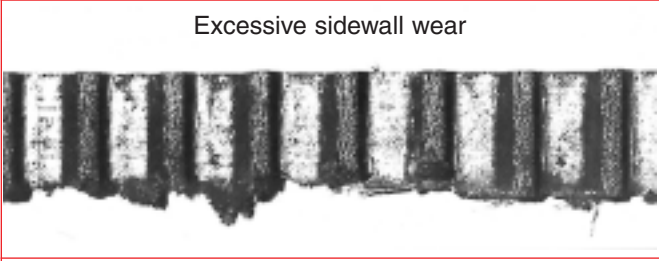
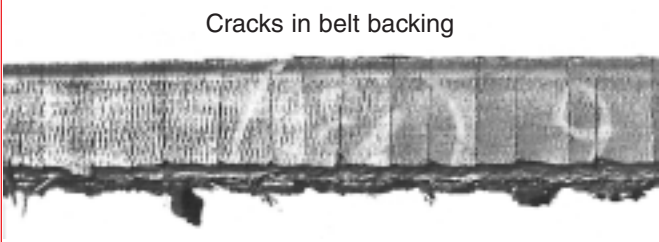
 <p>Broken belt</p>	Underdesigned drive Crimp caused tensile cord damage Belt was pried or forced on the drive Foreign object in drive Belt ran onto pulley flange	Redesign drive Follow proper storage and handling procedures Follow proper installation guidelines Shield drive Align pulleys
 <p>Excessive sidewall wear</p>	Misalignment or non-rigid centers Bent flange	Align drive and/or reinforce mounting Straighten flange
 <p>Cracks in belt backing</p>	High temperatures	Remove heat source. Improve ventilation. Check for special belt construction

# The Bando Family of Industrial Power Transmission Products



**Power King® Conventional**  
(A, B, C, D, E)

Classical section belt designed to cut operating costs and reduce maintenance on multiple belt industrial drives.

**BAN/SET®**



**Power Ace® Narrow**  
(3V, 5V, 8V)

Extra efficient narrow section belt provides high horsepower ratings. You use fewer belts per drive, and save weight, space, and cost.

**BAN/SET®**



**Power King® Cog (AX, BX, CX)**  
**Power Ace® Cog (3VX, 5VX)**

Heat-dissipating cogs, designed to make belts run cooler and last longer, permit the use of smaller sheaves and more efficient, higher rpm motors.

**BAN/SET®**



**BAN/SET® Power King® Combo (B, C, D)**  
**Power Ace® Combo**  
(3V, 5V, 8V)

Stabilize belts that whip, flip over, or jump off sheaves with these individual belts, permanently bonded together with a tough, oil and heat resistant tie band.



**Power Max™ Variable Speed**  
(Popular Sizes)

Precision molded cogs provide flexibility to reduce heat build-up and give a wide range of speed ratios on variable speed pulley applications.



**Rib Ace® V-Ribbed**  
(J, L, M)

Reduce drive costs with this thin, flexible, multiple V-ribbed belt. Use smaller, less expensive sheaves for lighter, more compact, economical drives.



**Double V**  
(AA, BB, CC)

Used to transmit power from both sides of the belt on reverse bend, serpentine drives.



**Duraflex GL® (3L, 4L, 5L)**  
Oil and heat resistant rubber compounds and extra strong polyester tensile cord found in heavy duty belts are used to give long, economical service on fractional horsepower drives.



**Metric-V**  
(SPZ, SPA, SPB, SPC)

Narrow wedge design permits higher speed ratios, shorter center distances and more economical compact drives.

**BAN/SET®**



**Synchro-Link® Timing Belts**  
(MXL, XL, L, H, XH, XXH Rubber)  
(XL, L, T2.5, T5, T10 Polyurethane)  
Precise design and tight manufacturing tolerances assure belt teeth mesh smoothly with pulley grooves for non-slip, positive performance on synchronous drives.

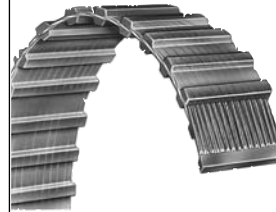

**Synchro-Link® Double Sided Timing Belts** (XL, L, H Rubber)  
(MXL, XL, T5, T10 Polyurethane)  
Designed for synchronized serpentine drives, these belts position teeth on both sides of the belt to provide smooth, precise performance under exacting drive conditions.



**Synchro-Link® HT, XP, STS**  
(2MM, 3MM, 4.5MM, 5MM, 8MM, 14MM) Single and Double Sided  
Metric configurations for high torque, high horsepower applications.



**Banflex®**

Small cross section makes these belts the preferred choice where short centers, small diameter pulleys and high speeds are required on compact equipment designs.

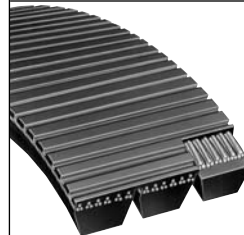

**Banflex® Combo**

Ideally suited for short centers and small diameter pulleys, "banded" construction minimizes or eliminates "turnover" problems associated with small cross section belts.



**Synchro-Link® Open Ended**  
(MXL, XL, L, H, T5, T10, 5MM, 8MM, 14MM)

Available in a broad range of constructions to satisfy applications such as conveying, positioning, metering, etc.



**Synchro-Link® Timing Belt Pulleys**

Timing belt pulleys are available in a wide range of sizes, materials, and types, including TL®, QD®, and minimum plain bore.