

# INDUSTRIAL ALTERNATING CURRENT MOTORS RPM AC

STEEL, CAST IRON, MILL AND TERMINAL BOARD CONDUIT BOX DIMENSIONS  
NEMA FRAMES RL210 thru RL280 and IEC FRAMES RDL132 thru RDL180  
NEMA FRAMES FL180 thru FL280 and IEC FRAMES FDL112 thru FDL180

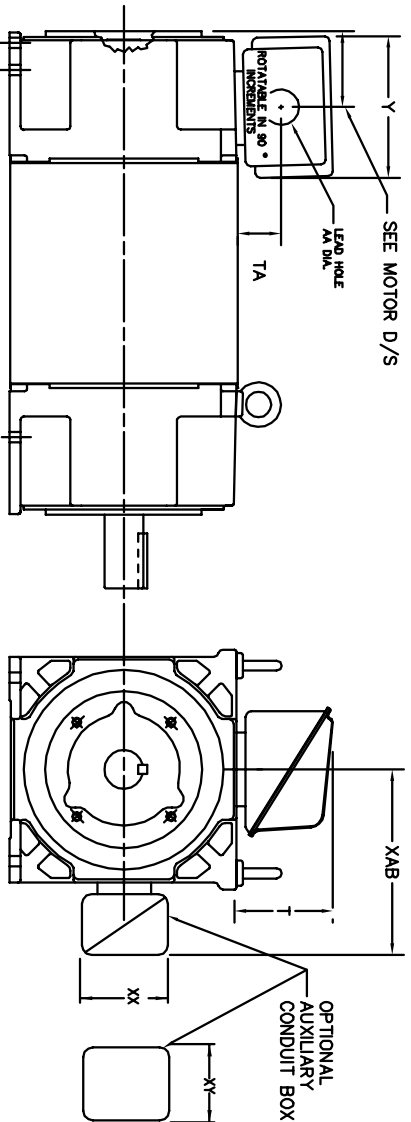

FRAME	TYPE	TERMINAL STRIP	AMPS	C/BOX	Y	TA	T	AA
FL180	STEEL	N	40	706320003A	5.00	1.62	3.00	1.12
FL180	STEEL	Y/N	75	706320005A	6.12	2.38	4.38	1.75/2.00
FL180	STEEL	N	208	706320007A	7.62	2.00	7.00	2.50/3.00
FL180	CAST IRON	Y/N	60	706320004C	5.75	2.38	4.38	1.0 TAP
FL180 & FDL11	MILL	Y	100	706310056A	7.75	2.30	4.40	PG29/PG16

FL210 & RL210	STEEL	N	61	0754520008	6.34	2.00	4.12	1.75
FL210 & RL210	STEEL	N	121	075454001AJ	7.69	2.38	5.25	1.94
FL210 & RL210	STEEL	N	305	706320016A	9.00	4.12	8.44	4.59
FL210 & RL210	CAST IRON	N	110	075460062B	7.25	2.50	5.25	1.5 TAP
FL210 & RL210	MILL	Y	100	706310056A	7.75	2.30	4.40	PG29/PG16
FL210 & RL210	MILL	Y	160	706310056B	9.00	3.06	5.40	PG36/PG16

FL250 & RL250	STEEL	N	61	0754520008	6.34	2.00	4.12	1.75
FL250 & RL250	STEEL	N	121	075454001AJ	7.69	2.38	5.25	1.94
FL250 & RL250	STEEL	N	305	706320016A	9.00	4.12	8.44	4.59
FL250 & RL250	CAST IRON	N	110	075460062B	7.25	2.50	5.25	1.5 TAP
FL250 & RL250	CAST IRON	N	210	706320013A	10.50	4.88	9.00	4.0 TAP
FL250 & RL250	MILL	Y	100	706310056A	7.75	2.30	4.40	PG29/PG16
FL250 & RL250	MILL	Y	160	706310056B	9.00	3.06	5.40	PG36/PG16
FL250 & RL250	MILL	Y	400	706310063B	14.39	7.43	12.15	BLANK

FL280 & RL280	STEEL	N	160	706320009A	7.25	3.50	7.06	2.50
FL280 & RL280	STEEL	N	305	706320016A	9.00	4.12	8.44	4.59
FL280 & RL280	STEEL	N	500	702658001C	14.62	7.56	12.70	5.00
FL280 & RL280	CAST IRON	N	140	706320012B	9.25	4.81	8.56	3.0 TAP
FL280 & RL280	CAST IRON	N	210	706320013A	10.50	4.88	9.00	4.0 TAP
FL280 & RL280	CAST IRON	N	510	706320014D	15.00	7.56	12.81	5.0 TAP
FL280 & RL280	MILL	Y	100	706310056A	7.75	2.30	4.40	PG29/PG16
FL280 & RL280	MILL	Y	160	706310056B	9.00	3.06	5.40	PG36/PG16
FL280 & RL280	MILL	Y	400	706310063B	14.39	7.43	12.15	BLANK

FRAME SIZE	OPTIONAL AUXILIARY CONDUIT BOX DIMENSIONS (MAXIMUM)								
	XAB	XX	XY	PART NUMBER	FRAME SIZE	XAB	XX	XY	PART NUMBER
FL20V/FL132/RL210V/RL132	7.38	4.25	4.25	602007-26-A	RL20V/FL132/RL210V/RL132	10.88	8.00	8.00	706310-3-B
FL250V/FL160/RL250V/RL160	8.44	4.25	4.25	602007-26-A	FL250V/FL160/RL250V/RL160	11.88	8.00	8.00	706310-3-B
FL280V/FL180/RL280V/RL180	9.12	4.25	4.25	602007-26-A	FL280V/FL180/RL280V/RL180	12.62	8.00	8.00	706310-3-B

- (1) "AA" CONDUIT
- (2) "AA" PIPE TAP
- (3) CUSTOMER TO PROVIDE HOLE FOR CONDUIT.
- (4) 2" DN -5A or 1" TAP DN -4C

TERMINAL BOX CAN BE ROTATED FOR LEAD OUTLET AT TOP, SIDES OR BOTTOM.  
TERMINAL BOX LOCATED ON OPPOSITE SIDE WHEN F-2, V-1, V-4, V-5, V-7,  
OR C-1 MOUNTING IS SPECIFIED. BOX LOCATED ON TOP WHEN SPECIFIED.

CUSTOMER IS RESPONSIBLE FOR DETERMINING THAT BALDOR'S PRODUCT WILL PERFORM SUITABLY IN THE INTENDED APPLICATION.

REV. DESC: REPLACE CONDUIT BOX TABLE	VERSION: 04	TDR: 000001047838
REV. LTR: D	REVISED: 11:46:16 10/19/2017	BY: RGGWT
FILE: \RGG\00003\692		
MTL: -		



DIM SHT NEMA RL210-RL280 FL180-FL280 IEC RDL132-RDL180