

**Climax Metal Products Company**

8141 Tyler Boulevard
Mentor, Ohio 44060
USA

Toll free: 800-542-6552

Phone: 440-585-0300

Fax: 800-860-5553

Email: sales@climaxmetal.com

Website: www.climaxmetal.com

ITEM # C-081-DT, SET SCREW COLLAR C-SERIES

Unplated Steel Set Screw Collar. Traditional cost effective collar design.



[Drawing](#) | [Specifications](#) |

Drawing

Dimensional Drawing

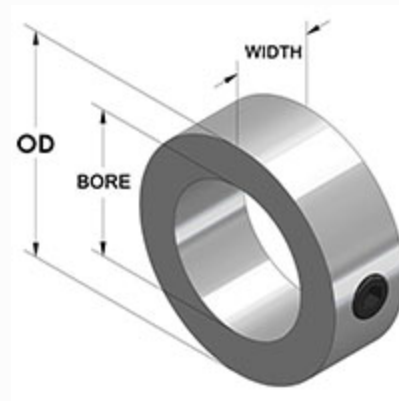

Set Screw Collar

Specifications

Bore	13/16 in
OD	1 1/4 in
Width	9/16 in
Style	Set Screw
Material	Steel, ASTM A108
Finish	Plain
Set Screw	Hex Socket Set Screw, 3A Thread, Steel, ASTM F912: 5/16-18 x 1/4
Approximate Weight	1.70 oz
UPC Code	044861002209
Downloads	Catalog Page

Competitor Part Number

Alternate Part Number	0403922 101784037 1570747 175D08444 227362 228083 6L013 C081DT
------------------------------	---