



Climax Metal Products Company

8141 Tyler Boulevard
Mentor, Ohio 44060
USA

Toll free: 800-542-6552

Phone: 440-585-0300

Fax: 800-860-5553

Email: sales@climaxmetal.com

Website: www.climaxmetal.com

ITEM # H1C-062-S, ONE-PIECE CLAMPING COLLAR RECESSED SCREW H1C-SERIES

Stainless Steel One-Piece Clamping Collar - Recessed Screw Head. Recessed Screw Head provides an outside surface free of major projections for safety. Design fully engages the shaft without marring. Greater axial holding power than set screw collars. Effective on hard & soft shafts.



[Drawing](#) | [Specifications](#) |

Drawing

Dimensional Drawing

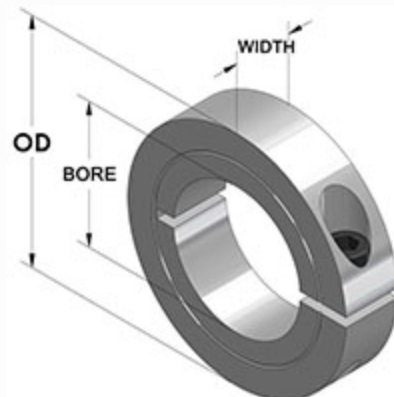

One-Piece Clamping Collar Recessed Screw

Specifications

Bore	5/8 in
OD	1 1/2 in
Width	13/32 in
Style	One-Piece Clamp
Material	Stainless Steel, ASTM A582
Finish	Plain
Clamp Screw	Hex Socket Cap Screw, 3A Thread, Stainless Steel, ASTM F837: 10-32 x 1/2
Recessed Screw	Yes
Approximate Weight	2.40 oz
UPC Code	044861177624
Downloads	Catalog Page

Competitor Part Number

Alternate Part Number	101784026
	1570547
	175D03052
	1S010
	213959
	213960
	213961
	34423
	890529
	CSSC62
	H1C062S