



Climax Metal Products Company

8141 Tyler Boulevard
Mentor, Ohio 44060
USA

Toll free: 800-542-6552

Phone: 440-585-0300

Fax: 800-860-5553

Email: sales@climaxmetal.com

Website: www.climaxmetal.com

ITEM # H1C-225, ONE-PIECE CLAMPING COLLAR RECESSED SCREW H1C-SERIES

Black Oxide Plated Steel One-Piece Clamping Collar - Recessed Screw Head. Recessed Screw Head provides an outside surface free of major projections for safety. Design fully engages the shaft without marring. Greater axial holding power than set screw collars. Effective on hard & soft shafts.



[Drawing](#) | [Specifications](#) |

Drawing

Dimensional Drawing

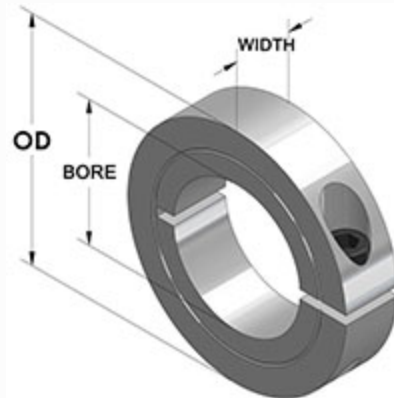

One-Piece Clamping Collar Recessed Screw

Specifications

Bore	2 1/4 in
OD	3 1/2 in
Width	5/8 in
Style	One-Piece Clamp
Material	Steel, ASTM A108
Finish	Black Oxide
Clamp Screw	Hex Socket Cap Screw, 3A Thread, Steel, ASTM A574: 5/16-24 x 1
Recessed Screw	Yes
Approximate Weight	14.90 oz
UPC Code	044861155226
Downloads	Catalog Page

Competitor Part Number

Alternate Part Number	101782008
	1570036
	175D03204
	1L204
	214186
	214187
	214188
	34369
	908434
	CSC225
	H1C225