



Climax Metal Products Company

8141 Tyler Boulevard
Mentor, Ohio 44060
USA

Toll free: 800-542-6552

Phone: 440-585-0300

Fax: 800-860-5553

Email: sales@climaxmetal.com

Website: www.climaxmetal.com

ITEM # H1C-325, ONE-PIECE CLAMPING COLLAR RECESSED SCREW H1C-SERIES

Black Oxide Steel One-Piece Clamping Collar. Design fully engages the shaft without marring. Greater axial holding power than set screw collars. Effective on hard & soft shafts.



[Drawing](#) | [Specifications](#) |

Drawing

Dimensional Drawing

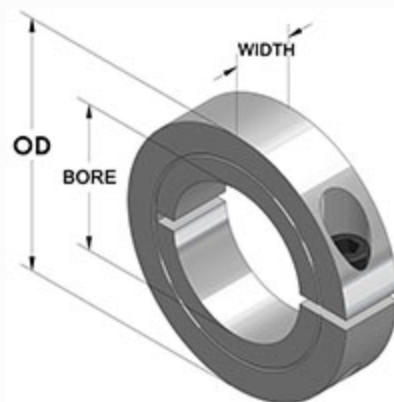

One-Piece Clamping Collar Recessed Screw

Specifications

Bore	3 1/4 in
OD	4 1/2 in
Width	7/8 in
Style	One-Piece Clamp
Material	Steel, ASTM A108
Finish	Black Oxide
Clamp Screw	Hex Socket Cap Screw, 3A Thread, Steel, ASTM A574: 3/8-24 x 1
Recessed Screw	No
Approximate Weight	27.30 oz
UPC Code	044861993279
Downloads	Catalog Page

Competitor Part Number

Alternate Part Number	0404396
	101948043
	175D31001
	1L304
	214294
	2758581
	2774589
	7L304
	H1C325