

PE145TC-2-4C

GENERAL PURPOSE ELECTRIC MOTOR

NEMA PREMIUM EFFICIENCY

THREE PHASE, TOTALLY ENCLOSED FAN COOLED - C-FLANGE W/ FEET

INVERTER DUTY 10:1 CT; 20:1 VT - NEMA MG1 PART 31

Factory Certified for T2B Class I, Division II, Groups A,B,C & D and Class II, Division II, Groups F & G

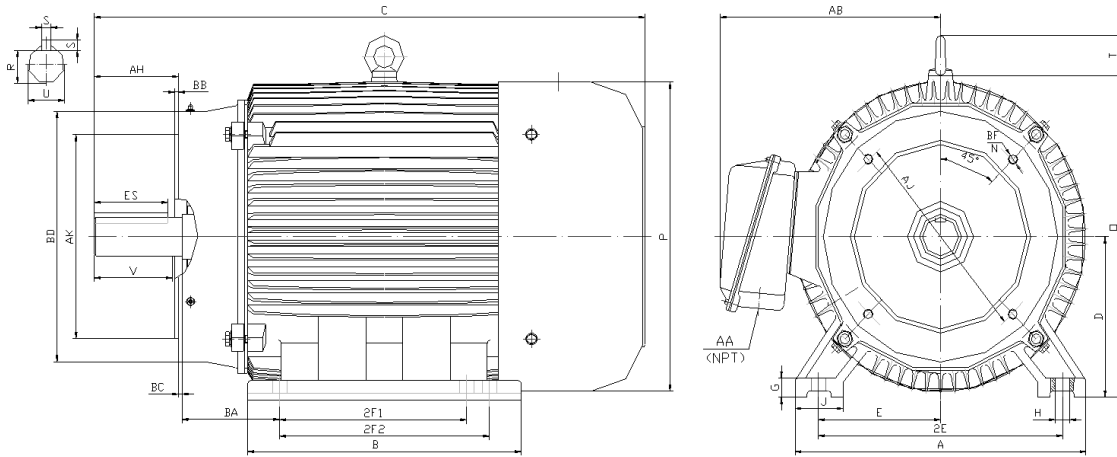

DIMENSIONS

HP	RPM	Frame	MOUNTING														
			A	B	C	D	G	H	J	E	2E	2F1	2F2	O	P	T	BA
2	1800	145TC	7.00	7.20	14.60	3.50	0.50	0.34	1.40	2.75	5.50	4.00	5.00	7.10	6.95	0.00	2.25

FLANGE							Shaft Extension, Key Set						Conduit Box		Bearings		Mount
AH	AJ	AK	BB	BC	BD	BF	U	V	R	S	ES	N-W	AA	AB	DE	ODE	
2.12	5.875	4.50	0.16	0.12	6.50	4*3/8-16	0.875	2	0.771	0.188	1.41	NA	0.75	6.10	6205-ZZ	6205-ZZ	F1

BEARING LUBRICATION: The bearings come lubricated with Mobil Polyrex EM Polyurea Grease.





PE145TC-2-4C

GENERAL PURPOSE ELECTRIC MOTOR

NEMA PREMIUM EFFICIENCY

THREE PHASE, TOTALLY ENCLOSED FAN COOLED - C-FLANGE W/ FEET

INVERTER DUTY 10:1 CT; 20:1 VT - NEMA MG1 PART 31







Factory Certified for T2B Class I, Division II, Groups A,B,C & D and Class II, Division II, Groups F & G

PERFORMANCE DATA

HP	RPM	Frame	Voltage	Frequency (Hz)	Full Load S.F.	Insulation Class	NEMA Design	Slip (%)	NEMA Code	Enclosure Type	IP Rating	Max. Ambient
2	1745	145TC	208-230/460	60	1.15	F	C	3.1	L	TEFC	55	40° C

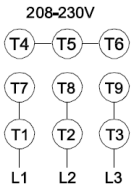
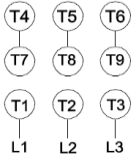
Amps (460V)		Efficiency (%)				Power Factor			Torque (ft-lb)			DE Bearing	ODE Bearing	Connection	Weight (lbs.)
FLA	LRA	100%	75%	50%	Min.	100%	75%	50%	FLT	LRT %	BDT %	6205-ZZ	6205-ZZ	9 Lead 2Y/Y	51
3.1	25.0	86.5	86.5	84.5	84.0	0.720	0.650	0.520	6.05	290	300				

NAME PLATE

 										CONNECTION DIAGRAMS 208-230V 		
CAT NO: PE145TC-2-4C		FRAME 145TC			PHASE 3							
HZ 60	S.F. 1.15	HZ 50	S.F. 1.0	ENCL TEFC	IP 55							
HP 2	RPM 1745	HP 2	RPM 1415	DUTY CONT	DES C							
VOLTS 208-230/460		VOLTS 190/380			AMB 40° C	INS F						
FLA 6.6 - 6.2 / 3.1	FLA 7.0/3.5			DE BEARING 6205-ZZ								
CODE L	P.F. 0.72	CODE G	P.F. 0.79	ODE BEARING 6205-ZZ								
EFF 86.5	MIN 84.0	EFF 84	MIN 81.5	LUB: Mobil Polyrex EM								
MOTOR WEIGHT 51 LBS	CONNECTION 9 Lead 2Y/Y			SER NO								
General purpose use on industrial machinery installed in damp, dusty or dirty environments. Hernando, Mississippi										460V 		
   CC 082A												

APPLICATIONS:

General purpose use on pumps, fans, blowers, compressors, conveyors, material handling and other industrial machinery installed in damp, dusty or dirty environments.