

TOP VIEW

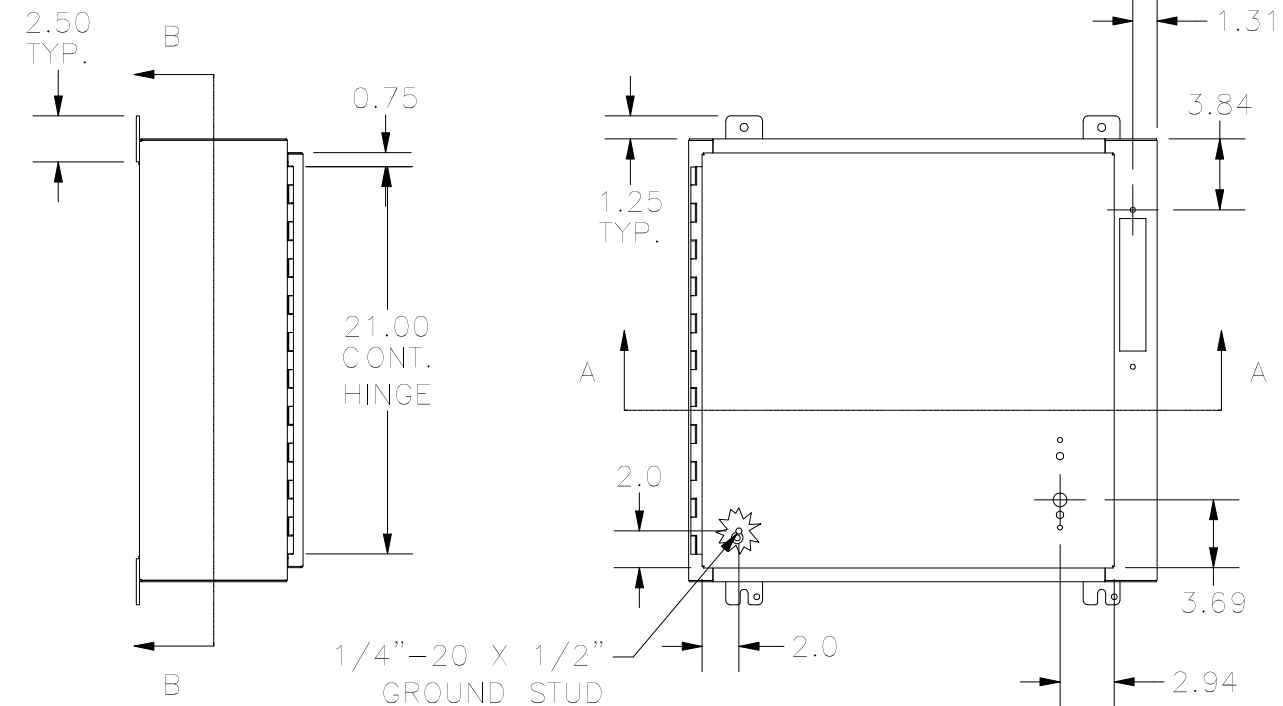

LEFT SIDE VIEW

FRONT VIEW

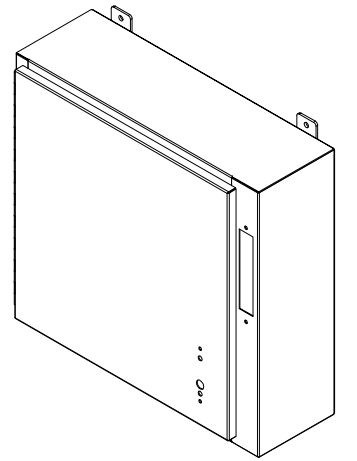
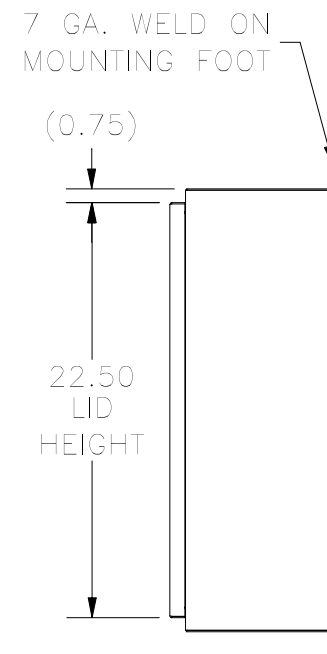

RIGHT SIDE VIEW

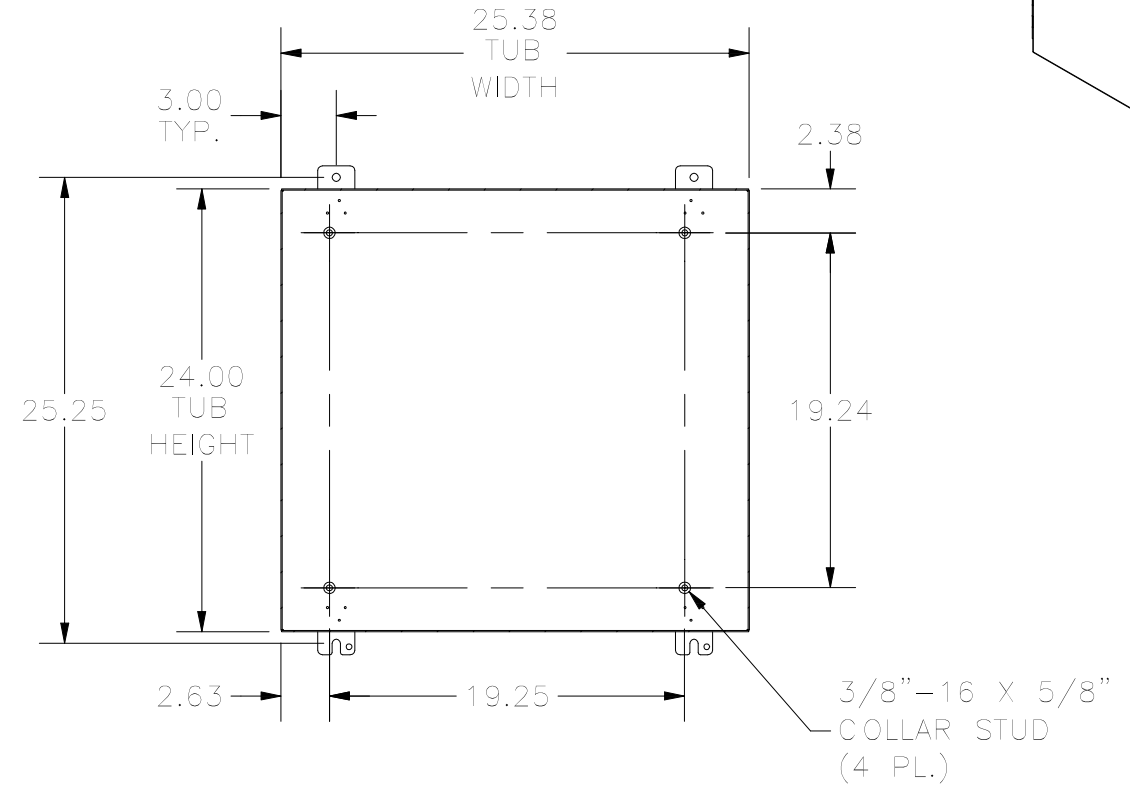

**SECTION B-B
(INSIDE BACK OF ENCLOSURE)**

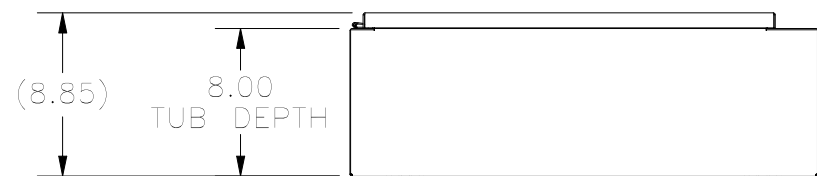

BOTTOM VIEW

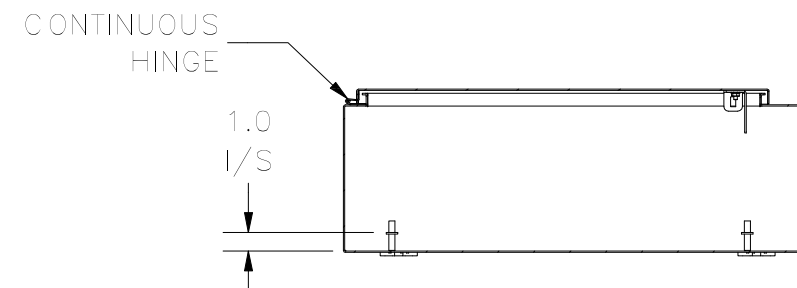

**SECTION A-A
(INSIDE TOP OF ENCLOSURE)**

PART#: ABN12242508
(DATA SUBJECT TO CHANGE WITHOUT NOTICE)

THIS DRAWING IS PROPERTY OF HUBBELL INC. WIEGMANN
ALL INFORMATION IS PROPRIETARY AND NOT TO BE DUPLICATED