

TOP VIEW

7 GA. WELD ON MOUNTING FOOT

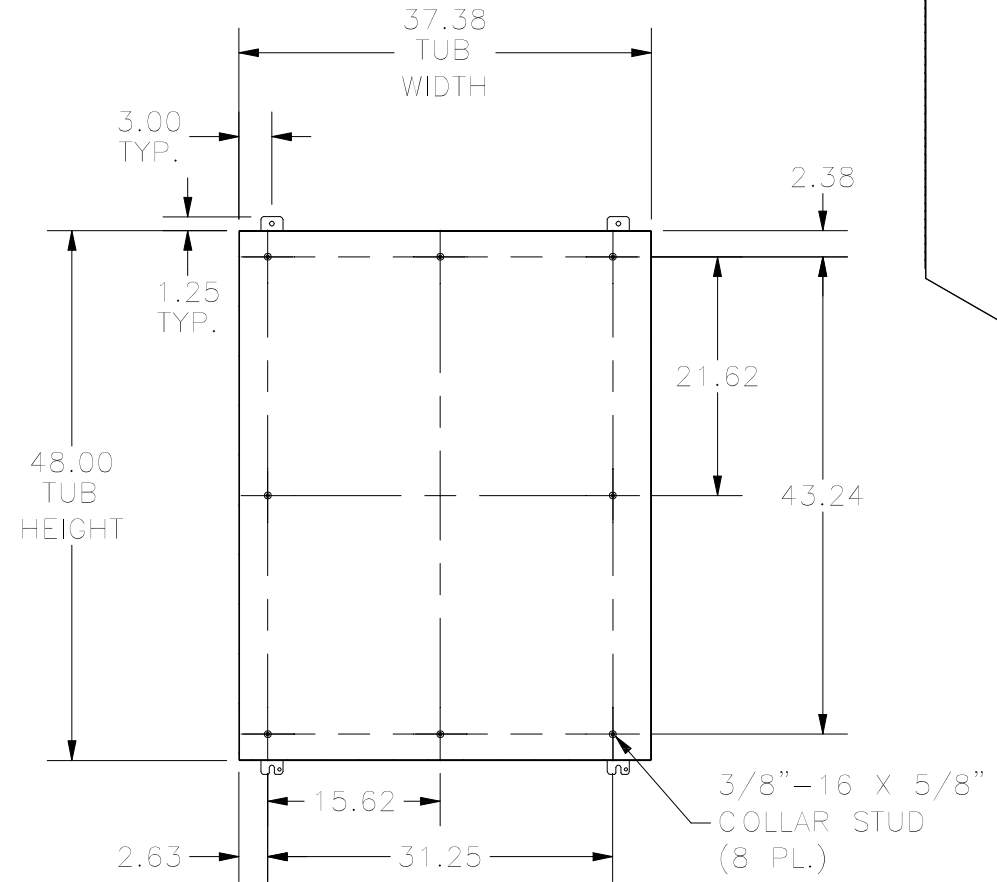

RIGHT SIDE VIEW

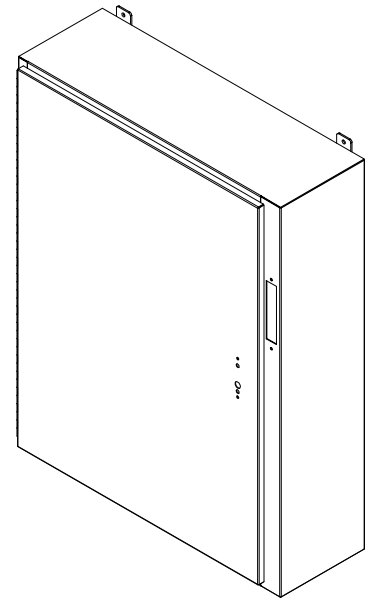

**SECTION A-A
(INSIDE BACK OF TUB)**

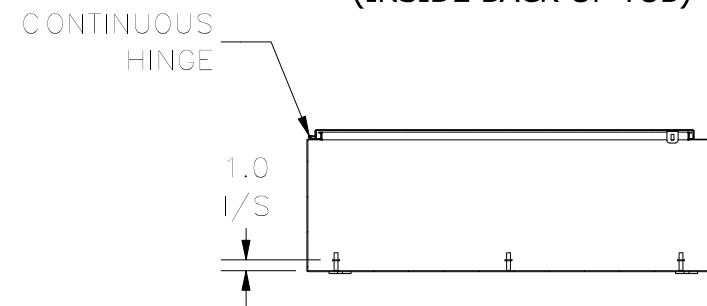

**SECTION B-B
(INSIDE TOP OF ENCLOSURE)**



LEFT SIDE VIEW

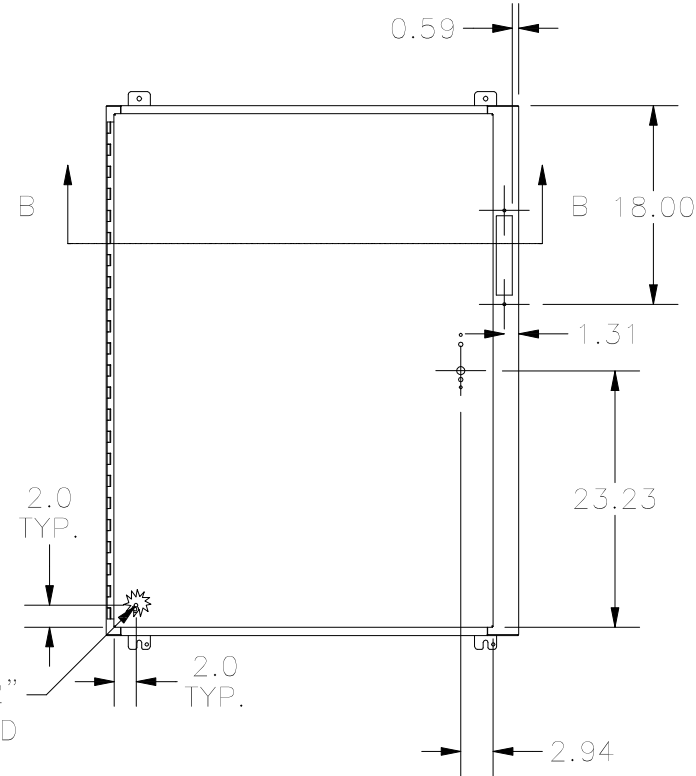

FRONT VIEW



BOTTOM VIEW

PART#: ABN12483812
(DATA SUBJECT TO CHANGE WITHOUT NOTICE)

THIS DRAWING IS PROPERTY OF HUBBELL INC. WIEGMANN
ALL INFORMATION IS PROPRIETARY AND NOT TO BE DUPLICATED