

Clamp Tees

3 Short Outlet Clamp Tees - B7MPS

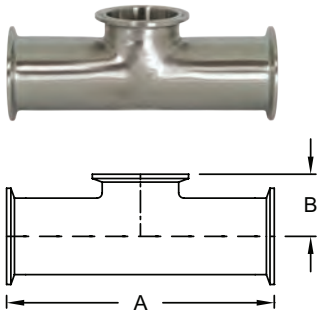

Tube OD	Dimensions		316L Stainless Steel	
	A	B	Part #	Price/E
1½"	5.500"	1.375"	B7MPS-R150	\$275.05
2"	7.000"	1.625"	B7MPS-R200	318.15
2½"	7.000"	1.875"	B7MPS-R250	341.10

3 Clamp Tees - B7MP

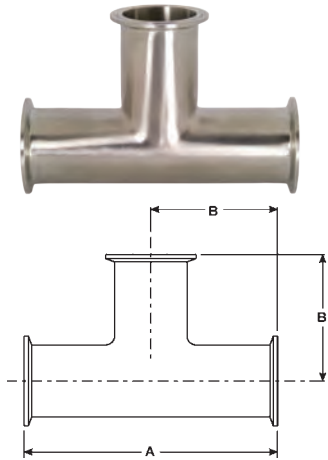

Tube OD	Dimensions		304 Stainless Steel		316L Stainless Steel	
	A	B	Part #	Price/E	Part #	Price/E
½"	4.750"	2.375"	---	---	B7MP-R50	\$164.90
¾"	5.000"	2.500"	---	---	B7MP-R75	145.85
1"	4.750"	2.375"	B7MP-G100	\$73.60	B7MP-R100	116.85
1½"	5.500"	2.750"	B7MP-G150	82.80	B7MP-R150	114.75
2"	7.000"	3.500"	B7MP-G200	102.60	B7MP-R200	133.20
2½"	7.000"	3.500"	B7MP-G250	131.05	B7MP-R250	178.65
3"	7.500"	3.750"	B7MP-G300	177.80	B7MP-R300	249.25
4"	9.000"	4.500"	B7MP-G400	243.90	B7MP-R400	335.50
6"	13.000"	6.500"	B7MP-G600	1127.50	B7MP-R600	1293.75
8"	15.750"	7.875"	B7MP-G800	2132.85	B7MP-R800	3471.60

3 Clamp Reducing Tees - B7RMP

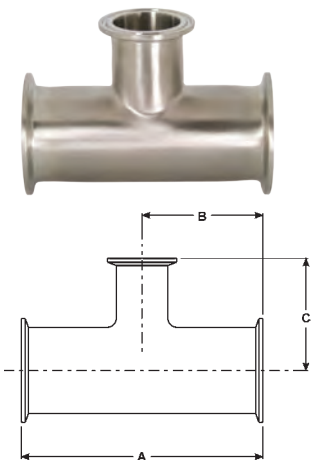

Tube OD	Dimensions			304 Stainless Steel		316L Stainless Steel	
	A	B	C	Part #	Price/E	Part #	Price/E
1" x ¾"	5.250"	2.625"	2.625"	---	---	B7RMP-R10075	\$222.60
1½" x ½"	5.750"	2.875"	2.875"	---	---	B7RMP-R15050	226.85
1½" x 1"	4.312"	2.156"	1.875"	---	---	B7RMP-R150100	178.75
2" x ½"	6.750"	3.375"	3.125"	---	---	B7RMP-R20050	687.05
2" x ¾"	6.750"	3.375"	3.125"	---	---	B7RMP-R20075	722.50
2" x 1"	5.125"	2.562"	2.125"	B7RMP-G200100	\$205.70	B7RMP-R200100	211.60
2" x 1½"	5.125"	2.562"	2.406"	B7RMP-G200150	167.25	B7RMP-R200150	229.75
2½" x 1½"	5.688"	2.844"	2.812"	B7RMP-G250150	221.20	B7RMP-R250150	309.00
2½" x 2"	5.688"	2.844"	2.812"	B7RMP-G250200	202.40	B7RMP-R250200	237.45
3" x 1½"	6.188"	3.093"	2.906"	B7RMP-G300150	271.25	B7RMP-R300150	418.15
3" x 2"	6.188"	3.093"	3.063"	B7RMP-G300200	228.85	B7RMP-R300200	342.45
4" x 1½"	8.125"	4.063"	3.406"	B7RMP-G400150	365.40	---	---
4" x 2"	8.125"	4.063"	3.563"	B7RMP-G400200	365.40	---	---

N