

UFACTURING • QUALITY • SERVICE • MANUFACTURING • QUALITY • SERVICE • MANUFACTURING • QUALITY • SERVICE • MANUFACTURING • QUALITY • SERVICE • MANUFACTURING • QUALITY • SERVICE • MANUFACTURING



The Right Connection®

Air Chief and Accessories

dixonvalve.com • Customer Service: 877.963.4966



Actual Size Profile Chart

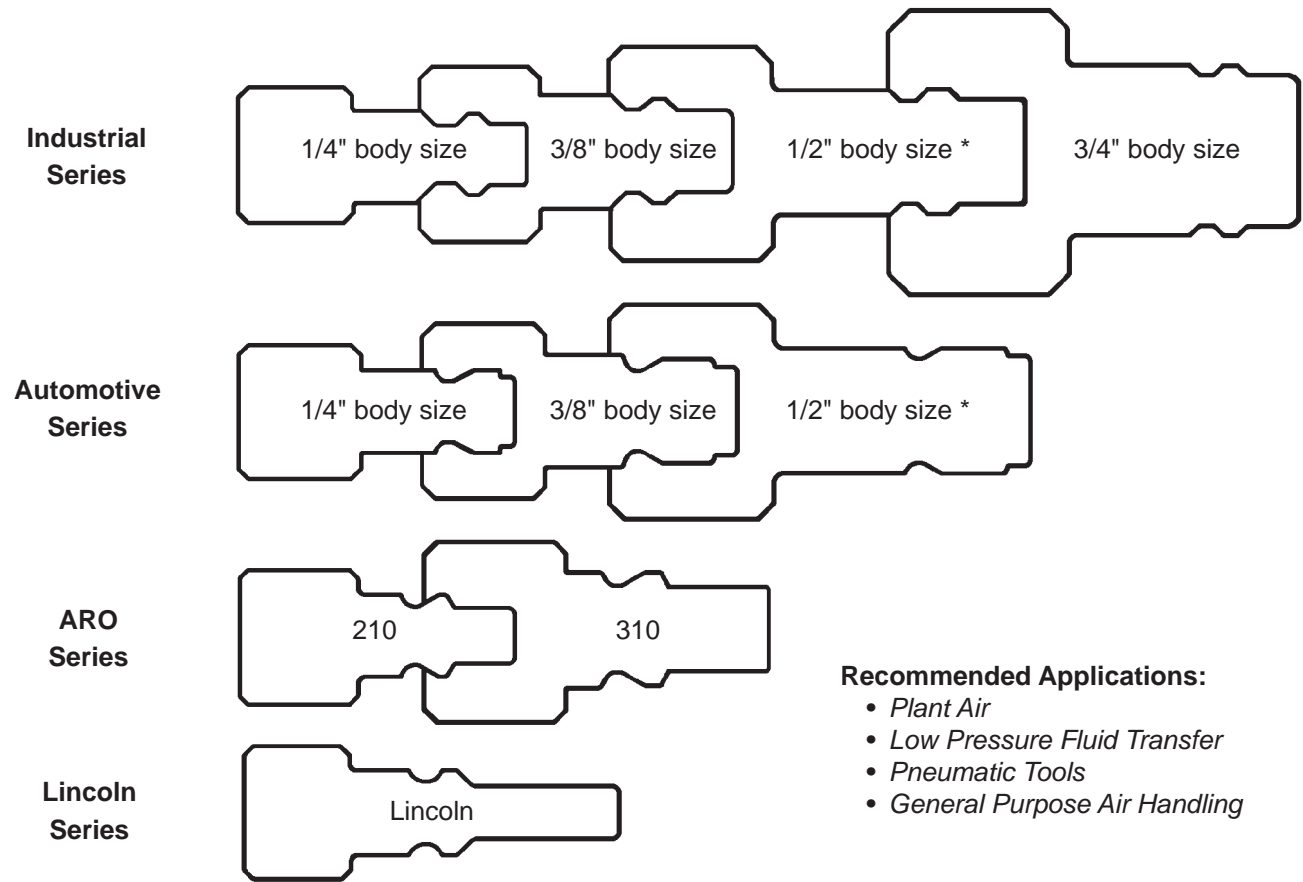

Recommended Applications:

- *Plant Air*
- *Low Pressure Fluid Transfer*
- *Pneumatic Tools*
- *General Purpose Air Handling*

* 1/2" industrial series may also interchange with 1/2" automotive series

SAFETY



A short length whip hose is recommended on impact tools connected with these couplers to prevent premature wear caused by excessive vibration.

Dixon's couplings and retention devices are designed to work safely for their intended use. The selection of the proper hose, coupling and retention device, and the proper application of the coupling to the hose are of utmost importance.

Users must consider the size, temperature, application, media, pressure and hose and coupling manufacturer's recommendations when selecting the proper hose assembly components. Dixon recommends that all hose assemblies be tested in accordance with the Association for Rubber Products Manufacturer's (ARPM) recommendations and be inspected regularly (before each use) to ensure that they are not damaged or have become loose. Visit ARPMINC.com for more information.

Where safety devices are integral to the coupling, they must be working and utilized. The use of supplementary safety devices such as safety clips or safety cables are recommended.

If any problem is detected, couplings must be removed from service immediately.

Dixon is available to consult, train and recommend the proper selection and application of all fittings we sell. We strongly recommend that distributors and end users make use of Dixon's Testing and Recommendation Services. Call 877.963.4966 or click dixonvalve.com to learn more.

Semi-Automatic Design

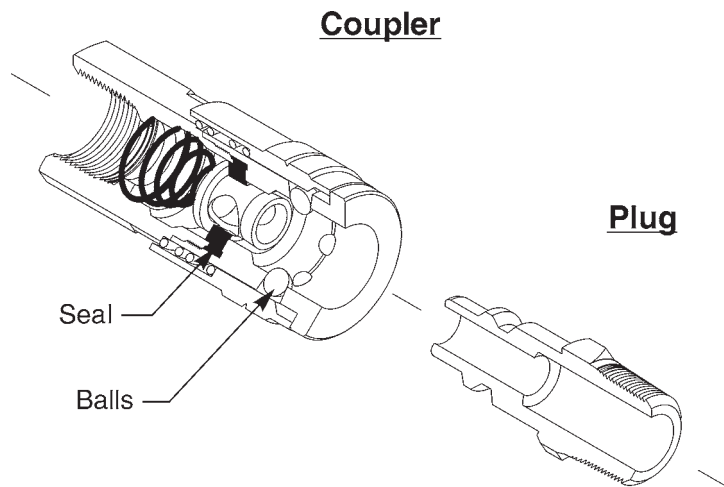

Semi-Automatic Quick-Connect Couplers are generally accepted as the fastest, easiest and most reliable means of joining low pressure pneumatic lines.

Hardened balls or pins engage a groove in the coupler plug to hold it securely against a soft positive seal gasket. This also permits the assembly to swivel, which helps to prevent kinking or twisting of the hose. A sliding sleeve releases the locking balls or pins when retracted, permitting the plug to be inserted or removed. The sleeve automatically returns to the locked position when released. An automatic shut-off valve in the coupler seals when being uncoupled, eliminating the need for a separate shut-off.

Automatic Design

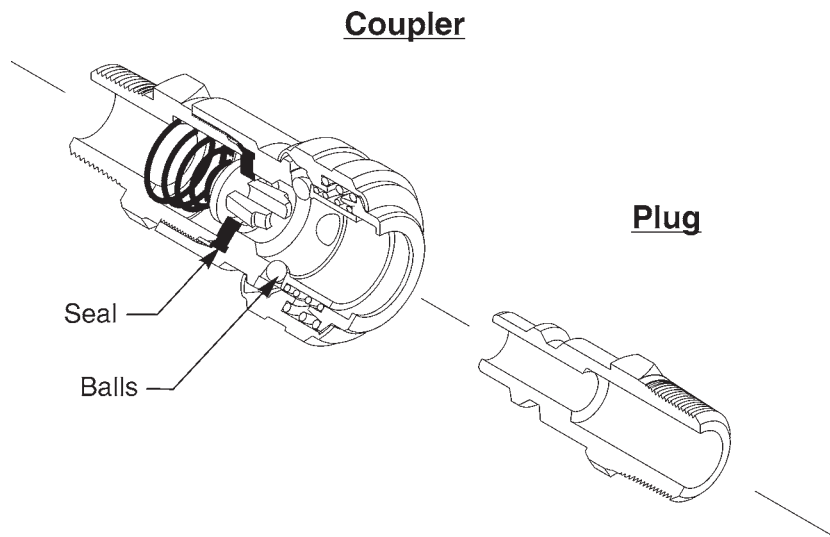

The Automatic Quick-Connect coupling design allows the user to connect and disconnect the fitting with one hand. The sleeve action is designed opposite of the conventional design which reduces the chance of accidental disconnect when pulled across obstacles.

Air Chief Universal Couplers

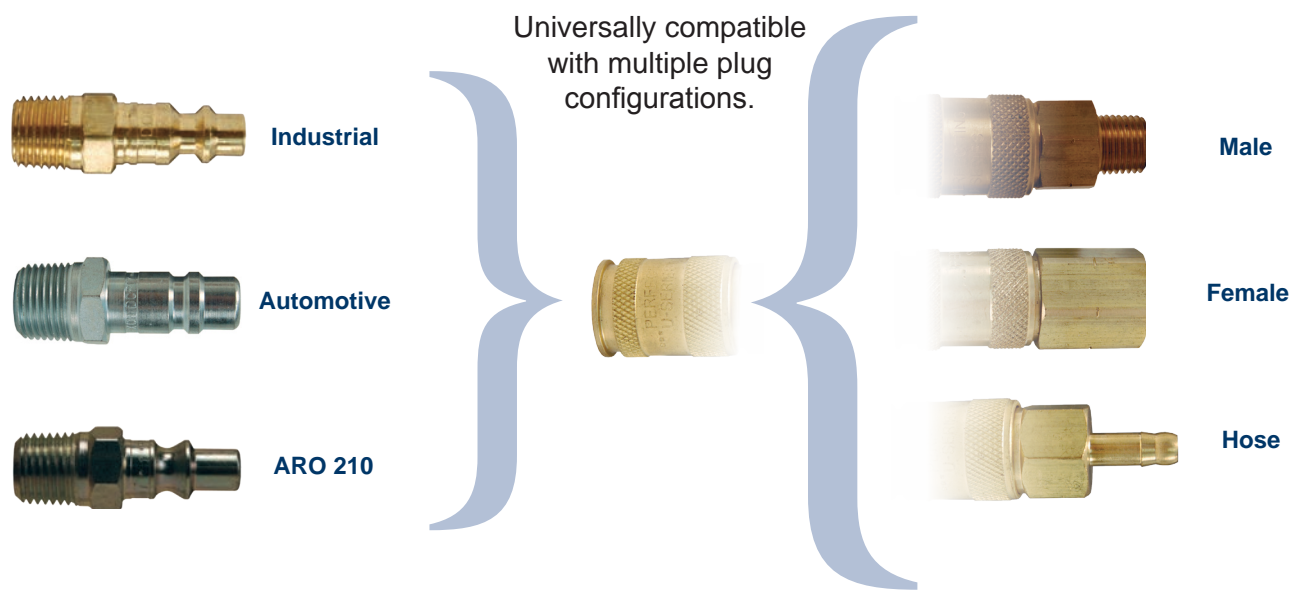

Air Chief Universal Quick-Connect Fittings

Features:

- the first 6-in-1 coupler available
- compatible with ARO 210, MIL-C-4109F, Truflate, Lincoln Interchange, Italian Standard and CEJN 320
- Euro-style valving ensures maximum flow performance and automatic connection with minimal force required
- sleeve-guard lip reduces the risk of accidental disconnection while in service
- maximum operating pressure: **300 PSI**

automatic - push to connect

Female Pipe Thread

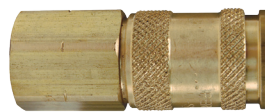

Body Size	Female NPT	Material	Flow Rating at 100 PSI	Part #
1/4"	1/4"	<i>brass</i>	37 CFM	<i>UDC20</i>
1/4"	3/8"	<i>brass</i>	37 CFM	<i>UDC2023</i>

Male Pipe Thread



Body Size	Male NPT	Material	Flow Rating at 100 PSI	Part #
1/4"	1/4"	<i>brass</i>	37 CFM	<i>UDC21</i>
1/4"	3/8"	<i>brass</i>	37 CFM	<i>UDC2103</i>

Standard Hose Barb



Body Size	Hose ID	Material	Flow Rating at 100 PSI	Part #
1/4"	1/4"	<i>brass</i>	37 CFM	<i>UDC2042</i>
1/4"	3/8"	<i>brass</i>	37 CFM	<i>UDC2044</i>

Ball Swivels

1/4" Ball Swivel Plugs

Features:

- threaded portion is brass
- plug and nut portion is nickel-plated hardened steel
- pressure rating: **250 PSI**

Male NPT Ball Swivel x Industrial Plug

Body Size	Male NPT	Part #	Opt Qty
1/4"	1/4"	<i>DCP21SWIV</i>	10

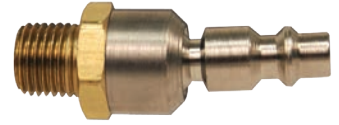

Male NPT Ball Swivel x ARO Plug

Body Size	Male NPT	Part #	Opt Qty
1/4"	1/4"	<i>DCP37SWIV</i>	10

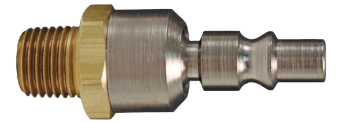

Male NPT Ball Swivel x Automotive Plug

Body Size	Male NPT	Part #	Opt Qty
1/4"	1/4"	<i>DCP1SWIV</i>	25



Standard Ball Swivels

Features:

- brass and hardened steel construction
- O-ring seals
- wobble action for increased flexibility with air driven tools

Hose Size	Male NPT	Part #	Opt Qty
1/4"	1/4"	<i>D444S</i>	25
3/8"	1/4"	<i>D446S</i>	25

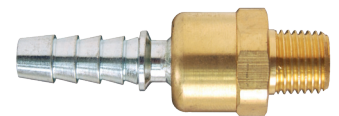

Push-On Ball Swivels

Feature:

- special barb design for secure grip in push-on type air hoses

Hose Size	Male NPT	Part #	Opt Qty
1/4"	1/4"	<i>D444SL</i>	25
3/8"	1/4"	<i>D446SL</i>	25

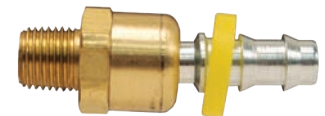

Air Chief Automotive Interchange Quick-Connect Plugs

Features:

- pressure rating: **300 PSI**
- temperature range: **-40°F to 250°F**
- interchange with popular makes of automotive quick-connect fittings such as Amflo, Dill, Milton and Truflate, some designs do not interchange with others, if you plan to interchange these couplings make sure you have plug ends with the proper configuration

Female Pipe Thread

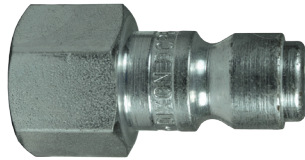

Body Size	Female NPT	Material	Flow Rating at 100 PSI	Part #	Opt Qty
1/4"	1/8"	steel	37 CFM	DCP221	25
1/4"	1/4"	steel	37 CFM	DCP2	20
1/4"	3/8"	steel	37 CFM	DCP223	20
3/8"	1/4"	steel	70 CFM	DCP8	10
3/8"	3/8"	steel	70 CFM	DCP6	10
3/8"	1/2"	steel	70 CFM	DCP624	10
1/2"	3/8"	steel	150 CFM	DCP1823	10
1/2"	1/2"	steel	150 CFM	DCP18	10
1/2"	3/4"	steel	150 CFM	DCP1826	10

Male Pipe Thread



Body Size	Male NPT	Material	Flow Rating at 100 PSI	Part #	Opt Qty
1/4"	1/8"	steel	37 CFM	DCP101	20
1/4"	1/4"	steel	37 CFM	DCP1	20
1/4"	3/8"	steel	37 CFM	DCP103	20
3/8"	1/4"	steel	70 CFM	DCP7	10
3/8"	3/8"	steel	70 CFM	DCP5	10
1/2"	3/8"	steel	150 CFM	DCP1703	10
1/2"	1/2"	steel	150 CFM	DCP17	20
1/2"	3/4"	steel	150 CFM	DCP1706	10

Standard Hose Barb



Body Size	Hose ID	Material	Flow Rating at 100 PSI	Part #	Opt Qty
1/4"	1/4"	steel	37 CFM	DCP142	20
1/4"	3/8"	steel	37 CFM	DCP144	20
3/8"	1/4"	steel	70 CFM	DCP542	10
3/8"	3/8"	steel	70 CFM	DCP544	25
1/2"	3/8"	steel	150 CFM	DCP1744	10
1/2"	1/2"	steel	150 CFM	DCP1745	10
1/2"	3/4"	steel	150 CFM	DCP1746	10

Push-On Hose Barb

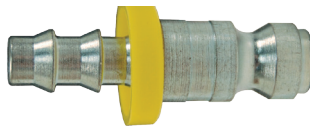

Body Size	Hose ID	Material	Flow Rating at 100 PSI	Part #	Opt Qty
1/4"	1/4"	steel	37 CFM	DCP142L	25
1/4"	3/8"	steel	37 CFM	DCP144L	25
3/8"	3/8"	steel	70 CFM	DCP544L	25

Air Chief Automotive Interchange Quick-Connect Couplers

Features:

- pressure rating: **300 PSI**
- temperature range: **-40°F to 250°F**
- interchanges with popular makes of automotive quick-connect fittings such as Amflo, Dill, Milton and Truflate, some makes do not interchange with any others, if you plan to interchange these couplings make sure you have plug ends with the proper configuration

Female Pipe Thread

Body Size	Female NPT	Material	Flow Rating at 100 PSI	Part #	Opt Qty
1/4"	1/8"	brass	37 CFM	DC221	25
1/4"	1/4"	brass	37 CFM	DC2	25
1/4"	3/8"	brass	37 CFM	DC223	10
3/8"	1/4"	steel	70 CFM	DC8	10
3/8"	3/8"	steel	70 CFM	DC6	10
3/8"	1/2"	steel	70 CFM	DC624	10
1/2"	3/8"	steel	150 CFM	DC1023	10
1/2"	1/2"	steel	150 CFM	DC10	10
1/2"	3/4"	steel	150 CFM	DC1026	10

semi-automatic
pull sleeve to connect

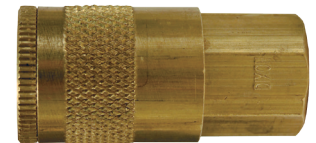

Male Pipe Thread

Body Size	Male NPT	Material	Flow Rating at 100 PSI	Part #	Opt Qty
1/4"	1/8"	brass	37 CFM	DC101	10
1/4"	1/4"	brass	37 CFM	DC1	10
1/4"	3/8"	brass	37 CFM	DC103	10
3/8"	1/4"	steel	70 CFM	DC7	10
3/8"	3/8"	steel	70 CFM	DC5	10
3/8"	1/2"	steel	70 CFM	DC504	10
1/2"	3/8"	steel	150 CFM	DC903	10
1/2"	1/2"	steel	150 CFM	DC9	10
1/2"	3/4"	steel	150 CFM	DC906	10

semi-automatic
pull sleeve to connect

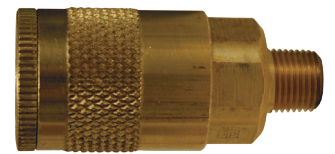

Standard Hose Barb

Body Size	Hose ID	Material	Flow Rating at 100 PSI	Part #	Opt Qty
1/4"	1/4"	brass	37 CFM	DC242	10
1/4"	5/16"	brass	37 CFM	DC243	10
1/4"	3/8"	brass	37 CFM	DC244	10
3/8"	1/4"	steel	70 CFM	DC642	10
3/8"	3/8"	steel	70 CFM	DC644	10
3/8"	1/2"	steel	70 CFM	DC645	10
1/2"	3/8"	steel	150 CFM	DC1044	10
1/2"	1/2"	steel	150 CFM	DC1045	10
1/2"	3/4"	steel	150 CFM	DC1046	10

semi-automatic
pull sleeve to connect



Push-On Hose Barb

Body Size	Hose ID	Material	Flow Rating at 100 PSI	Part #	Opt Qty
1/4"	1/4"	brass	37 CFM	DC242L	25
1/4"	3/8"	brass	37 CFM	DC244L	25
3/8"	1/4"	steel	70 CFM	DC642L	25
3/8"	3/8"	steel	70 CFM	DC644L	25

semi-automatic
pull sleeve to connect

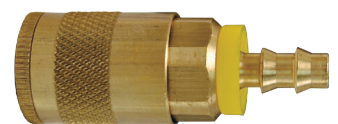

Air Chief Industrial Interchange Quick-Connect Couplers

Features:

- couplers shut-off when disconnected
- pressure rating: **300 PSI**
- temperature range: **-40°F to 250°F**
- interchanges with many other manufacturer's designs
- interchanges with MIL Spec. MIL-C-4109F/A-A-59439
- for air service only



Female Pipe Thread

Body Size	Female NPT	Material	Flow Rating at 100 PSI	Part #	Opt Qty
1/4"	1/8"	brass	37 CFM	DC2021	10
1/4"	1/4"	brass	37 CFM	DC20	10
1/4"	3/8"	brass	37 CFM	DC2023	10
3/8"	1/4"	steel	70 CFM	DC2622	10
3/8"	3/8"	steel	70 CFM	DC26	10
3/8"	1/2"	steel	70 CFM	DC2624	10
1/2"	3/8"	steel	150 CFM	DC1023	10
1/2"	1/2"	steel	150 CFM	DC10	10
1/2"	3/4"	steel	150 CFM	DC1026	10
3/4"	1/2"	brass	200 CFM	DC7024 ¹	1
3/4"	3/4"	brass	200 CFM	DC7026 ¹	1
3/4"	1"	brass	200 CFM	DC7028 ¹	1
1/4"	1/4"	303 stainless	37 CFM	DC20S	5
3/8"	3/8"	303 stainless	70 CFM	DC26S	5
1/2"	1/2"	303 stainless	150 CFM	DC10S	5

semi-automatic
pull sleeve to connect



Male Pipe Thread

Body Size	Male NPT	Material	Flow Rating at 100 PSI	Part #	Opt Qty
1/4"	1/8"	brass	37 CFM	DC2101	10
1/4"	1/4"	brass	37 CFM	DC21	10
1/4"	3/8"	brass	37 CFM	DC2103	10
3/8"	1/4"	steel	70 CFM	DC2502	10
3/8"	3/8"	steel	70 CFM	DC25	10
3/8"	1/2"	steel	70 CFM	DC2504	10
1/2"	3/8"	steel	150 CFM	DC903	10
1/2"	1/2"	steel	150 CFM	DC9	10
1/2"	3/4"	steel	150 CFM	DC906	10
3/4"	1/2"	brass	200 CFM	DC7104 ¹	1
3/4"	3/4"	brass	200 CFM	DC7106 ¹	1
3/4"	1"	brass	200 CFM	DC7108 ¹	1
1/4"	1/4"	303 stainless	37 CFM	DC21S	5
3/8"	3/8"	303 stainless	70 CFM	DC25S	5
1/2"	1/2"	303 stainless	150 CFM	DC9S	5

semi-automatic
pull sleeve to connect



Standard Hose Barb

Body Size	Hose ID	Material	Flow Rating at 100 PSI	Part #	Opt Qty
1/4"	1/4"	brass	37 CFM	DC2042	10
1/4"	5/16"	brass	37 CFM	DC2043	10
1/4"	3/8"	brass	37 CFM	DC2044	10
3/8"	1/4"	steel	70 CFM	DC2642	10
3/8"	3/8"	steel	70 CFM	DC2644	10
3/8"	1/2"	steel	70 CFM	DC2645	10
1/2"	3/8"	steel	150 CFM	DC1044	10
1/2"	1/2"	steel	150 CFM	DC1045	10
1/2"	3/4"	steel	150 CFM	DC1046	10
3/4"	1/2"	brass	200 CFM	DC7045 ¹	1
3/4"	3/4"	brass	200 CFM	DC7046 ¹	1
3/4"	1"	brass	200 CFM	DC7048 ¹	1
1/4"	1/4"	303 stainless	37 CFM	DC2042S	5
3/8"	3/8"	303 stainless	70 CFM	DC2644S	5
1/2"	1/2"	303 stainless	150 CFM	DC1045S	5

semi-automatic
pull sleeve to connect

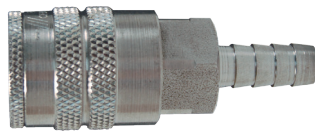

¹ 3/4" are automatic sleeve

Push-On Hose Barb

Body Size	Hose ID	Material	Flow Rating at 100 PSI	Part #	Opt Qty
1/4"	1/4"	brass	37 CFM	DC2042L	25
1/4"	3/8"	brass	37 CFM	DC2044L	25
3/8"	1/4"	steel	70 CFM	DC2642L	25
3/8"	3/8"	steel	70 CFM	DC2644L	25

semi-automatic
pull sleeve to connect

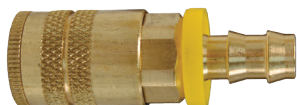

Air Chief Industrial Interchange Quick-Connect Couplers

Features:

- couplers shut-off when disconnected
- pressure rating: **300 PSI**
- temperature range: **-40°F to 250°F**
- interchanges with many other manufacturer's designs
- interchanges with MIL Spec. MIL-C-4109F/A-A-59439
- for air service only 

Female Pipe Thread

Body Size	Female NPT	Material	Flow Rating at 100 PSI	Part #	Opt Qty
1/4"	1/4"	brass	27 CFM	DCB20	24
1/4"	3/8"	brass	27 CFM	DCB2023	24
3/8"	1/4"	brass	45 CFM	DCB2622	12
3/8"	3/8"	brass	45 CFM	DCB26	12
3/8"	1/2"	brass	45 CFM	DCB2624	12
1/2"	3/8"	brass	91 CFM	DCB1023	6
1/2"	1/2"	brass	91 CFM	DCB10	6
1/2"	3/4"	brass	91 CFM	DCB1026	6
3/4"	1/2"	brass	200 CFM	DC7024	1
3/4"	3/4"	brass	200 CFM	DC7026	1
3/4"	1"	brass	200 CFM	DC7028	1
1/4"	1/4"	303 stainless	27 CFM	DCS20	5
3/8"	3/8"	303 stainless	45 CFM	DCS26	5
1/2"	1/2"	303 stainless	91 CFM	DCS10	5

automatic
push-to-connect



Male Pipe Thread

Body Size	Male NPT	Material	Flow Rating at 100 PSI	Part #	Opt Qty
1/4"	1/4"	brass	27 CFM	DCB21	24
1/4"	3/8"	brass	27 CFM	DCB2103	24
3/8"	1/4"	brass	45 CFM	DCB2502	12
3/8"	3/8"	brass	45 CFM	DCB25	12
3/8"	1/2"	brass	45 CFM	DCB2504	12
1/2"	3/8"	brass	91 CFM	DCB903	6
1/2"	1/2"	brass	91 CFM	DCB9	6
1/2"	3/4"	brass	91 CFM	DCB906	6
3/4"	1/2"	brass	200 CFM	DC7104	1
3/4"	3/4"	brass	200 CFM	DC7106	1
3/4"	1"	brass	200 CFM	DC7108	1
1/4"	1/4"	303 stainless	27 CFM	DCS21	5
3/8"	3/8"	303 stainless	45 CFM	DCS25	5
1/2"	1/2"	303 stainless	91 CFM	DCS9	5

automatic
push-to-connect



Standard Hose Barb

Body Size	Hose ID	Material	Flow Rating at 100 PSI	Part #	Opt Qty
1/4"	1/4"	brass	27 CFM	DCB2042	24
1/4"	3/8"	brass	27 CFM	DCB2044	24
3/8"	1/4"	brass	45 CFM	DCB2642	12
3/8"	3/8"	brass	45 CFM	DCB2644	12
3/8"	1/2"	brass	45 CFM	DCB2645	12
1/2"	3/8"	brass	91 CFM	DCB1044	6
1/2"	1/2"	brass	91 CFM	DCB1045	6
1/2"	3/4"	brass	91 CFM	DCB1046	6
3/4"	1/2"	brass	200 CFM	DC7045	1
3/4"	3/4"	brass	200 CFM	DC7046	1
3/4"	1"	brass	200 CFM	DC7048	1
1/4"	1/4"	303 stainless	27 CFM	DCS2042	5
3/8"	3/8"	303 stainless	45 CFM	DCS2644	5
1/2"	1/2"	303 stainless	91 CFM	DCS1045	5

automatic
push-to-connect



Air Chief Industrial Interchange Quick-Connect Plugs

Features:

- pressure rating: **300 PSI**
- temperature range: **-40°F to 250°F**
- interchanges with many other manufacturer's designs
- interchanges with MIL Spec. MIL-C-4109F/A-A-59439
- for air service only



Male Pipe Thread

Body Size	Male NPT	Material	Flow Rating at 100 PSI	Part #	Opt Qty
1/4"	1/8"	steel	37 CFM	DCP2101	20
1/4"	1/4"	steel	37 CFM	DCP21	20
1/4"	3/8"	steel	37 CFM	DCP2103	20
3/8"	1/4"	steel	70 CFM	DCP2502	10
3/8"	3/8"	steel	70 CFM	DCP25	10
3/8"	1/2"	steel	70 CFM	DCP2504	10
1/2"	3/8"	steel	150 CFM	DCP1703	10
1/2"	1/2"	steel	150 CFM	DCP17	10
1/2"	3/4"	steel	150 CFM	DCP1706	10
3/4"	1/2"	steel	200 CFM	DCP7104	10
3/4"	3/4"	steel	200 CFM	DCP7106	5
3/4"	1"	steel	200 CFM	DCP7108	5
1/4"	1/8"	brass	37 CFM	DCP2101B	20
1/4"	1/4"	brass	37 CFM	DCP21B	20
1/4"	3/8"	brass	37 CFM	DCP2103B	20
1/4"	1/4"	303 stainless	37 CFM	DCP21S	5
3/8"	3/8"	303 stainless	70 CFM	DCP25S	5
1/2"	1/2"	303 stainless	150 CFM	DCP17S	5



Standard Hose Barb

Body Size	Hose ID	Material	Flow Rating at 100 PSI	Part #	Opt Qty
1/4"	1/4"	steel	37 CFM	DCP2142	20
1/4"	5/16"	steel	37 CFM	DCP2143	20
1/4"	3/8"	steel	37 CFM	DCP2144	20
3/8"	1/4"	steel	70 CFM	DCP2542	10
3/8"	3/8"	steel	70 CFM	DCP2544	10
3/8"	1/2"	steel	70 CFM	DCP2545	10
1/2"	3/8"	steel	150 CFM	DCP1744	10
1/2"	1/2"	steel	150 CFM	DCP1745	10
1/2"	3/4"	steel	150 CFM	DCP1746	10
3/4"	1/2"	steel	200 CFM	DCP7145	5
3/4"	3/4"	steel	200 CFM	DCP7146	5
3/4"	1"	steel	200 CFM	DCP7148	5
1/4"	1/4"	brass	37 CFM	DCP2142B	20
1/4"	3/8"	brass	37 CFM	DCP2144B	20
1/4"	1/4"	303 stainless	37 CFM	DCP2142S	5
3/8"	3/8"	303 stainless	70 CFM	DCP2544S	5
1/2"	1/2"	303 stainless	150 CFM	DCP1745S	5



DCP7145

Push-On Hose Barb

Body Size	Hose ID	Material	Flow Rating at 100 PSI	Part #	Opt Qty
1/4"	1/4"	steel	37 CFM	DCP2142L	25
1/4"	3/8"	steel	37 CFM	DCP2144L	25
3/8"	1/4"	steel	70 CFM	DCP2542L	25
3/8"	3/8"	steel	70 CFM	DCP2544L	25



Air Chief Industrial Interchange Quick-Connect Plugs

Features:

- pressure rating: **300 PSI**
- temperature range: **-40°F to 250°F**
- interchanges with many other manufacturer's designs
- interchanges with MIL Spec. MIL-C-4109F/A-A-59439
- for air service only



Female Pipe Thread

Body Size	Female NPT	Material	Flow Rating at 100 PSI	Part #	Opt Qty
1/4"	1/8"	steel	37 CFM	DCP2021	20
1/4"	1/4"	steel	37 CFM	DCP20	20
1/4"	3/8"	steel	37 CFM	DCP2023	20
3/8"	1/4"	steel	70 CFM	DCP2622	10
3/8"	3/8"	steel	70 CFM	DCP26	10
3/8"	1/2"	steel	70 CFM	DCP2624	10
1/2"	3/8"	steel	150 CFM	DCP1823	10
1/2"	1/2"	steel	150 CFM	DCP18	10
1/2"	3/4"	steel	150 CFM	DCP1826	10
3/4"	1/2"	steel	200 CFM	DCP7024	10
3/4"	3/4"	steel	200 CFM	DCP7026	5
3/4"	1"	steel	200 CFM	DCP7028	5
1/4"	1/4"	brass	37 CFM	DCP20B	20
1/4"	3/8"	brass	37 CFM	DCP2023B	20
1/4"	1/4"	303 stainless	37 CFM	DCP20S	5
3/8"	3/8"	303 stainless	70 CFM	DCP26S	5
1/2"	1/2"	303 stainless	150 CFM	DCP18S	5

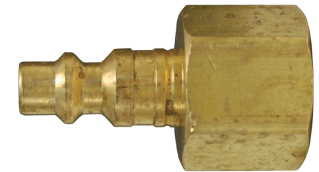

Air Chief Lincoln Interchange Series Quick-Connect Plugs

Features:

- interchangeable with the Lincoln Interchange long stem series
- pressure rating: **300 PSI** at ambient temperature (70°F)

Female Pipe Thread

Body Size	Female NPT	Material	Flow Rating at 100 PSI	Part #	Pkg Qty
1/4"	1/4"	steel	37 CFM	DCP28	10



Male Pipe Thread

Body Size	Male NPT	Material	Flow Rating at 100 PSI	Part #	Pkg Qty
1/4"	1/4"	steel	37 CFM	DCP27	10



Air Chief Lincoln Interchange Series Quick-Connect Couplers

Features:

- interchangeable with the Lincoln Interchange long stem series
- couplers shut-off when disconnected
- pressure rating: **300 PSI**

semi-automatic - pull sleeve to connect

Female Pipe Thread

Body Size	Female NPT	Material	Flow Rating at 100 PSI	Part #	Pkg Qty
1/4"	1/4"	brass	37 CFM	DC28	10

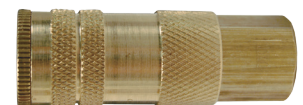

Male Pipe Thread

Body Size	Male NPT	Material	Flow Rating at 100 PSI	Part #	Pkg Qty
1/4"	1/4"	brass	37 CFM	DC27	10

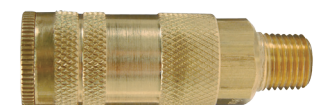

Air Chief ARO Speed Quick-Connect Plugs

Features:

- pressure rating: **300 PSI** at ambient temperature (70°F)
- interchanges with ARO 210 and 310 designs

Female Pipe Thread



Body Size	Female NPT	Material	Flow Rating at 100 PSI	Part #	Opt Qty
1/4"	1/4"	steel	37 CFM	DCP38	10
1/4"	3/8"	steel	37 CFM	DCP3823	10
3/8"	3/8"	steel	70 CFM	DCP36	25

Male Pipe Thread



Body Size	Male NPT	Material	Flow Rating at 100 PSI	Part #	Opt Qty
1/4"	1/4"	steel	37 CFM	DCP37	10
1/4"	3/8"	steel	37 CFM	DCP3703	10
3/8"	3/8"	steel	70 CFM	DCP35	25

Standard Hose Barb



Body Size	Hose ID	Material	Flow Rating at 100 PSI	Part #	Opt Qty
1/4"	1/4"	steel	37 CFM	DCP3742	10
1/4"	3/8"	steel	37 CFM	DCP3744	25

Push-On Hose Barb



Body Size	Hose ID	Material	Flow Rating at 100 PSI	Part #	Opt Qty
1/4"	1/4"	steel	37 CFM	DCP3742L	25
1/4"	3/8"	steel	37 CFM	DCP3744L	25

Air Chief ARO Speed Quick-Connect Couplers

Features:

- pressure rating: **300 PSI** at ambient temperature (70°F)
- interchange with ARO 210 and 310 designs
- couplers shut-off when disconnected
semi-automatic - pull sleeve to connect

Female Pipe Thread

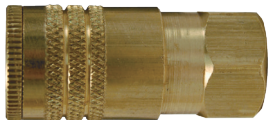

Body Size	Female NPT	Material	Flow Rating at 100 PSI	Part #	Opt Qty
1/4"	1/4"	brass	37 CFM	DC38	10
1/4"	3/8"	brass	37 CFM	DC3823	10
3/8"	3/8"	steel	70 CFM	DC36	25

Male Pipe Thread

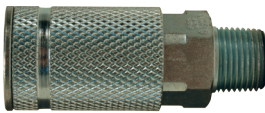

Body Size	Male NPT	Material	Flow Rating at 100 PSI	Part #	Opt Qty
1/4"	1/4"	brass	37 CFM	DC37	10
1/4"	3/8"	brass	37 CFM	DC3703	10
3/8"	3/8"	steel	70 CFM	DC35	25

Standard Hose Barb



Body Size	Hose ID	Material	Flow Rating at 100 PSI	Part #	Opt Qty
1/4"	1/4"	steel	37 CFM	DC3842	10
1/4"	3/8"	steel	37 CFM	DC3844	25

Push-On Hose Barb



Body Size	Hose ID	Material	Flow Rating at 100 PSI	Part #	Opt Qty
1/4"	1/4"	brass	37 CFM	DC3842L	25
1/4"	3/8"	brass	37 CFM	DC3844L	25

Air Chief A Series Quick-Connect Plugs

Application:

- for use in compressed air service where the convenience of one hand operation and a compact profile is desired

Features:

- maximum operating pressure: **500 PSI** at ambient temperature (70°F)
- machined from solid brass bar stock
- stainless steel balls and springs maximize corrosion resistance

Female Pipe Thread

Body Size	Female NPT	Material	Flow Rating at 100 PSI	Part #	Opt Qty
1/8"	1/8"	brass	7 CFM	A1F1-B	20
1/4"	1/4"	brass	25 CFM	A2F2-B	20



Male Pipe Thread

Body Size	Male NPT	Material	Flow Rating at 100 PSI	Part #	Opt Qty
1/8"	1/8"	brass	7 CFM	A1M1-B	20
1/4"	1/4"	brass	25 CFM	A2M2-B	20



Hose Barb

Body Size	Hose ID	Material	Flow Rating at 100 PSI	Part #	Opt Qty
1/8"	1/8"	brass	7 CFM	A1S1-B	20



Air Chief A Series Quick-Connect Couplers

automatic - push to connect

Female Pipe Thread

Body Size	Female NPT	Material	Flow Rating at 100 PSI	Part #	Opt Qty
1/8"	1/8"	brass	7 CFM	1AF1-B	20
1/4"	1/4"	brass	25 CFM	2AF2-B	20

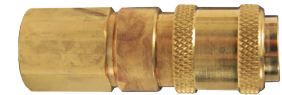

Male Pipe Thread

Body Size	Male NPT	Material	Flow Rating at 100 PSI	Part #	Opt Qty
1/8"	1/8"	brass	7 CFM	1AM1-B	20
1/4"	1/4"	brass	25 CFM	2AM2-B	20



Hose Barb

Body Size	Hose ID	Material	Flow Rating at 100 PSI	Part #	Opt Qty
1/8"	1/8"	brass	7 CFM	1AS1-B	20
1/4"	1/4"	brass	25 CFM	2AS2-B	20



Safety Blow Guns



Safety blow guns have a safety tip which prevents buildup of tip pressure in the event the outlet is obstructed or "dead ended". They comply with the requirements for OSHA 1910.242 (B) and 1910.95 when used on air lines of 150 PSI or less.

Features:

- design comfortably fits contour of the hand minimizing user fatigue
- ergonomic large lever with black vinyl grip allows for easy air flow activation
- ¼" female NPT inlet

Air Chief



The air chief safety blow gun is designed to conform to OSHA Standard 1910.242 (B) permitting a maximum of 30 PSI outlet pressure when dead ended based on a maximum of 150 PSI inlet pressure as well as OSHA Standard 1910.95 regulating occupational noise level exposure. *Safety glasses or shield must be worn when using any blow gun.*

Features:

- recessed internal slotted screw allows easy access to valve assembly for repairs or replacement
- chrome plated zinc die cast body, nickel plated steel lever, vinyl thumb grip, stainless steel spring, brass valve, Buna-N seals and nickel plated brass tip combine for superior corrosion resistance



Part #

D204-30

Premium



The premium safety blow gun is designed to conform to OSHA Standard 1910.242 (B) permitting a maximum of 30 PSI outlet pressure when dead ended based on a maximum of 150 PSI inlet pressure as well as OSHA Standard 1910.95 regulating occupational noise level exposure. *Safety glasses or shield must be worn when using any blow gun.*

Feature:

- zinc die cast body with a black powder coat finish, nickel plated steel lever, vinyl thumb grip, stainless steel spring, brass valve, Buna-N seals and nickel plated brass tip



Part #

D204-30P

Safety Air Booster



The multiple holes in the safety booster tip of the safety air booster gun create a venturi effect that increases air flow (working capacity) while still remaining compliant with OSHA Standard 1910.242 (B). *Safety glasses or shield must be worn when using any blow gun.*

Feature:

- chrome plated zinc die cast body, nickel plated steel lever, vinyl thumb grip, stainless steel spring, brass valve, Buna-N seals and nickel plated brass tip provide superior corrosion resistance



Part #

D204-30SB

Non-Safety Blow Guns



Non-Safety blow guns **do not** have a safety by-pass to prevent buildup of tip pressure in the event of tip blockage. They may be used for cleaning purposes only if the air supply (inlet pressure) has been reduced to 30 PSI or less.

Features:

- designed to comfortably fit the contour of the hand, minimizing user fatigue
- ergonomic large lever with vinyl grip allows for easy air flow activation
- ¼" female NPT inlet

Brass Tip



The ventless, nickel-plated tip provides the most economical means of achieving a concentrated stream of air for many blow-off applications. All other components and design features are the same as our Air Chief safety blow gun (D204-30). *Must be used on air lines having a maximum regulated pressure of 30 PSI in order to comply with OSHA Standard 1910.242 (B). Safety glasses or shield must be worn when using any blow gun.*

Feature:

- chrome plated zinc die cast body, nickel plated steel lever, vinyl thumb grip, stainless steel spring, brass valve, Buna-N seals and ventless, nickel plated brass tip provide superior corrosion resistance



Part #

D605

Rubber Tip



The rubber tip will not scratch or mar delicate surfaces. The conical, rubber tip can also be used to create a seal between the blow gun and fluid lines (or any other opening). Base of the tip is nickel-plated brass for additional corrosion resistance. *Must be used on air lines having a maximum regulated pressure of 30 PSI in order to comply with OSHA Standard 1910.242 (B). Safety glasses or shield must be worn when using any blow gun.*

Feature:

- chrome plated zinc die cast body, nickel plated steel lever, vinyl thumb grip, stainless steel spring, brass valve, Buna-N seals and rubber tip with a nickel plated brass base provide superior corrosion resistance



Part #

D201

Pistol Grip Safety Blow Gun

Features:

- conforms to US Department of Labor, OSHA Standard 1910.242 (B) allowing a maximum of 30 PSI outlet pressure at the nozzle when dead-ended
- conforms to US Department of Labor, OSHA Standard 1910.95 regulating noise level exposure
- conforms to Title 41, Walsh-Healy Rules and Regulations P50-204.8, Safety and Health Standards
- contoured pistol-grip for safe, comfortable handling, even with greasy hands
- convenient hang-up hook
- ¼" female NPT inlet
- *Safety glasses or shield must be worn when using any blow gun.*



Part #

PG700

Extended Nozzle Pistol Grip Safety Blow Gun



Features:

- conforms to US Dept. of Labor, OSHA Standard 1910.242 (B) allowing a maximum of 30 PSI outlet pressure at the nozzle when dead-ended
- conforms to US Dept. of Labor, OSHA Standard 1910.95 regulating noise level exposure
- conforms to Title 41, Walsh-Healy Rules and Regulations P50-204.8 Safety and Health Standards
- slender 4" extended nozzle allows access to hard to reach places and holes as small as .200"
- variable output trigger enables user to control air flow
- hook design near trigger provides finger protection as well as easy storage
- lightweight to help minimize user fatigue.
- side holes allow air to escape if nozzle tip is dead-ended, thus preventing back pressure buildup
- pressure rating: **150 PSI**
- 1/4" female NPT inlet
- safety glasses or shield must be worn when using any blow gun



Part #

ENBG1

Blow Gun Extensions



Features:

- supplied with 1/8" male NPT connections
- allow easier access to blow-off applications in high or hard to reach places
- can be used with all Dixon Air Chief lever operated blow guns as well as most blow guns from other manufacturers
- brass base with a rugged steel extension tube, all nickel plated

Size Extension	Part #
6"	BGE6
10"	BGE10
12"	BGE12
18"	BGE18
24"	BGE24

Blow Gun Tips

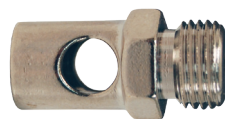

Features:

- safety tip
- 1/8" male NPT connection
- can be used with all Dixon Air Chief lever operated blow guns as well as most blow guns from other manufacturers

Nickel Plated Brass

Part #

SST10



Features:

- 1/8" male NPT connection
- can be used with all Dixon Air Chief lever operated blow guns as well as most blow guns from other manufacturers

Rubber Coated Nickel Plated Brass

Part #

D201RT

Coil-Chief Self-Storing Air Hose

fittings included

Feature:

- supplied with swivel on one end

Hose ID	Length	Male NPT	Working Pressure at 70°F	Nylon Part #
1/4"	12'	1/4"	185	CC1412
1/4"	25'	1/4"	185	CC1425
1/4"	50'	1/4"	185	CC1450
3/8"	25'	3/8"	165	CC3825
3/8"	50'	3/8"	165	CC3850
1/2"	25'	1/2"	170	CC1225
1/2"	50'	1/2"	170	CC1250



bulk hose - no fittings

Feature:

- needs assembly kits for ends

Hose ID	Length	Part #
1/4"	100'	CC14100B
3/8"	100'	CC38100B
1/2"	100'	CC12100B



Assembly Kits

Feature:

- kits include fittings, nut, insert, ferrule and spring guard

Size	Fitting Type	Part #
1/4"	rigid male	RK090
1/4"	swivel male	RK092
3/8"	rigid male	RK110
3/8"	swivel male	RK112
1/2"	rigid male	RK118
1/2"	swivel male	RK119



RK110 assembly kit

Polyurethane Self-Storing Air Hose

fittings included

Features:

- extremely flexible - resists kinking
- impervious to abrasions, heat and oil
- superior elasticity and coil memory
- blue
- both ends swivel
- working pressure: **125 PSI at 70°F**

Hose ID	Length	Male NPT	Part #
1/4"	10'	1/4"	PU1410
1/4"	15'	1/4"	PU1415
1/4"	25'	1/4"	PU1425
3/8"	15'	3/8"	PU3815
3/8"	20'	3/8"	PU3820
3/8"	25'	3/8"	PU3825
3/8"	50'	3/8"	PU3850
1/2"	15'	1/2"	PU1215



Repair Kits

Tubing Size		Size	Type	Part #
ID	OD			
1/4"	3/8"	1/4"	swivel male	PSM0404
3/8"	9/16"	1/4"	swivel male	PSM0604



Conical Mufflers

Application:

- threads into the exhaust ports of air tool, valves, cylinders and other pneumatic equipment

Features:

- an economical way to reduce noise levels below 90 dBA to conform with OSHA standards
- 40 micron bronze filter element
- element is bonded directly to the fitting and *is not replaceable*
- maximum operating pressure: **300 PSI**
- temperature range: **35°F to 300°F**



NPT Thread	Overall Length	Nickel Plated Steel Part #
1/8"	1-1/8"	CMF18
1/4"	1-3/8"	CMF28
3/8"	1-1/2"	CMF38
1/2"	1-7/8"	CMF48
3/4"	2-1/8"	CMF68
1"	2-7/8"	CMF88

Breather Vents

Applications:

- commonly used on single acting cylinders or valves to prevent dirt and foreign particles from entering ports open to the atmosphere additionally
- provide vacuum relief or pressure equalization on gear boxes, oil tanks or reservoirs

Features:

- standard pipe thread connections for quick assembly and removal for cleaning
- nickel plated steel insert with a bronze filter
- 40 micron filter element
- maximum operating pressure: **150 PSI**
- temperature range: **35°F to 300°F**



NPT Thread	Overall Length	Nickel Plated Steel Part #
1/8"	7/16"	ASP-1BV
1/4"	5/8"	ASP-2BV
3/8"	3/4"	ASP-3BV
1/2"	7/8"	ASP-4BV
3/4"	1"	ASP-6BV
1"	1-5/16"	ASP-8BV

Mini In-Line Lubricators

Features:

- can be refilled under line pressure
- oil capacity: 1/4 fluid ounce
- flow rating: 22 SCFM at 100 PSIG
- maximum operating pressure: **200 PSIG**
- maximum temperature: **175°F**

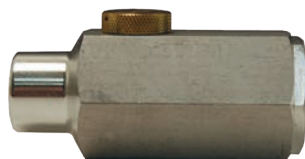

Female NPT Inlet	Outlet	Aluminum Part #
1/4"	1/4" female NPT	ML200
1/4"	1/4" male NPT	ML200M
3/8"	3/8" male NPT	ML300M

Mini In-Line Filter

Features:

- either port may be used as an inlet port
- filter element rated at 5 microns
- flow rating: 17 SCFM inlet pressure at 100 PSIG
- maximum operating pressure: **200 PSIG**
- maximum temperature: **175°F**



Female NPT	Male NPT	Aluminum Part #
1/4"	1/4"	MF200
Description		Part #
replacement element		FRP-95-199

Safety Pop-Off Valves

Heavy Duty, High Capacity Safety Pop-Off Valves

Features:

- designed to protect un-fired pressure vessels from over-pressure
- all brass construction with chrome steel ball on a precision machined brass seat
- equipped with a pull ring for manual testing
- ASME Code, National Board Certified
- maximum temperature: **400°F (204°C)**

½" male NPT

Preset Pressure PSI	SCFM	Brass Part #
30	73	SV30HD
100	211	SV100HD
125	254	SV125HD
150	303	SV150HD
175	346	SV175HD
200	395	SV200HD



Standard Safety Pop-Off Valves

Features:

- designed to protect un-fired pressure vessels from over-pressure
- brass valves are supplied with a stainless steel ball
- stainless valves are all stainless construction with a soft seat
- ASME Code, National Board Certified
- minimum temperature: **-40°F**
- maximum temperature: **400°F (204°C)**
- for use with compressors
- valves reset themselves

¼" male NPT

Preset Pressure PSI	Brass Part #	SCFM	Stainless Steel Part #	SCFM
30	SV30	35	SV30SS	35
100	SV100	120	SV100SS	92
125	SV125	109	SV125SS	112
150	SV150	155	SV150SS	132
175	SV175	149	SV175SS	153
200	SV200	200	SV200SS	173



Soft Seat Safety Pop-Off Valves

Application:

- for compressed air service applications

Features:

- designed for Original Equipment Manufacturers utilizing ASME Code un-fired pressure vessels in their finished product
- constructed of precision machined brass bar stock with a silicone disc seating on brass
- ASME Code, National Board Certified
- maximum temperature: is **400°F (204°C)**

¼" male NPT

Preset Pressure PSI	SCFM	Brass Part #
100	51	KSV10-100
125	62	KSV10-125
150	73	KSV10-150
175	84	KSV10-175



Brass Needle Valves

Features:

- metal-to-metal seats allow positive sealing and flow adjustment
- designed for air and water applications
- maximum working pressure: **150 PSI** at ambient temperature (70°F)

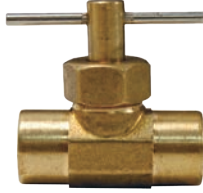

Female NPT	Female NPT	Brass Part #
1/8"	1/8"	NV2F
1/4"	1/4"	NV4F

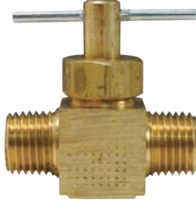

Male NPT	Male NPT	Brass Part #
1/4"	1/4"	NV4M

Bar Manifolds

Features:

- can be mounted on a wall or work bench, safely distributing four hose lines to a work area
- maximum operating pressure: **300 PSI** at ambient temperature (70°F)

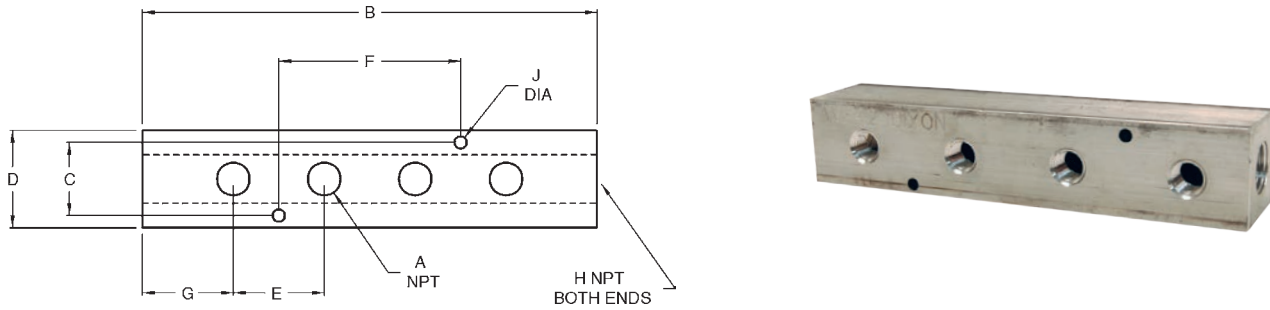

Dimensions

Aluminum Part #	A	B	C	D	E	F	G	H	J
AMF32	1/4"	7 5/8"	7/8"	1 1/4"	1 7/8"	3 3/4"	1"	3/8"	.20"
AMF42	1/4"	7 5/8"	1 1/8"	1 1/2"	1 7/8"	3 3/4"	1"	1/2"	.20"
AMF43	3/8"	8"	1 1/8"	1 1/2"	2"	4"	1"	1/2"	.20"

3 in 1 Manifolds

Features:

- supplies 3 air operated tools from a single hose permitting use of air by more than one mechanic
- can be mounted to a pipe at workbench or overhead
- different tools in the shop use different styles of couplers, mount 3 different style couplers on one manifold

NPT Inlet (1)	NPT Outlets (3)	Aluminum Part #
1/4"	1/4"	D3404
3/8"	1/4"	D3406
1/2"	1/4"	D3408



Flat Hex Manifolds

Feature:

- designed to lay flat on the floor, safely distributing three hose lines to the work area

NPT Inlet (1)	NPT Outlets (3)	Brass Part #
1/4"	1/4"	3122
3/8"	1/4"	3132
3/8"	3/8"	3133

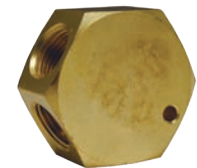

In-Line Swivels

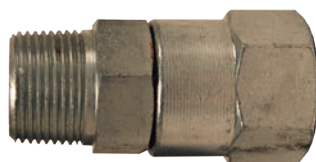

Features:

- for air service only
- rated to **250 PSI** at ambient temperature (70°F), minimum **35 PSI**
- heavy-duty, free turning steel swivel

Male NPT	Female NPT	Steel Part #
3/8"	1/2"	SV17
1/2"	1/2"	SV20
3/4"	3/4"	SV26

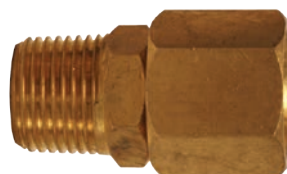

Features:

- for air service only
- rated to **150 PSI** at ambient temperature (70°F)

Male NPT	Female NPT	Brass Part #
1/4"	1/4"	D344R
3/8"	3/8"	D366R

Air Tool Swivels



Features:

- swivels at two locations so air hose can drop directly to the floor
- rated to **150 PSI** at ambient temperature (70°F)
- do not use with percussion tools

Size	Aluminum Part #
1/4"	D344U ¹
3/8"	D346U
1/2"	D348U

¹ D344U is a non-marring composite.

Safety Vented Ball Valves

Applications:

- for air service only
- vent downstream air in accordance with OSHA regulation 1910.147 for pneumatic systems

Features:

- pressure rating: **600 PSI**
- brass valve
- chromium plated ball
- RTFE seats and stuffing box ring
- blow-out proof stem design
- adjustable packing gland



female NPT x female NPT

Size	Port	Brass Part #
1/4"	full	BBV25LV
3/8"	full	BBV38LV
1/2"	full	BBV50LV
3/4"	standard	BBV75LV
1"	standard	BBV100LV
1 1/4"	standard	BBV125LV
1 1/2"	standard	BBV150LV
2"	standard	BBV200LV

Brass Flow Control Valves

Series F

Features:

- provides precision flow control and full shutoff in one flow direction, automatically allows unrestricted flow in the opposite direction
- two-step needle for fine adjustments at low flow with first 3 turns of the adjusting knob, next 3 turns give full-open needle position and conventional throttling control
- when flow is reversed the heavy-duty poppet/retainer permits full flow return capacity
- color coded scale simplifies flow setting, resetting, adjusting and return to an original flow
- a set screw locks the valve on any desired setting
- maximum operating pressure: **2000 PSI** at ambient temperature (70°F) for sizes 1/8" - 3/4", **500 PSI** at ambient temperature (70°F) for 1"
- also available in steel



Female NPT	Brass Part #
1/8"	BFC200
1/4"	BFC400
3/8"	BFC600
1/2"	BFC800
3/4"	BFC1200
1"	BFC1600

Series PF

Features:

- ball type check meters flow of air in one direction and allows free flow in the reverse direction
- used to control actuator speed by acting as a restriction
- maximum operating pressure: **2000 PSI** at ambient temperature (70°F)
- cracking pressure: **5 PSI**
- also available in steel



Female NPT	Brass Part #
1/8"	BPF200
1/4"	BPF400
3/8"	BPF600
1/2"	BPF800

Series N

Features:

- for use as speed control on pneumatic systems where a reverse flow check valve is not needed
- provides excellent control and reliable shutoff in a very small envelope
- color coded scale simplifies setting, resetting, adjusting and quick return to a previous speed setting
- maximum operating pressure: **2000 PSI** at ambient temperature (70°F) for sizes 1/8" - 3/4", **500 PSI** at ambient temperature (70°F) for 1"
- also available in steel



Female NPT	Brass Part #
1/8"	BN200
1/4"	BN400
3/8"	BN600
1/2"	BN800
3/4"	BN1200
1"	BN1600

Brass Check Valves - Series C

Features:

- provides free flow in one direction and dependable shutoff in the opposite direction
- maximum operating pressure: **2000 PSI** at ambient temperature (70°F)
- cracking pressure: **5 PSI**
- also available in steel



Female NPT	Free Flow GPM	Brass Part #
1/8"	3	BCV200
1/4"	5	BCV400
3/8"	8	BCV600
1/2"	15	BCV800

Dixon, founded in 1916, is a premier manufacturer and supplier of hose couplings, valves, dry-disconnects, swivels, and other fluid transfer and control products. The company's global reach includes a wide range of products for numerous industries including petroleum exploration, refining, transportation, chemical processing, food & beverage, steel, fire protection, construction, mining and manufacturing. Dixon's strategic objective is to create solutions that make products safer, leak-free, longer lasting, and always available.

dixonvalve.com • Customer Service: 877.963.4966

Dixon Valve

800 High Street, Chestertown, MD 21620

Fax: 800.283.4966



YouTube



Dixon
Customer Service