

DATE
MAY 28, 2009
CATALOG # DTP0034G

OUTLINE DIMENSIONS
3-PHASE INDUCTION MOTOR

MOTOR TYPE:
ASGH-SGR
FRAME NO. 182T

Pole	HP	kW	Hz	VOLT	Syn.Speed r/min(rpm)
4	3	2.24	60	230/460	1800

Ins	Rating	Dimension in	Approx Weight	Bearings
F	CONT.	inches	60 lbs.	DE: 6206ZZC3NDE: 6205ZZC3

Open Protected Drip-Proof Squirrel Cage Rotor.

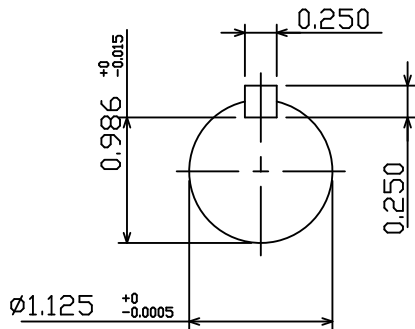
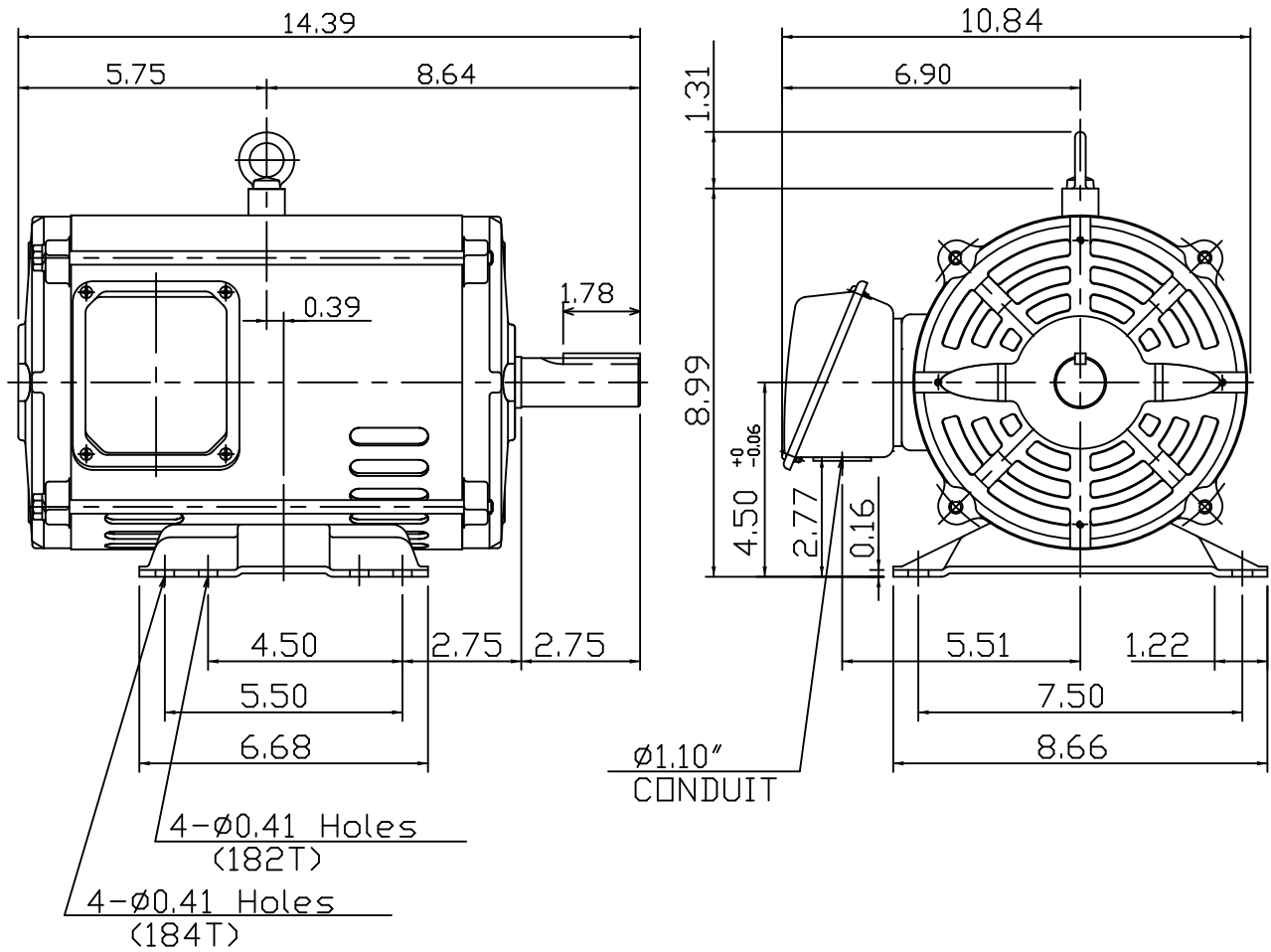

NOTE:
1.AEGIS Grounding ring installed on Drive-end.



DWN.	J.H.LIANG	04-28-08
CHKD.	H.C.YAN	05-05-08
APPD.	M.C.TSAI	05-05-08



DWG NO.
31049R170010