

BALDOR® • RELIANCE 

Product Information Packet

EM2539T-BG

40HP, 1770RPM, 3PH, 60HZ, 324T, 4064M, OPSB, F1

Part Detail							
Revision:	H	Status:	PRD/A	Change #:		Proprietary:	No
Type:	AC	Elec. Spec:	40WG166	CD Diagram:	CD0005	Mfg Plant:	
Mech. Spec:	40E331	Layout:	40LYE331	Poles:	04	Created Date:	10-08-2013
Base:	RG	Eff. Date:	05-16-2018	Leads:	9#8		

Specs			
Catalog Number:	EM2539T-BG	Insulation Class:	H
Enclosure:	OPSB	Inverter Code:	Inverter Ready
Frame:	324T	KVA Code:	H
Frame Material:	Steel	Lifting Lugs:	Standard Lifting Lugs
Output @ Frequency:	40.000 HP @ 60 HZ	Locked Bearing Indicator:	No Locked Bearing
Synchronous Speed @ Frequency:	1800 RPM @ 60 HZ	Motor Lead Quantity/Wire Size:	9 @ 8 AWG
Voltage @ Frequency:	460.0 V @ 60 HZ	Motor Lead Exit:	Ko Box
	230.0 V @ 60 HZ	Motor Lead Termination:	Flying Leads
Agency Approvals:	CSA	Motor Type:	4064M
	CSA EEV	Mounting Arrangement:	F1
	UR	Power Factor:	82
Auxillary Box:	No Auxillary Box	Product Family:	General Purpose
Auxillary Box Lead Termination:	None	Pulley End Bearing Type:	Ball
Base Indicator:	Rigid	Pulley Face Code:	Standard
Bearing Grease Type:	Polyrex EM (-20F +300F)	Pulley Shaft Indicator:	Standard
Blower:	None	Rodent Screen:	None
Current @ Voltage:	99.000 A @ 208.0 V	Shaft Extension Location:	Pulley End
	98.000 A @ 230.0 V	Shaft Ground Indicator:	Shaft Grounding

	49.000 A @ 460.0 V	Shaft Rotation:	Reversible
Design Code:	A	Shaft Slinger Indicator:	No Slinger
Drip Cover:	No Drip Cover	Speed Code:	Single Speed
Duty Rating:	CONT	Motor Standards:	NEMA
Electrically Isolated Bearing:	Not Electrically Isolated	Starting Method:	Direct on line
Feedback Device:	NO FEEDBACK	Thermal Device - Bearing:	NONE (OLD)
Front Face Code:	Standard	Thermal Device - Winding:	None
Front Shaft Indicator:	None	Vibration Sensor Indicator:	No Vibration Sensor
Heater Indicator:	No Heater	Winding Thermal 1:	None
		Winding Thermal 2:	None

Nameplate NP3554L										
CAT.NO.	EM2539T-BG				P/N				ENCL	OPSB
SPEC.	40E331X166G1		CC	010A	FRAME	324T		SER.NO.		
HP	40		CLASS	H	HZ	60				
RPM	1770		PH	3	DES	A				
VOLTS	230/460			CODE	H		ODE BRG	6309	DE BRG	6312
AMPS	98/49		USABLE AT 208V		99					
RATING	40C AMB-CONT			NEMA-NOM-EFF		94.1		GREASE	POLYREX EM	
PF	82	SER.F.	1.15		VPWM INVERTER READY					
HTR-VOLTS			HTR-AMPS			MAX. SPACE HEATER TEMP.				

Parts List		
Part Number	Description	Quantity
SA270435	SA 40E331X166G1	1.000 EA
RA257070	RA 40E331X166G1	1.000 EA
S/P107-000-004	SUPER-E(284 FR. & UP)-CL PLANT,POLYREX E	1.000 EA
HA6361A01	LIFTING LUG FOR 37, 39 & 40 FRAME ZINC	2.000 EA
HA6017	CAST ADAPTER, 40,42 KOBX	1.000 EA
19XW3118A12	.31-18 X .75 HEX WASHER HEAD TAPTITE II	2.000 EA
HW1001A31	LOCKWASHER 5/16, ZINC PLT.591 OD, .319 I	2.000 EA
WD1000B25	GND LUG, BURNDY L125HP OR T&B L125HP-BB	1.000 EA
19XW3118G08	.31-18X.50,HEX WSHR HD,TAPTITE 2,GREEN	1.000 EA
10CB3001	CONDUIT BOX CAST W/2.500 LEAD HOLE	1.000 EA
19XW3118A12	.31-18 X .75 HEX WASHER HEAD TAPTITE II	4.000 EA
HW1001A31	LOCKWASHER 5/16, ZINC PLT.591 OD, .319 I	4.000 EA
40EP3200A02	STD FREP OPEN 309 BRG	1.000 EA
HW5100A11	W3917-042 WVY WSHR (WB)	1.000 EA
10XN3118K40	5/16-18 X 2.50" HEX HD, GRADE 5	4.000 EA
HW1001A31	LOCKWASHER 5/16, ZINC PLT.591 OD, .319 I	4.000 EA
40EP3201A04	PUEP, MACH - OPEN - FOR 312 BRG W/RET. R	1.000 EA
XY3816A12	3/8-16 FINISHED NUT	8.000 EA
10CB3500SP	CONDUIT BOX LID, CAST	1.000 EA
51XW2520A12	.25-20 X .75, TAPTITE II, HEX WSHR SLTD	4.000 EA
HW2501H33	KEY, 1/2 SQ X 3.875	1.000 EA
LB1115N	LABEL,LIFTING DEVICE (ON ROLLS)	1.000 EA
MN416A01	TAG-INSTAL-MAINT no wire (1200/bx) 5/18	1.000 EA
LB1508	LABEL "SHAFT GROUNDING BRUSH" 1.50 X .81	1.000 EA

Parts List (continued)		
Part Number	Description	Quantity
HA4051A00	PLASTIC CAP FOR GREASE FITTING	1.000 EA
HW4500A03	GREASE FITTING, .125 NPT 1610(ALEMITE) 8	1.000 EA
HW4500A20	1/8NPT SL PIPE PLUG	1.000 EA
MJ1000A02	GREASE, POLYREX EM EXXON (USe 4824-15A)	0.050 LB
HA4051A00	PLASTIC CAP FOR GREASE FITTING	1.000 EA
HW4500A03	GREASE FITTING, .125 NPT 1610(ALEMITE) 8	1.000 EA
HW4500A20	1/8NPT SL PIPE PLUG	1.000 EA
HA3159A08	THRUBOLT- .38-16 X 20.00 LONG STUD	4.000 EA
MG1000Y03	MUNSELL 2.53Y 6.70/ 4.60, GLOSS 20,	0.030 GA
85XU0407S04	4X1/4 U DRIVE PIN STAINLESS	4.000 EA
40AD2002A01	LEXAN BAFFLE 40 FR OPEN	1.000 EA
40AD2002A01	LEXAN BAFFLE 40 FR OPEN	1.000 EA
LC0005E01	CONN.DIA./WARNING LABEL (LC0005/LB1119N)	1.000 EA
NP3554L	SS SUPER-E UL CSA-EEV PREM CC	1.000 EA
40PA1000	PACKAGING GROUP	1.000 EA

AC Induction Motor Performance Data

Record # 35574 - Typical performance - not guaranteed values

Winding: 40WGX166-R003	Type: 4064M	Enclosure: OPSB
-------------------------------	--------------------	------------------------

Nameplate Data				460 V, 60 Hz: High Voltage Connection	
Rated Output (HP)	40			Full Load Torque	119 LB-FT
Volts	230/460			Start Configuration	direct on line
Full Load Amps	98/49			Breakdown Torque	427 LB-FT
R.P.M.	1770			Pull-up Torque	187 LB-FT
Hz	60	Phase	3	Locked-rotor Torque	246 LB-FT
NEMA Design Code	A	KVA Code	H	Starting Current	330 A
Service Factor (S.F.)	1.15			No-load Current	21.1 A
NEMA Nom. Eff.	94.1	Power Factor	82	Line-line Res. @ 25°C	0.16236 Ω
Rating - Duty	40C AMB-CONT			Temp. Rise @ Rated Load	41°C
S.F. Amps				Temp. Rise @ S.F. Load	51°C
				Locked-rotor Power Factor	32
				Rotor inertia	5.09 LB-FT ²

Load Characteristics 460 V, 60 Hz, 40 HP

% of Rated Load	25	50	75	100	125	150	S.F.
Power Factor	43	65	76	82	85	85	84
Efficiency	91.1	94	94.5	94.2	93.6	92.8	93.8
Speed	1792.4	1785	1777.8	1770.2	1762.1	1752.8	1765
Line amperes	24.1	30.7	39.2	48.7	59.3	71.3	55.1

Performance Graph at 460V, 60Hz, 40.0HP Typical performance - Not guaranteed values

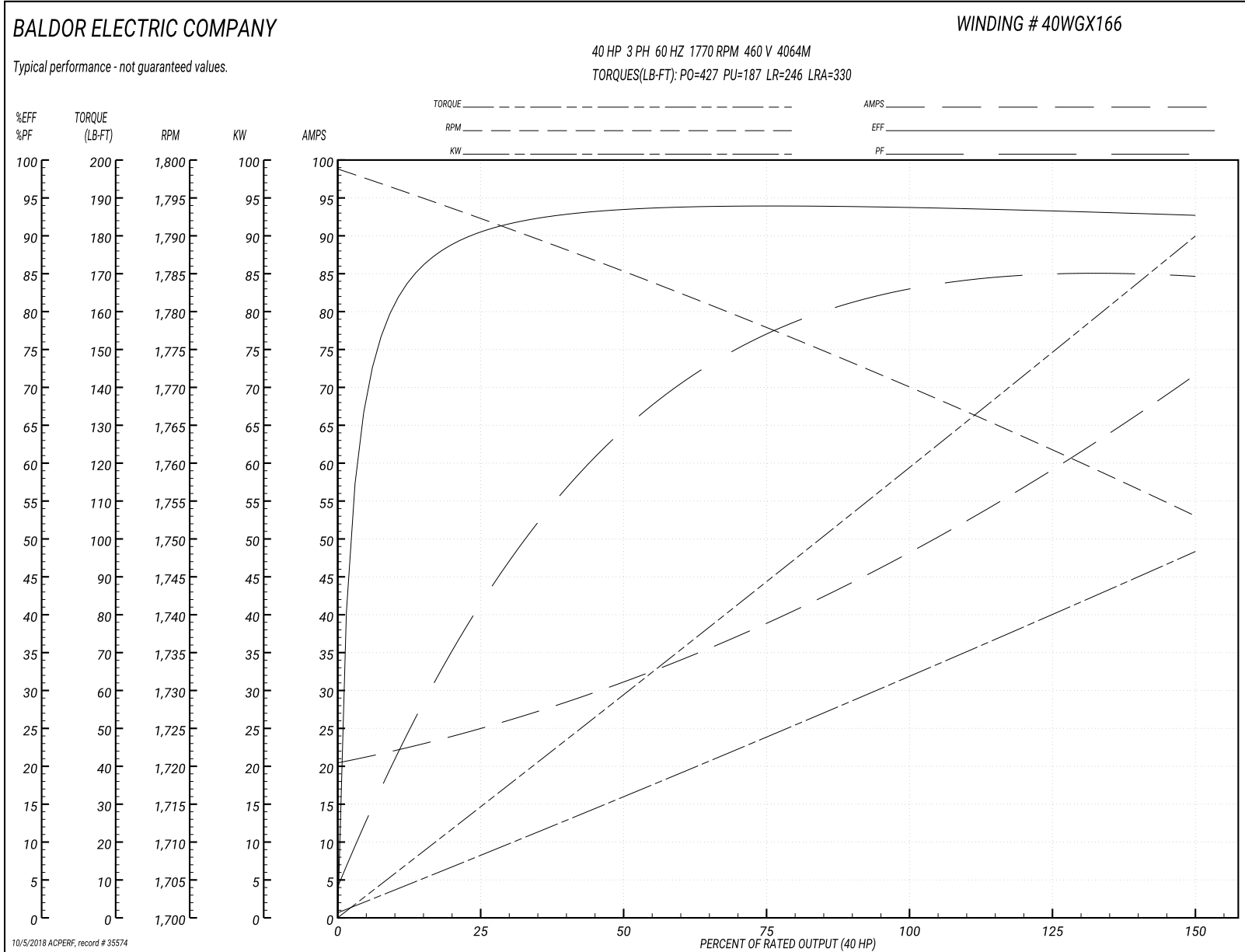

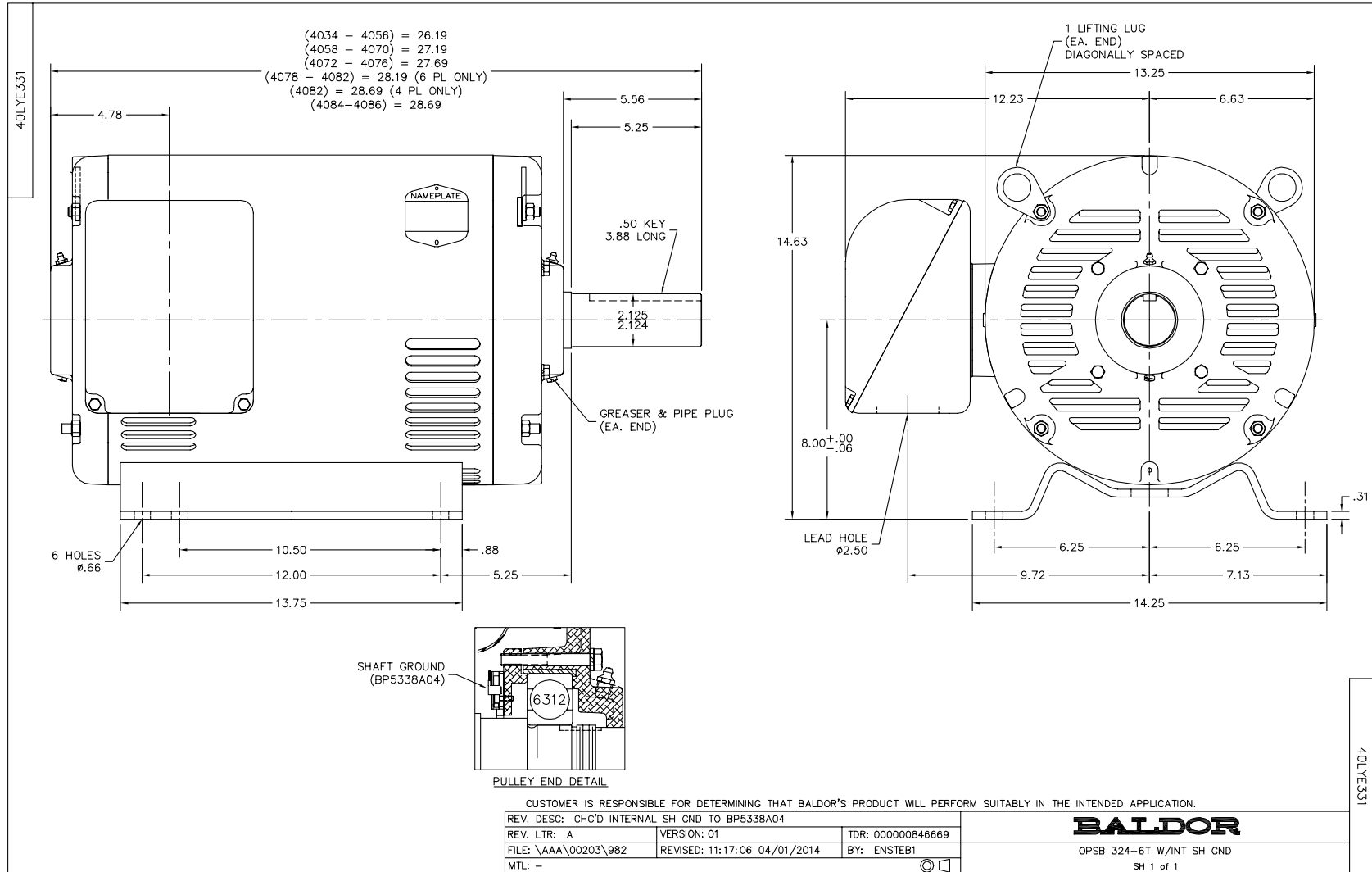

CD0005



LOW VOLTAGE
(2Y)



LINE

HIGH VOLTAGE
(1Y)



LINE

NOTES:

1. INTERCHANGE ANY TWO LINE LEADS TO REVERSE ROTATION.
2. OPTIONAL THERMOSTATS ARE PROVIDED WHEN SPECIFIED.
3. ACTUAL NUMBER OF INTERNAL PARALLEL CIRCUITS MAY BE A MULTIPLE OF THOSE SHOWN ABOVE.
4. LEAD COLORS ARE OPTIONAL. LEADS MUST ALWAYS BE NUMBERED AS SHOWN.

REV. DESC: REVISE TO SHOW OPTIONAL COLORS			
REV. LTR: E	BY: JLP	REVISED: 01/19/99 10:15	TDR: 0171435
900000		FILE: AAA00005140	MDL: -
		MTL: -	

BALDOR ELECTRIC Co.

3PH, DV, 9 LEADS

CD0005