

BALDOR® • RELIANCE 

Product Information Packet

EM3554T-G

1.5HP, 1760RPM, 3PH, 60HZ, 145T, 3526M, TEFC, F

Part Detail							
Revision:	T	Status:	PRD/A	Change #:		Proprietary:	No
Type:	AC	Elec. Spec:	35WGM493	CD Diagram:	CD0005	Mfg Plant:	
Mech. Spec:	35Z063	Layout:	35LYZ063	Poles:	04	Created Date:	12-09-2010
Base:	RG	Eff. Date:	03-14-2018	Leads:	9#18		

Specs			
Catalog Number:	EM3554T-G	Heater Indicator:	No Heater
Enclosure:	TEFC	Insulation Class:	H
Frame:	145T	Inverter Code:	Inverter Ready
Frame Material:	Steel	KVA Code:	L
Output @ Frequency:	1.500 HP @ 60 HZ	Lifting Lugs:	No Lifting Lugs
Synchronous Speed @ Frequency:	1800 RPM @ 60 HZ	Locked Bearing Indicator:	Locked Bearing
Voltage @ Frequency:	460.0 V @ 60 HZ	Motor Lead Quantity/Wire Size:	9 @ 18 AWG
	230.0 V @ 60 HZ	Motor Lead Exit:	Ko Box
XP Class and Group:	None	Motor Lead Termination:	Flying Leads
XP Division:	Not Applicable	Motor Type:	3526M
Agency Approvals:	UR	Mounting Arrangement:	F1
	CSA EEV	Power Factor:	73
	CSA	Product Family:	General Purpose
Auxillary Box:	No Auxillary Box	Pulley End Bearing Type:	Ball
Auxillary Box Lead Termination:	None	Pulley Face Code:	Standard
Base Indicator:	Rigid	Pulley Shaft Indicator:	Standard
Bearing Grease Type:	Polyrex EM (-20F +300F)	Rodent Screen:	None
Blower:	None	Shaft Extension Location:	Pulley End

Current @ Voltage:	2.200 A @ 460.0 V	Shaft Ground Indicator:	Shaft Grounding
	4.400 A @ 230.0 V	Shaft Rotation:	Reversible
	4.500 A @ 208.0 V	Shaft Slinger Indicator:	No Slinger
Design Code:	B	Speed Code:	Single Speed
Drip Cover:	No Drip Cover	Motor Standards:	NEMA
Duty Rating:	CONT	Starting Method:	Direct on line
Electrically Isolated Bearing:	Not Electrically Isolated	Thermal Device - Bearing:	NONE (OLD)
Feedback Device:	NO FEEDBACK	Thermal Device - Winding:	None
Front Face Code:	Standard	Vibration Sensor Indicator:	No Vibration Sensor
Front Shaft Indicator:	None	Winding Thermal 1:	None
		Winding Thermal 2:	None

Nameplate NP3441L										
CAT.NO.	EM3554T-G									
SPEC.	35Z063M493G1									
HP	1.5									
VOLTS	230/460									
AMP	4.4/2.2									
RPM	1760									
FRAME	145T			HZ	60				PH	3
SER.F.	1.15		CODE	L		DES	B		CL	H
NEMA-NOM-EFF	86.5		PF	73						
RATING	40C AMB-CONT									
CC	010A					USABLE AT 208V	4.5			
DE	6205			ODE	6203					
ENCL	TEFC		SN							
VPWM INVERTER READY										
CT6-60H(10:1)VT3-60H(20:1)										

Parts List		
Part Number	Description	Quantity
SA212864	SA 35Z063M493G1	1.000 EA
RA200093	RA 35Z063M493G1	1.000 EA
34FN3002B01	EXTERNAL FAN, PLASTIC, .637/.639 HUB W/	1.000 EA
NS2512A01	INSULATOR, CONDUIT BOX X	1.000 EA
35CB3009	35 CB W/1.09 DIA. LEAD HOLE @ 6:	1.000 EA
36GS1000SP	GASKET-CONDUIT BOX, .06 THICK #SV-330 LE	1.000 EA
51XB1016A07	10-16 X 7/16 HXWSSLD SERTYB	2.000 EA
11XW1032G06	10-32 X .38, TAPTITE II, HEX WSHR SLTD U	1.000 EA
35EP3122A00	MASTER ODE,203 BRG,.683SH,#26 DRN,GRSR,F	1.000 EA
HW4500A01	1641B(ALEMITE)400 UNIV, GREASE FITT	1.000 EA
HW5100A03	WAVY WASHER (W1543-017)	1.000 EA
35EP3123F05	F00 W/LCK BRG	1.000 EA
HW4500A01	1641B(ALEMITE)400 UNIV, GREASE FITT	1.000 EA
51XN1032A20	10-32 X 1 1/4 HX WS SL SR	2.000 EA
XY1032A02	10-32 HEX NUT DIRECTIONAL SERRATION	4.000 EA
51XB1214A16	12-14X1.00 HXWSSLD SERTYB	1.000 EA
35FH4005A84SP	IEC FH W/GRSR, NO DIMPLES PRIMED	1.000 EA
51XW1032A06	10-32 X .38, TAPTITE II, HEX WSHR SLTD S	3.000 EA
35CB4521GX	CONDUIT BOX LID KIT **ORDER INDIV PARTS	1.000 EA
51XW0832A07	8-32 X .44, TAPTITE II, HEX WSHR SLTD SE	4.000 EA
HW2501D13	KEY, 3/16 SQ X 1.375	1.000 EA
HA7000A01	KEY RETAINER 7/8" DIA SHAFT	1.000 EA
85XU0407S04	4X1/4 U DRIVE PIN STAINLESS	2.000 EA
LB1459	AEGIS SGR LABEL "AEGISLBL-100"	1.000 EA

Parts List (continued)		
Part Number	Description	Quantity
MJ1000A02	GREASE, POLYREX EM EXXON (USe 4824-15A)	0.050 LB
MG1000Y03	MUNSELL 2.53Y 6.70/ 4.60, GLOSS 20,	0.017 GA
HA3100A18	THRUBOLT 10-32 X 9.250	4.000 EA
LC0005E01	CONN.DIA./WARNING LABEL (LC0005/LB1119N)	1.000 EA
NP3441L	ALUM SUPER-E VPWM INVERTER READY UL	1.000 EA
36PA1000	PKG GRP, PRINT PK1016A06	1.000 EA
MN416A01	TAG-INSTAL-MAINT no wire (1200/bx) 5/18	1.000 EA
LB1350	BAR CODE LABEL FOR YORK	1.000 EA
FE-0000001	ZRTG FE ASSEMBLY	1.000 EA

AC Induction Motor Performance Data

Record # 53325 - Typical performance - not guaranteed values

Winding: 35WGM493-R079	Type: 3526M	Enclosure: TEFC
-------------------------------	--------------------	------------------------

Nameplate Data				460 V, 60 Hz: High Voltage Connection	
Rated Output (HP)	1.5			Full Load Torque	4.47 LB-FT
Volts	230/460			Start Configuration	direct on line
Full Load Amps	4.4/2.2			Breakdown Torque	19.2 LB-FT
R.P.M.	1760			Pull-up Torque	9.4 LB-FT
Hz	60	Phase	3	Locked-rotor Torque	13.4 LB-FT
NEMA Design Code	B	KVA Code	L	Starting Current	18.3 A
Service Factor (S.F.)	1.15			No-load Current	1.37 A
NEMA Nom. Eff.	86.5	Power Factor	73	Line-line Res. @ 25°C	10.7 Ω
Rating - Duty	40C AMB-CONT			Temp. Rise @ Rated Load	44°C
S.F. Amps				Temp. Rise @ S.F. Load	52°C
				Locked-rotor Power Factor	52
				Rotor inertia	0.154 LB-FT ²

Load Characteristics 460 V, 60 Hz, 1.5 HP

% of Rated Load	25	50	75	100	125	150	S.F.
Power Factor	31	51	65	73	79	83	77
Efficiency	76.2	84.5	86.9	87.2	86.5	85.3	86.8
Speed	1791	1781	1771	1760	1748	1735	1753
Line amperes	1.44	1.61	1.86	2.19	2.58	2.98	2.42

Performance Graph at 460V, 60Hz, 1.5HP Typical performance - Not guaranteed values

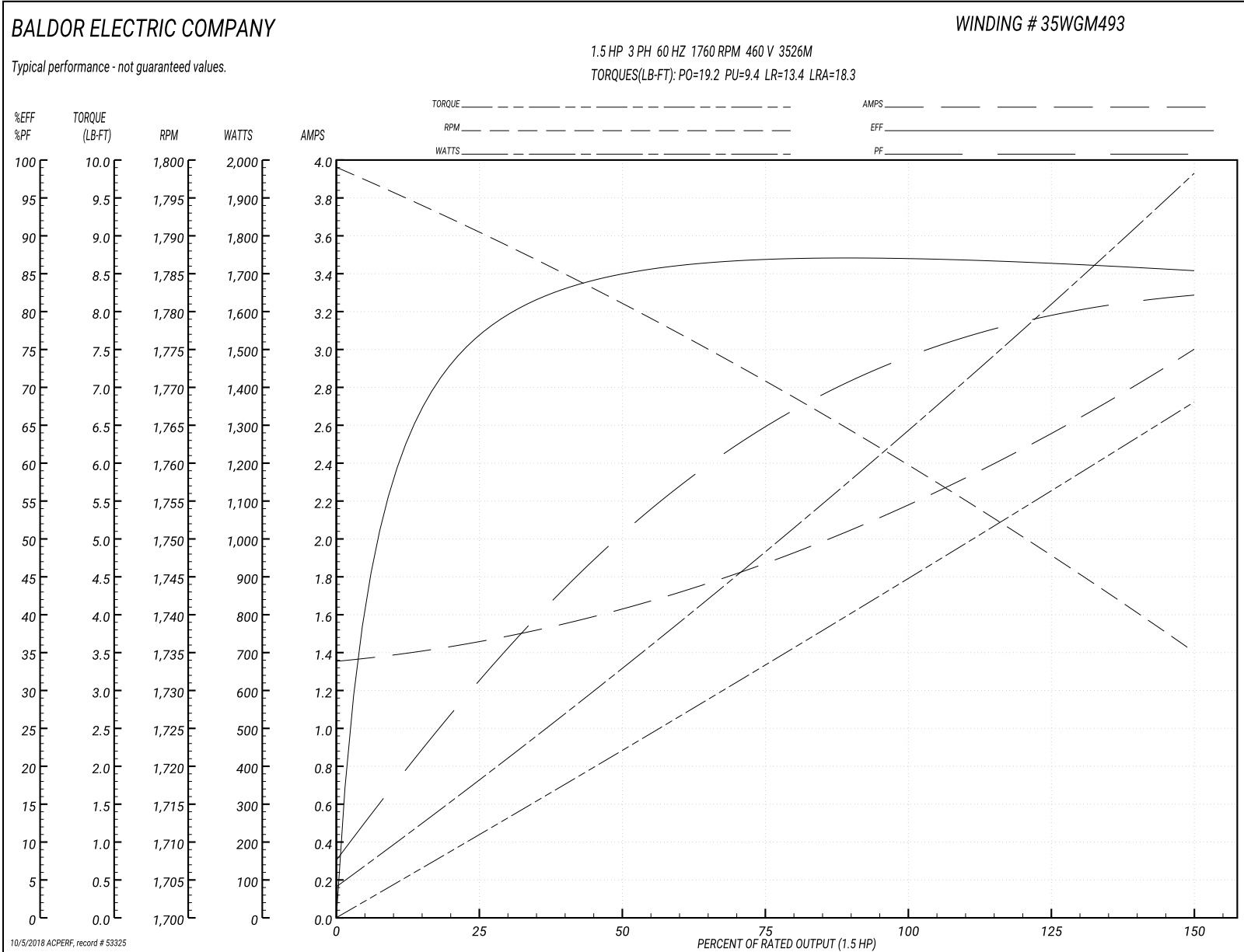

35LYZ063

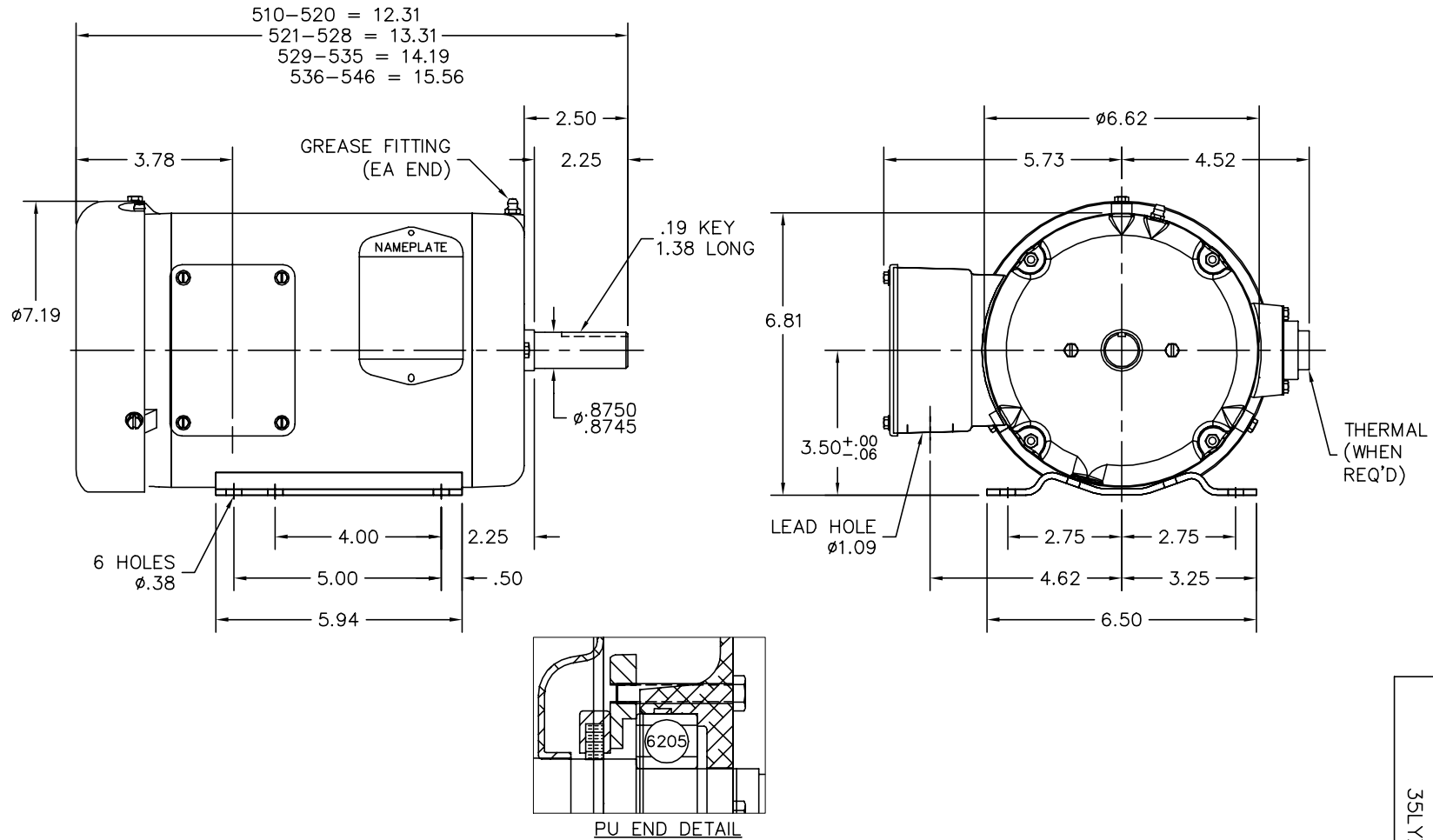

CUSTOMER IS RESPONSIBLE FOR DETERMINING THAT BALDOR'S PRODUCT WILL PERFORM SUITABLY IN THE INTENDED APPLICATION.

REV. DESC: REPLACE ENDPLATES		
REV. LTR: B	VERSION: 02	TDR: 000001064040
FILE: \AAA\00174\453	REVISED: 03:24:36 03/14/2018	BY: FGCHAH1
MTL: -		

BALDOR

HOR 143-5T TEFC M W/1.09 LEAD HOLE, AEGIS INT SHAFT GND

SH 1 of 1

35LYZ063

CD0005



LOW VOLTAGE
(2Y)



LINE

HIGH VOLTAGE
(1Y)



LINE

NOTES:

1. INTERCHANGE ANY TWO LINE LEADS TO REVERSE ROTATION.
2. OPTIONAL THERMOSTATS ARE PROVIDED WHEN SPECIFIED.
3. ACTUAL NUMBER OF INTERNAL PARALLEL CIRCUITS MAY BE A MULTIPLE OF THOSE SHOWN ABOVE.
4. LEAD COLORS ARE OPTIONAL. LEADS MUST ALWAYS BE NUMBERED AS SHOWN.

REV. DESC: REVISE TO SHOW OPTIONAL COLORS			
REV. LTR: E	BY: JLP	REVISED: 01/19/99 10:15	TDR: 0171435
900000		FILE: AAA00005140	MDL: -
		MTL: -	

BALDOR ELECTRIC Co.

3PH, DV, 9 LEADS

CD0005