

DATE:
September 13, 2006

CONNECTION DIAGRAM

CATALOG NO.:
EP1004C

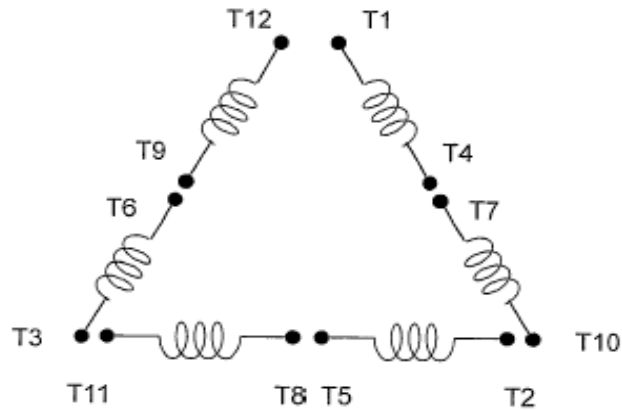

SCHEMATIC - Δ / Y CONNECTION

ACROSS THE LINE CONNECTION

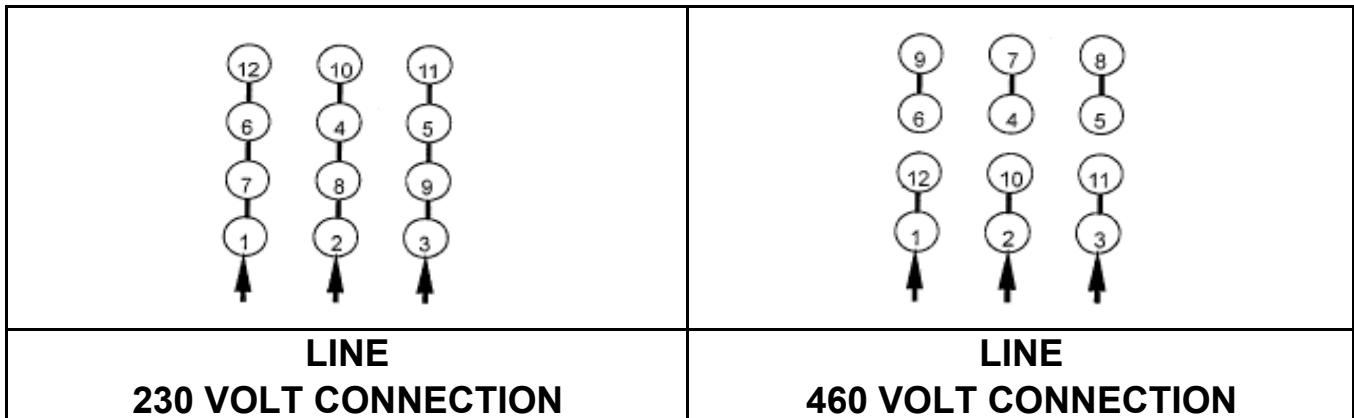

WYE START-DELTA RUN CONNECTION

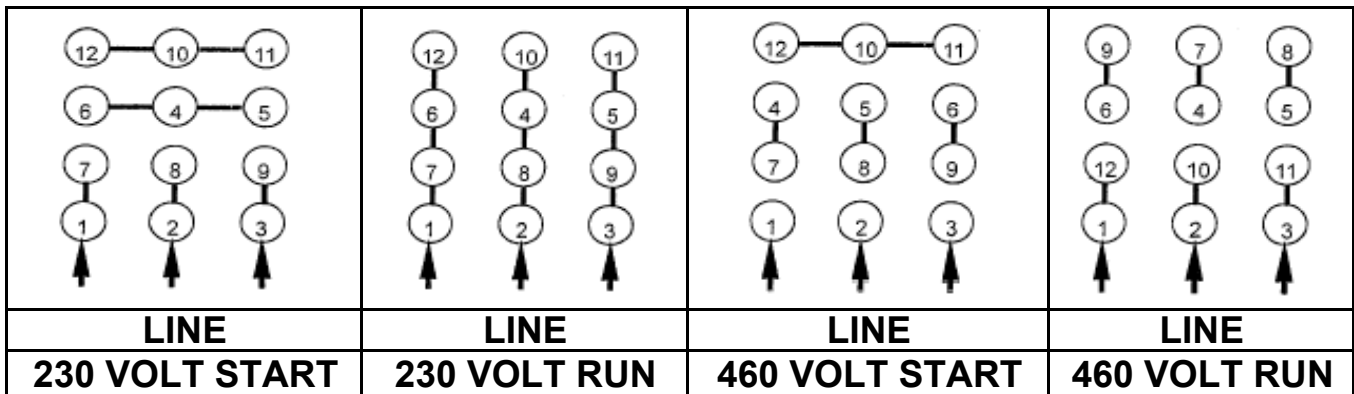

DWG NO.
DAC-1565-4