

DATE:
December 2, 2005

CONNECTION DIAGRAM

CATALOG NO.:
EP1256

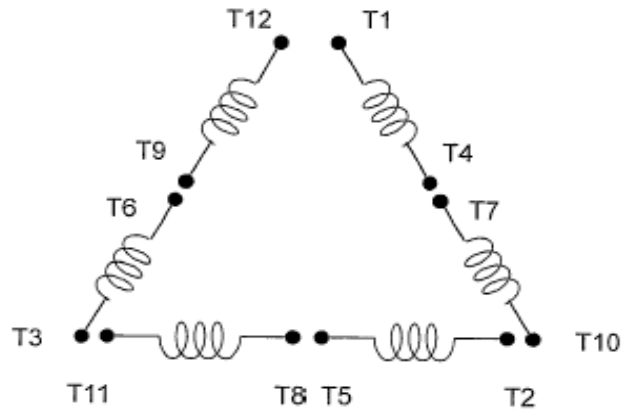

SCHEMATIC - Δ / Y CONNECTION

ACROSS THE LINE CONNECTION

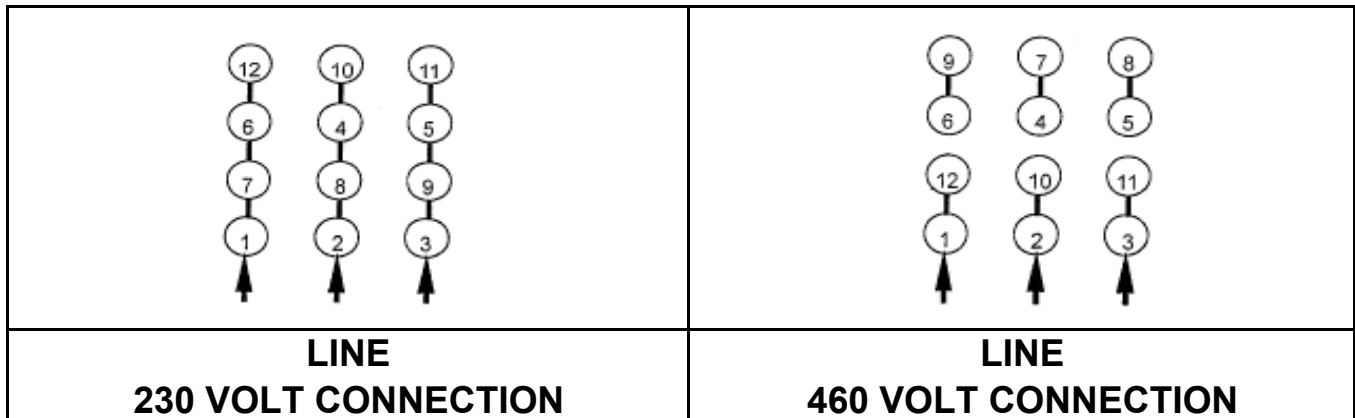

WYE START-DELTA RUN CONNECTION

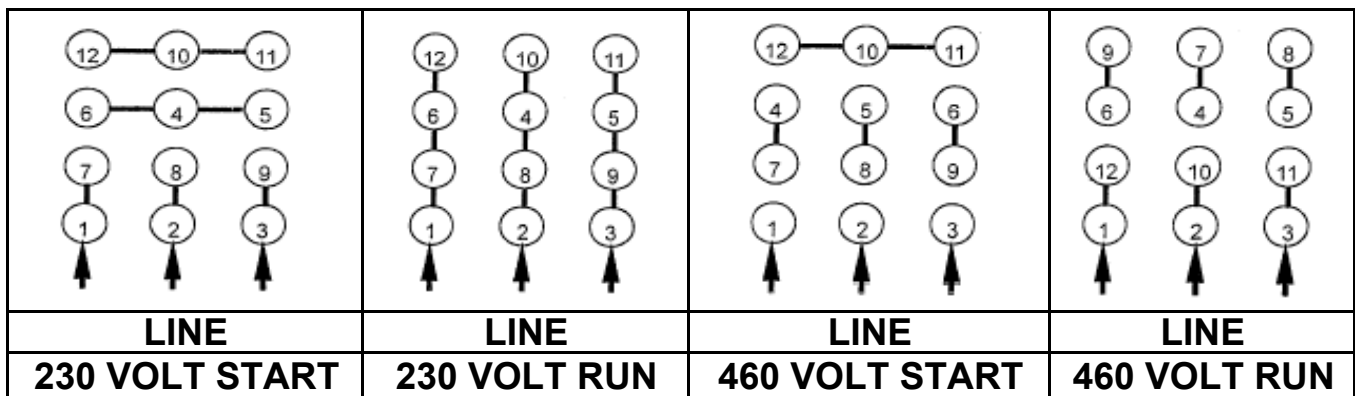

DWG NO.
DAC-1565-4