

BALDOR® • RELIANCE 

Product Information Packet

EWDM3710T

7.5HP, 1770RPM, 3PH, 60HZ, 213T, 3738M, TEFC, F

Part Detail							
Revision:	C	Status:	PRD/A	Change #:		Proprietary:	No
Type:	AC	Elec. Spec:	37WGR872	CD Diagram:	CD0005	Mfg Plant:	
Mech. Spec:	37H872	Layout:	37LYH872	Poles:	04	Created Date:	12-07-2015
Base:	RG	Eff. Date:	10-04-2017	Leads:	9#14		

Specs			
Catalog Number:	EWDM3710T	Heater Indicator:	No Heater
Enclosure:	TEFC	Insulation Class:	F
Frame:	213T	Inverter Code:	Inverter Ready
Frame Material:	Steel	KVA Code:	J
Output @ Frequency:	7.500 HP @ 60 HZ	Lifting Lugs:	Standard Lifting Lugs
Synchronous Speed @ Frequency:	1800 RPM @ 60 HZ	Locked Bearing Indicator:	No Locked Bearing
Voltage @ Frequency:	460.0 V @ 60 HZ	Motor Lead Quantity/Wire Size:	9 @ 14 AWG
	230.0 V @ 60 HZ	Motor Lead Termination:	Flying Leads
XP Class and Group:	None	Motor Type:	3738M
XP Division:	Not Applicable	Mounting Arrangement:	F1
Agency Approvals:	UR	Power Factor:	80
	CSA EEV	Product Family:	Wash Down
	CSA	Pulley End Bearing Type:	Sealed Bearing
Auxillary Box:	No Auxillary Box	Pulley Face Code:	Standard
Auxillary Box Lead Termination:	None	Pulley Shaft Indicator:	Standard
Base Indicator:	Rigid	Rodent Screen:	None
Bearing Grease Type:	Polyrex EM (-20F +300F)	RoHS Status:	ROHS COMPLIANT
Current @ Voltage:	19.000 A @ 230.0 V	Shaft Ground Indicator:	No Shaft Grounding

	20.000 A @ 208.0 V	Shaft Rotation:	Reversible
	9.500 A @ 460.0 V	Shaft Slinger Indicator:	Shaft Slinger
Design Code:	A	Speed Code:	Single Speed
Drip Cover:	No Drip Cover	Motor Standards:	NEMA
Duty Rating:	CONT	Starting Method:	Direct on line
Electrically Isolated Bearing:	Not Electrically Isolated	Thermal Device - Winding:	None
Feedback Device:	NO FEEDBACK	Vibration Sensor Indicator:	No Vibration Sensor
Front Shaft Indicator:	None	Winding Thermal 1:	None
		Winding Thermal 2:	None

Nameplate NP1669L										
CAT.NO.	EWDM3710T									
SPEC.	37H872R872G1									
HP	7.5									
VOLTS	230/460									
AMP	19/9.5									
RPM	1770									
FRAME	213T				HZ	60			PH	3
SER.F.	1.15		CODE	J	DES	A		CLASS	F	
NEMA-NOM-EFF	91.7		PF	80						
RATING	40C AMB-CONT									
CC	010A				USABLE AT 208V			20		
DE	6307				ODE	6206				
ENCL	TEFC			SN						
BLANK										

Parts List		
Part Number	Description	Quantity
SA311421	SA 37H872R872G1	1.000 EA
RA298846	RA 37H872R872G1	1.000 EA
37FN3002C01	EXFN, PLASTIC, 6.00 OD, 1.155 ID	1.000 EA
HW3200A01	3/8-16X3/4 I-BLT WELDED F/S	1.000 EA
37CB3005A04W	CASTING W/.75 NPT@6(MACH WHITE)	1.000 EA
37GS1025	37 MOLDED GASKET W/LIP, LEAD SEAL	1.000 EA
51XW2520A12	.25-20 X .75, TAPTITE II, HEX WSHR SLTD	2.000 EA
HA5027A01	HA4066A01 T-DRAIN X2 BAGGED	1.000 EA
11XW1032G06	10-32 X .38, TAPTITE II, HEX WSHR SLTD U	1.000 EA
37EP3101A94MW	FRONT TEFC L&M 206 BRG W/O GRSSR (WHITE)	1.000 EA
HW4032A01	BLACK DRAIN PLUG FOR WASH DOWN MOTORS	3.000 EA
HW5100A06	W2420-025 WVY WSHR (WB)	1.000 EA
37EP3100A20MW	FRONT ENDPLATE, MACHINED W/WHITE EPOXY	1.000 EA
HW4032A01	BLACK DRAIN PLUG FOR WASH DOWN MOTORS	3.000 EA
HW4600B51	SEAL 1.375 X 2.125 X 0.313 SINGLE LIP DB	1.000 EA
XY3118S12	5/16-18 HEX NUT, STAINLESS STEEL	4.000 EA
07FH4011	WASHDOWN IEC FH W/PRIMED	1.000 EA
11XW1032S06	SCREW, HXWSHR HD SLDTYF 410 SS	3.000 EA
37CB4512	CONDUIT BOX LID FOR WASHDOWN 37 FRAME	1.000 EA
37GS1008A02	37 GS FOR CB LID - WHITE NEOPRENE	1.000 EA
59XW0832S07	TAPTITE II,HEX WSHR UNSLTD SER,410 S.S.,	4.000 EA
HW4600B74	V-RING SLINGER 1.125 X 1.445 X .24 VITON	1.000 EA
HW4600B31SP	V-RING SLINGER 1.438 X 1.758 X .24 VITON	1.000 EA
HW2502F21	#303 SS,SQ KEY 5/16 X 2.375	1.000 EA

Parts List (continued)		
Part Number	Description	Quantity
HA7000A02	KEY RETAINER RING, 1 1/8 DIA, 1 3/8 DIA	1.000 EA
MJ5001A02	732 CL SEALANT 3 OZ DIXIE BEARING 289100	0.001 EA
MJ5001A27	32220KN GRAY SEALER *MIN BUY 4 QTS=1GAL	0.001 QT
LB1115N	LABEL,LIFTING DEVICE (ON ROLLS)	1.000 EA
LB1164	LABEL,WARNING AND DRAIN	1.000 EA
85XU0407S04	4X1/4 U DRIVE PIN STAINLESS	2.000 EA
MJ1000A02	GREASE, POLYREX EM EXXON (USe 4824-15A)	0.050 LB
51XB1214A20	12-14X1.25 HXWSSLD SERTYB	1.000 EA
MG1025Z02	ACTIVATOR WILKOFAS 060.02HF	0.010 GA
MG1025W01	WILKOFAS 781.01, SIGNAL WHITE #9003	0.028 GA
HA3104S17	THRUBOLT 13.250LG SS	4.000 EA
LC0005	CONN.DIA.,TY M,9-LD,DUAL VOLT,REVERSING	1.000 EA
NP1669L	SS WD SUPER-E UL CSA-EEV PREM REV MTG	1.000 EA
37PA1039	PALLET PACK GRP, PRINT PK1026A06	1.000 EA
MN416A01	TAG-INSTAL-MAINT no wire (1200/bx) 5/18	1.000 EA

Accessories		
Part Number	Description	Multiplier
37-3301	C FACE KIT	P1

AC Induction Motor Performance Data

Record # 54275 - Typical performance - not guaranteed values

Winding: 37WGR872-R001	Type: 3738M	Enclosure: TEFC
-------------------------------	--------------------	------------------------

Nameplate Data				460 V, 60 Hz: High Voltage Connection	
Rated Output (HP)	7.5			Full Load Torque	22.2 LB-FT
Volts	230/460			Start Configuration	direct on line
Full Load Amps	19/9.5			Breakdown Torque	70.9 LB-FT
R.P.M.	1770			Pull-up Torque	32.6 LB-FT
Hz	60	Phase	3	Locked-rotor Torque	43 LB-FT
NEMA Design Code	A	KVA Code	J	Starting Current	70.9 A
Service Factor (S.F.)	1.15			No-load Current	4.31 A
NEMA Nom. Eff.	91.7	Power Factor	80	Line-line Res. @ 25°C	1.41 Ω
Rating - Duty	40C AMB-CONT			Temp. Rise @ Rated Load	63°C
S.F. Amps				Temp. Rise @ S.F. Load	77°C
				Locked-rotor Power Factor	37.2
				Rotor inertia	0.934 LB-FT ²

Load Characteristics 460 V, 60 Hz, 7.5 HP

% of Rated Load	25	50	75	100	125	150	S.F.
Power Factor	42	64	75	80	83	84	82
Efficiency	87.1	91.6	92	92	91.1	89.8	91.5
Speed	1793	1786	1778	1770	1760	1750	1764
Line amperes	4.83	6.02	7.6	9.5	11.6	13.9	10.8

Performance Graph at 460V, 60Hz, 7.5HP Typical performance - Not guaranteed values

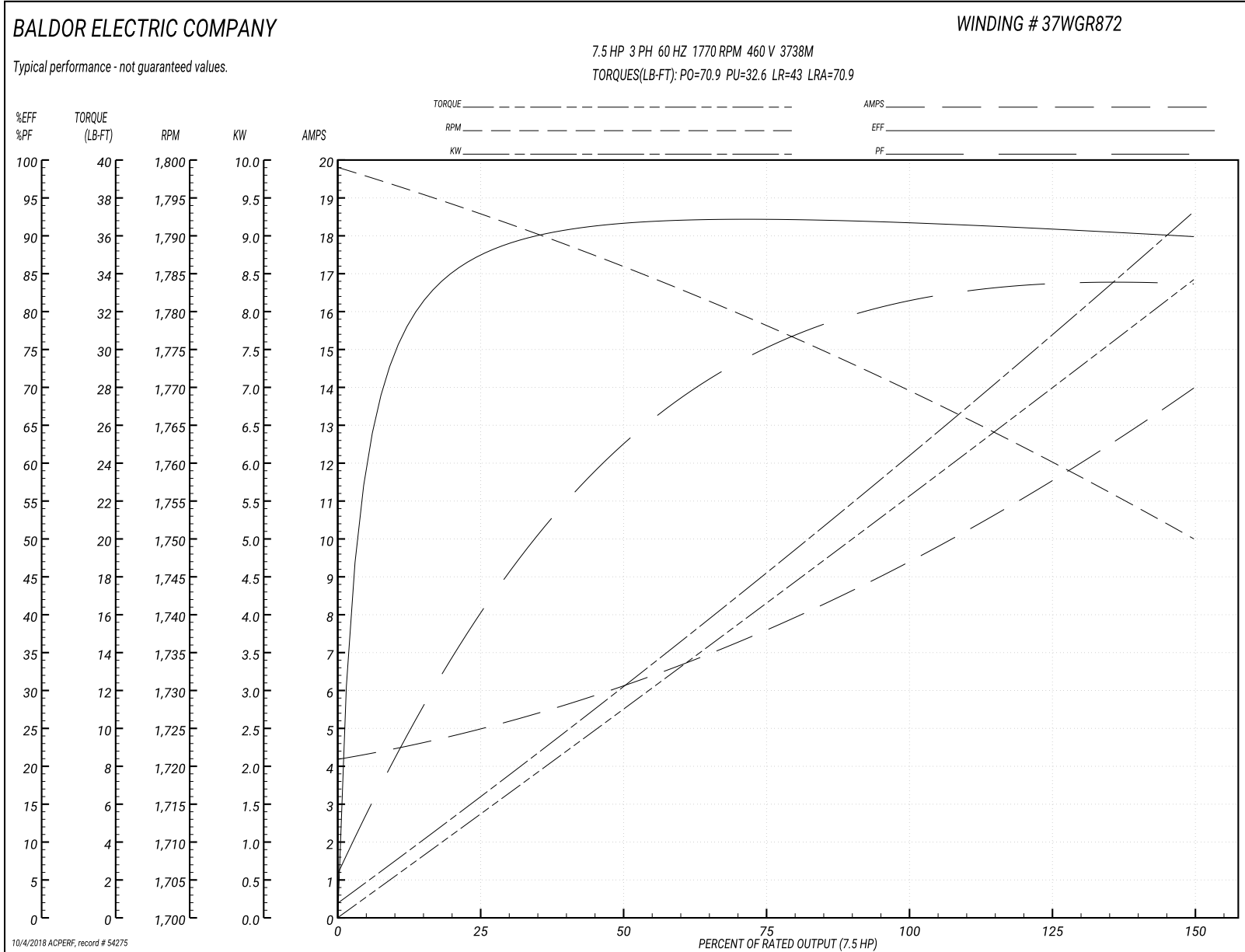

37LYH872

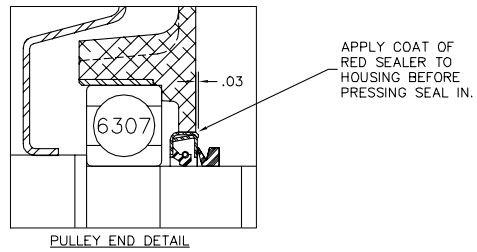
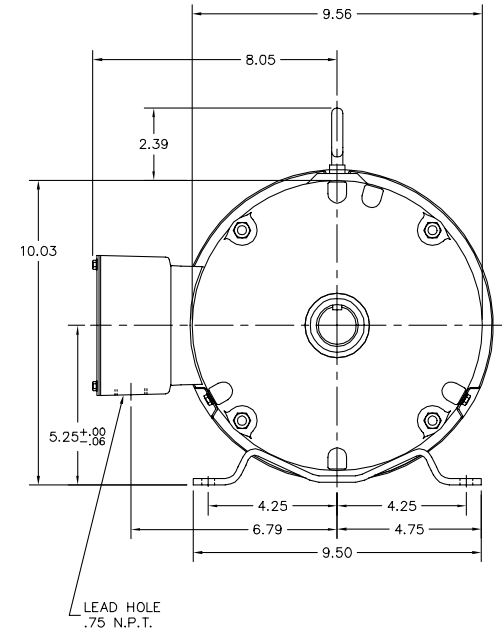
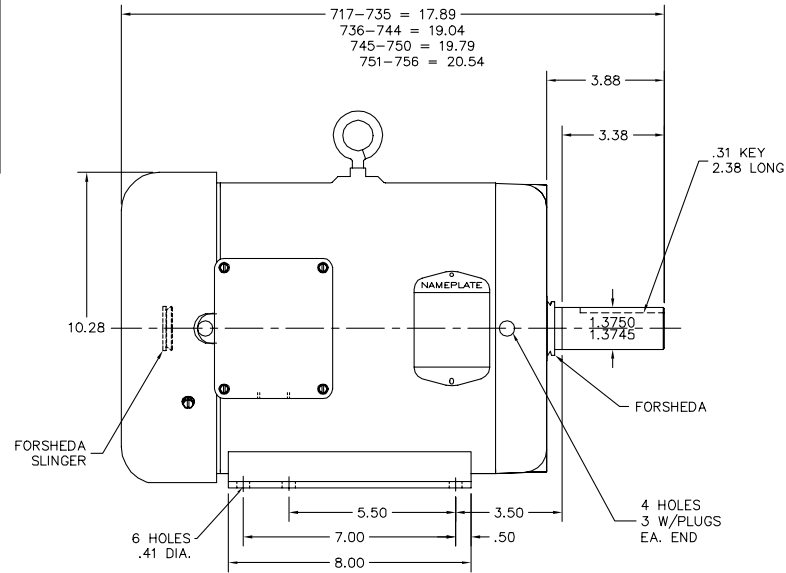

CUSTOMER IS RESPONSIBLE FOR DETERMINING THAT BALDOR'S PRODUCT WILL PERFORM SUITABLY IN THE INTENDED APPLICATION.

REV. DESC: REPLACE HA1005AD2 WITH HW4600B74	VERSION: 02	TDR: 000000783785
REV. LTR: B	REVISD: 02:55:02 05/03/2013	BY: ENCARJ0
FILE: \AAA\00093\031		
MTL: -		

BALDOR
 STD HORZ 213-5T TEFC 37M WD
 SH 1 of 1

37LYH872

CD0005

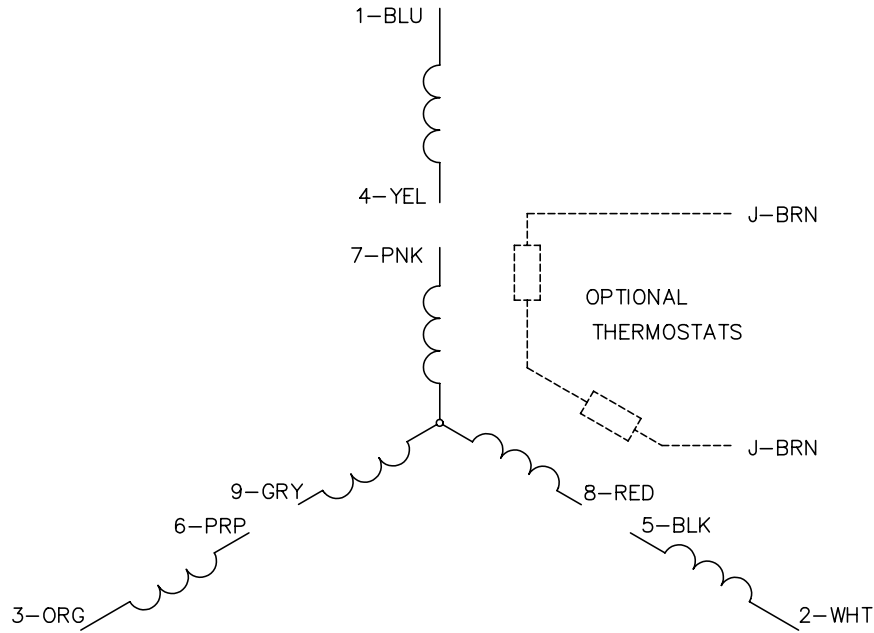

LOW VOLTAGE
(2Y)

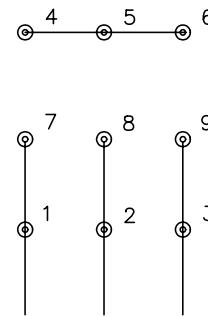

LINE

HIGH VOLTAGE
(1Y)

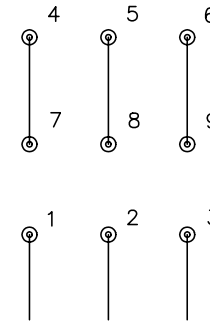

LINE

NOTES:

1. INTERCHANGE ANY TWO LINE LEADS TO REVERSE ROTATION.
2. OPTIONAL THERMOSTATS ARE PROVIDED WHEN SPECIFIED.
3. ACTUAL NUMBER OF INTERNAL PARALLEL CIRCUITS MAY BE A MULTIPLE OF THOSE SHOWN ABOVE.
4. LEAD COLORS ARE OPTIONAL. LEADS MUST ALWAYS BE NUMBERED AS SHOWN.

REV. DESC: REVISE TO SHOW OPTIONAL COLORS			
REV. LTR: E	BY: JLP	REVISED: 01/19/99 10:15	TDR: 0171435
900000		FILE: AAA00005140	MDL: -
		MTL: -	

BALDOR ELECTRIC Co.

3PH, DV, 9 LEADS

CD0005