

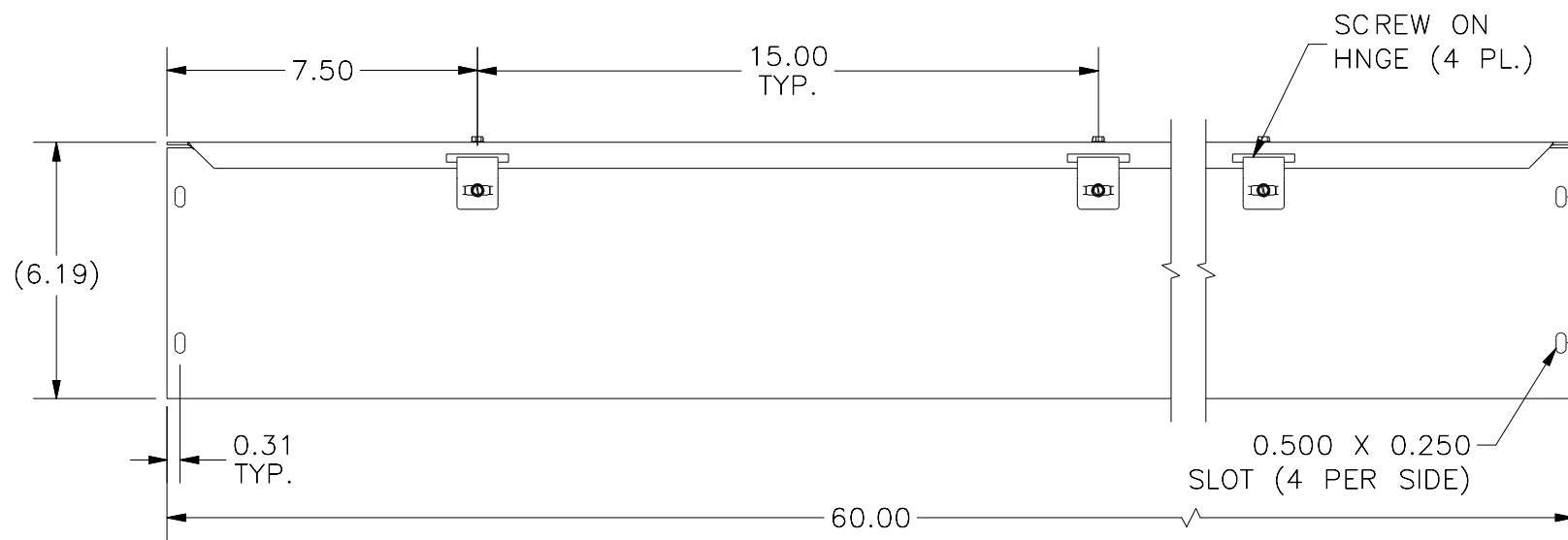

TOP VIEW

#10-32 X 3/8" SCREW,  
SELF-TAPPING (4 PL.)

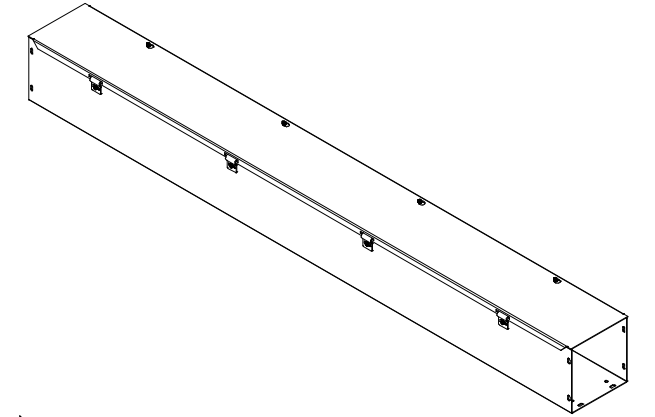

FRONT VIEW

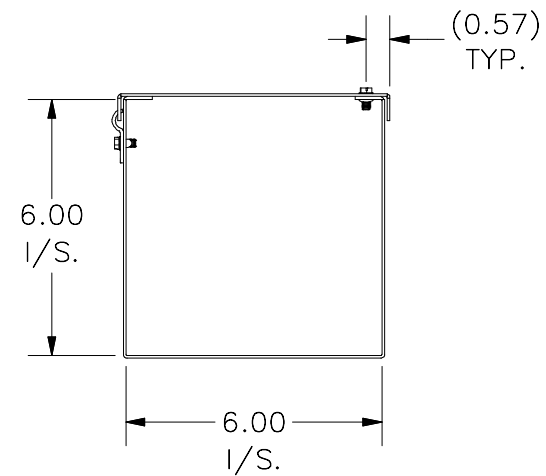

RIGHT VIEW



BOTTOM VIEW

PART#: HS665NK  
(DATA SUBJECT TO CHANGE WITHOUT NOTICE)

THIS DRAWING IS PROPERTY OF HUBBELL INC. WIEGMANN  
ALL INFORMATION IS PROPRIETARY AND NOT TO BE DUPLICATED