

**WORLDWIDE ELECTRIC CORPORATION**  
**HdR SERIES PROGRAM - WORM GEAR SPEED REDUCERS**  
**FLANGE INPUT - SHAFT OUTPUT - DIMENSIONS**

**MODEL # HdRF154-\*-R-56C**

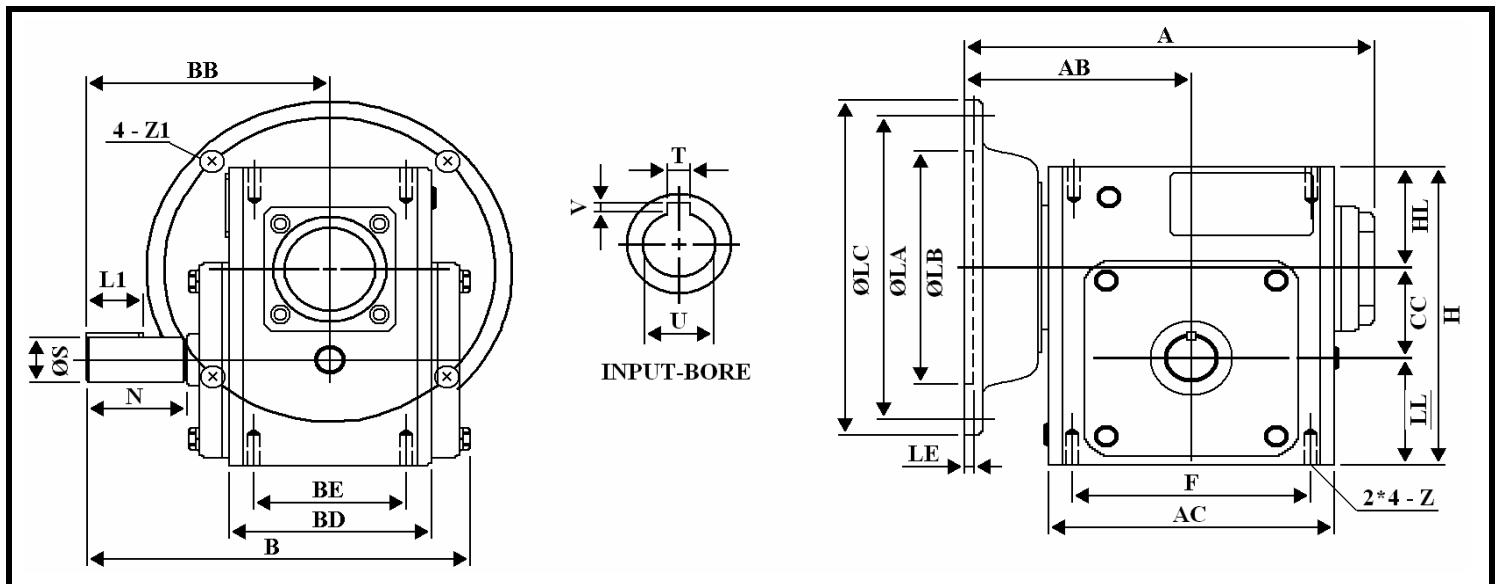
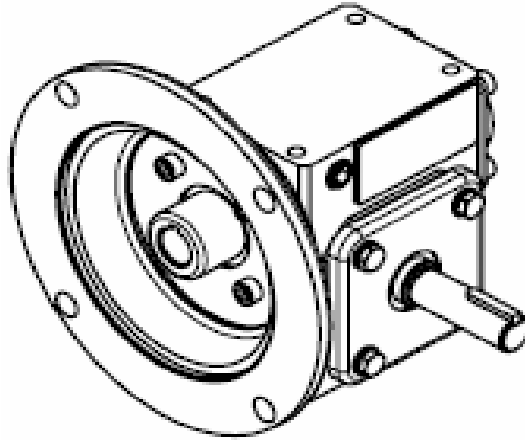

**RIGHT HAND OUTPUT - DIMENSIONS - Inches**

Size	A	AB	AC	B	BB	BD	BE	CC	F	H	HL	LL	N	Z
154	7.15	3.976	4.961	6.122	4.311	3.622	2.75	1.54	4.188	5.378	1.929	1.909	1.772	5/16-18 UNC

Size	INPUT BORE		OUTPUT SHAFT			FLANGE					NEMA FRAME	OIL (OZ.)
	U	T*V	L1	S	W*Y	LA	LB	LC	LE	Z1		
154	0.625	3/16 * 3/32	1	0.75	3/16 * 3/32	5.875	4.5	6.496	0.157	0.433	56C	11.64

\* Suitable For Any Ratio

