

WORLDWIDE ELECTRIC CORPORATION
HdR SERIES PROGRAM - WORM GEAR SPEED REDUCERS
FLANGE INPUT - HOLLOW BORE OUTPUT - DIMENSIONS

MODEL # HdRF206-*-H-56C

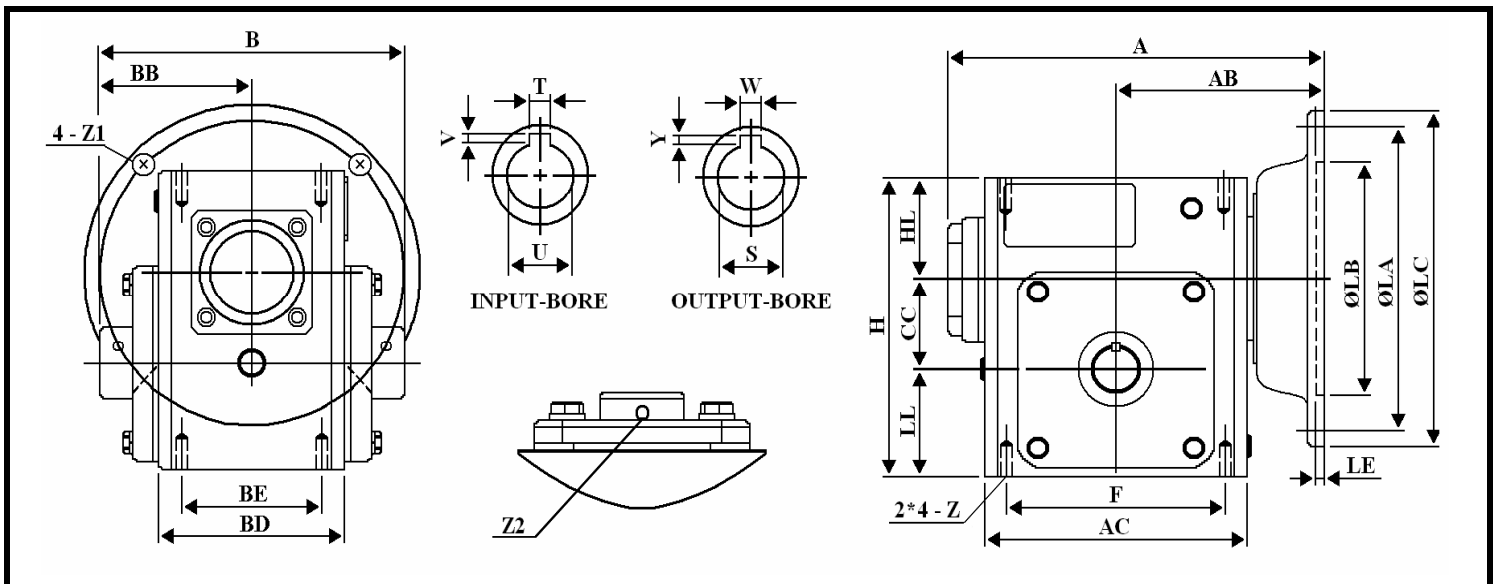
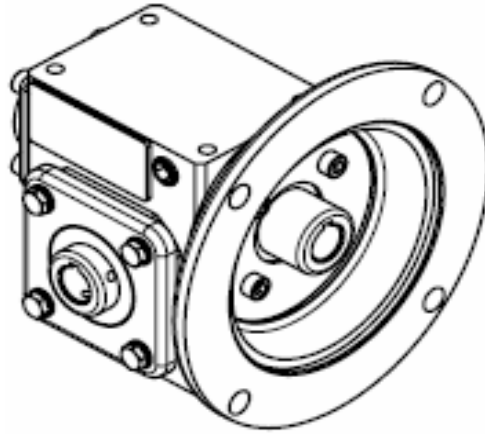

DIMENSIONS - Inches

Size	A	AB	AC	B	BB	BD	BE	CC	F	H	HL	LL	Z2	Z
206	7.95	4.37	5.748	6.44	3.219	3.819	2.88	2.062	5	6.375	2.032	2.281	1/4-28 UNF*3/8	3/8-16 UNC

Size	INPUT BORE		OUTPUT BORE		FLANGE					NEMA FRAME	OIL (OZ.)
	U	T*V	S	W*Y	LA	LB	LC	LE	Z1		
206	0.625	3/16 * 3/32	1.125	1/4 * 1/8	5.875	4.5	6.5	0.157	0.433	56C	19.41

* Suitable For Any Ratio

