

DATE  
Nov. 7, 2008  
Cat. #:

OUTLINE DIMENSIONS  
3-PHASE INDUCTION MOTOR

MOTOR TYPE:  
AEEAJM-NE  
FRAME NO. 213JM

Pole	HP	kW	Hz	VOLT	Syn. Speed r/min(rpm)
-	-	-	-	-	-

Ins	Rating	Dimension in	Approx Weight	Bearings
F	CONT.	inches	154 lbs.	DE: 6309ZZ NDE: 6306ZZ

Totally Enclosed Fan-Cooled Type. Squirrel-Cage Rotor.

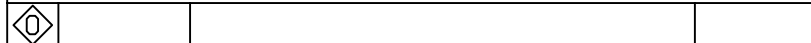
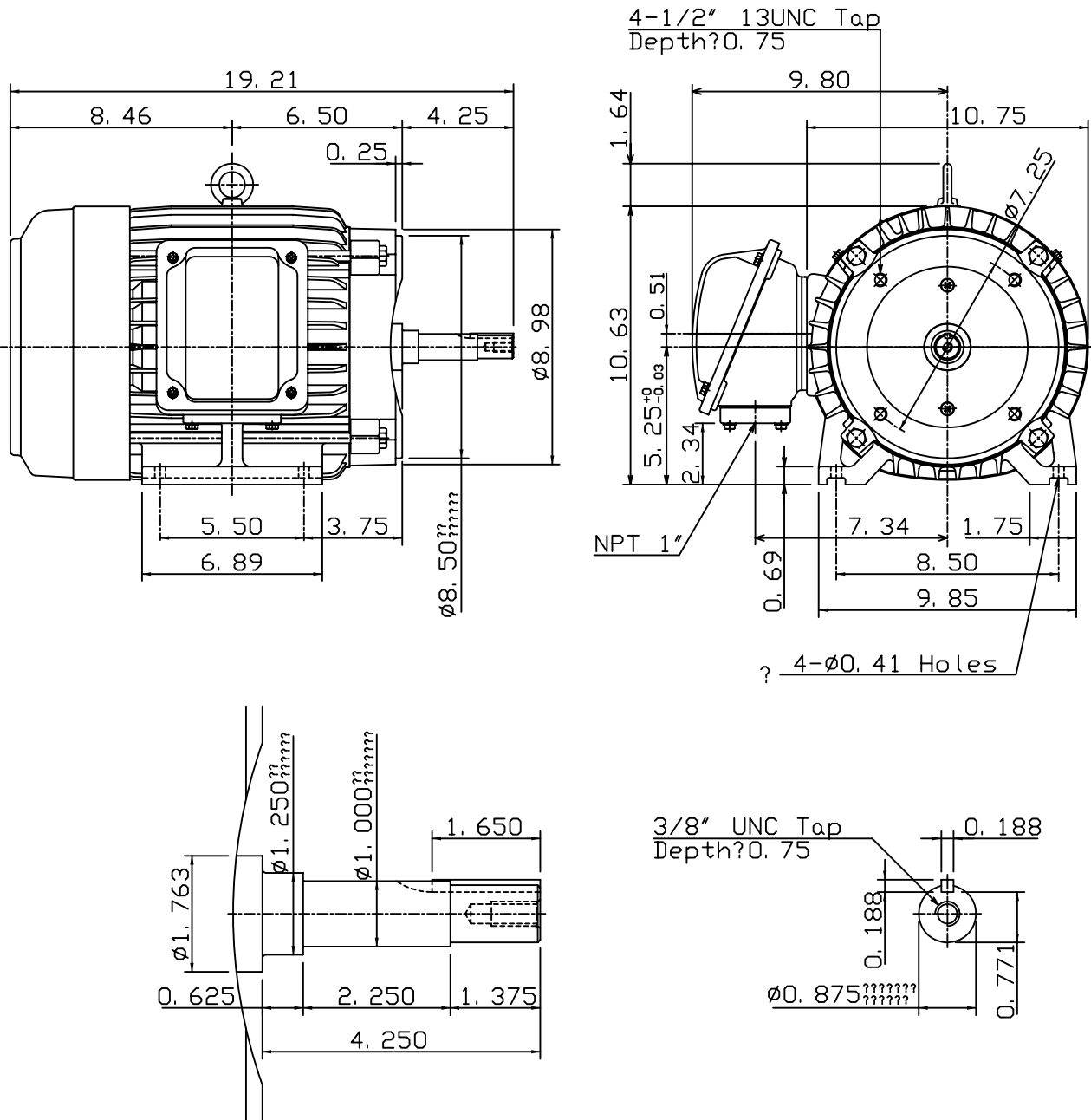

DWN.	J. H. LIANG	01-12-08
CHKD.	H. C. YAN	02-12-08
APPD.	M. C. TSAI	02-12-08



DWG NO.  
31049H741040