

TOP VIEW

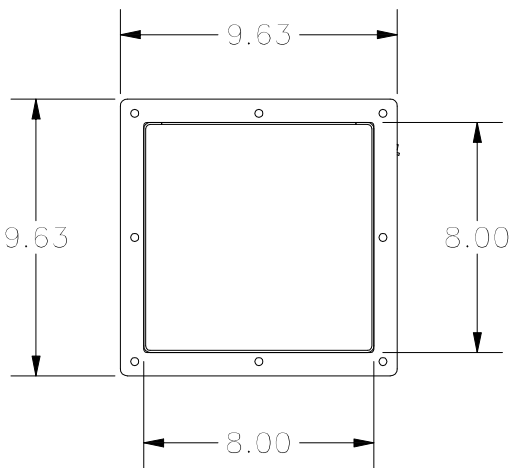

LEFT SIDE VIEW

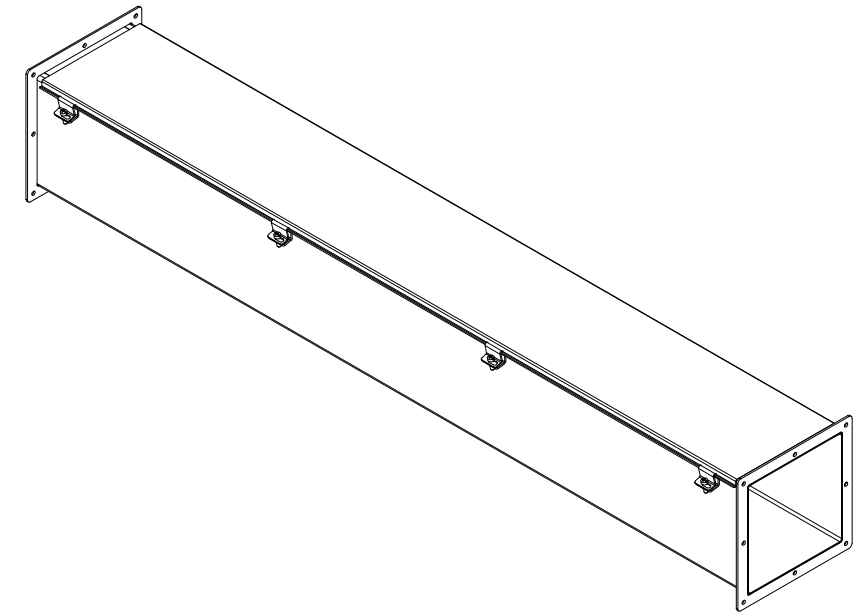
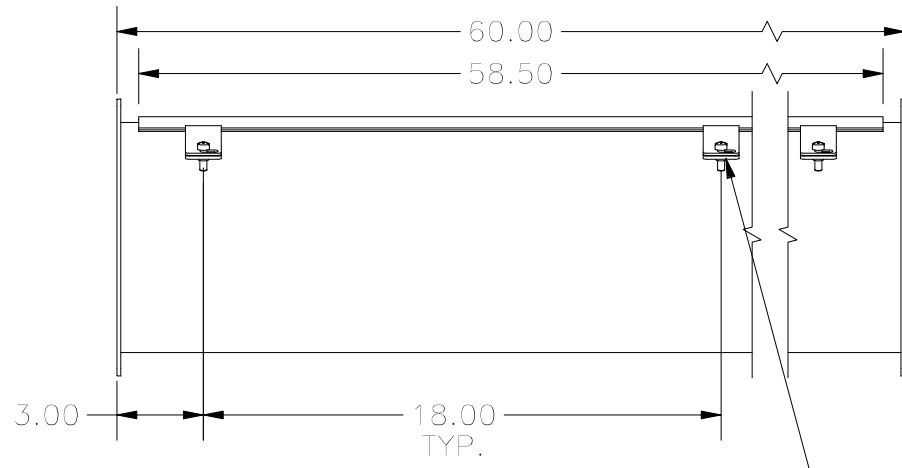

FRONT VIEW

JIC SCREW
CLAMPS
(4 PL.)

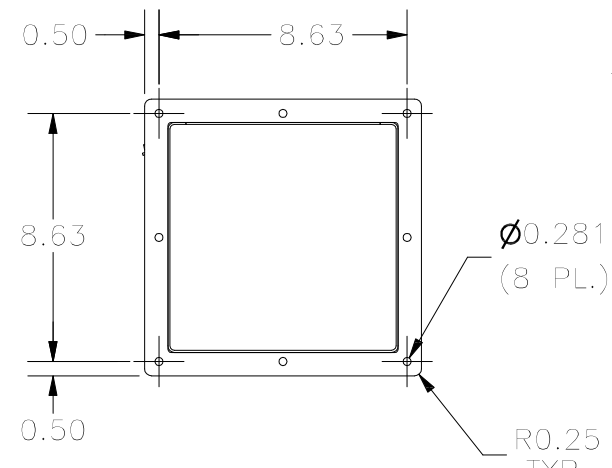

RIGHT SIDE VIEW

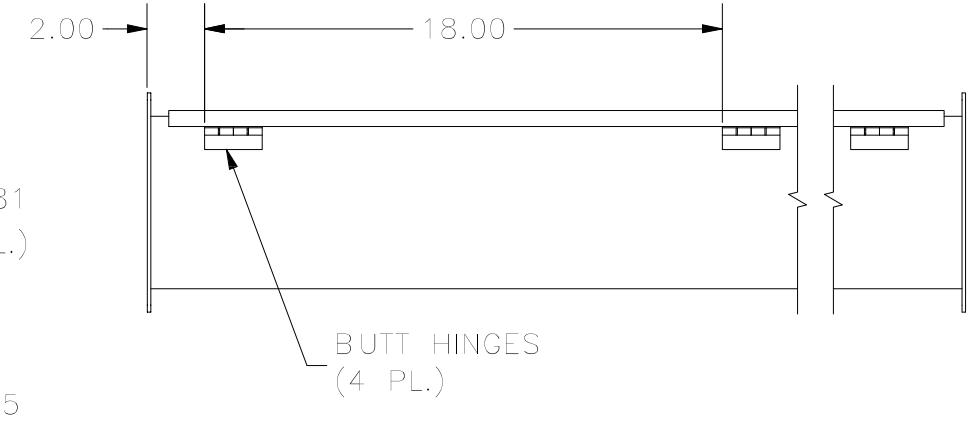

BACK VIEW



BOTTOM VIEW

PART#: JW85
(DATA SUBJECT TO CHANGE
WITHOUT NOTICE)

THIS DRAWING IS PROPERTY OF HUBBELL INC.
WIEGMANN
ALL INFORMATION IS PROPRIETARY AND NOT TO BE
DUPLICATED