

LEFT SIDE VIEW

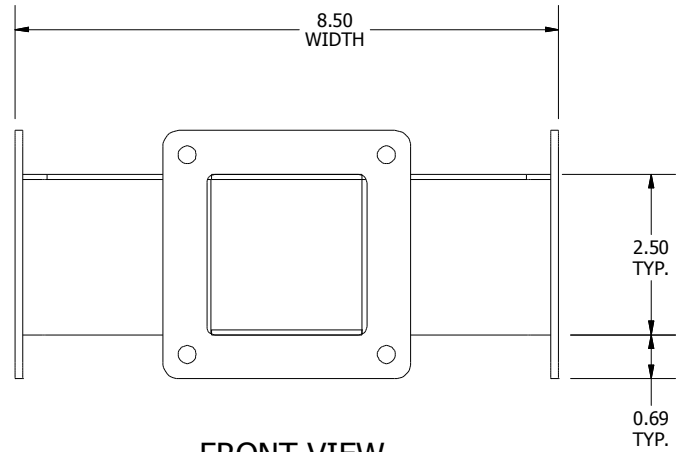

FRONT VIEW

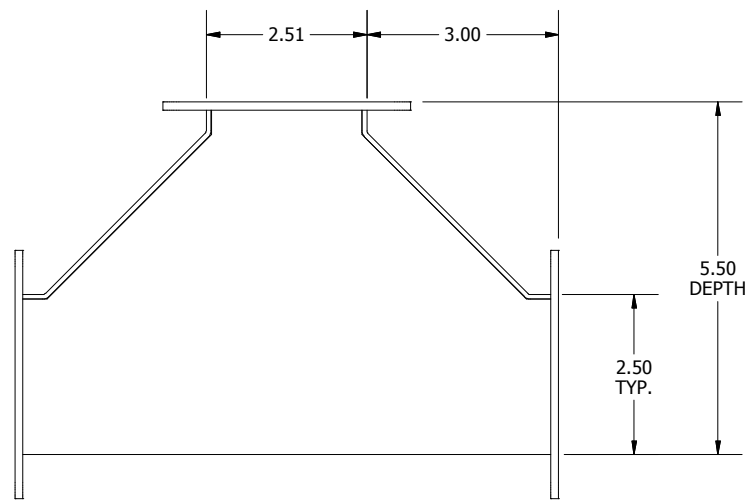

BOTTOM VIEW

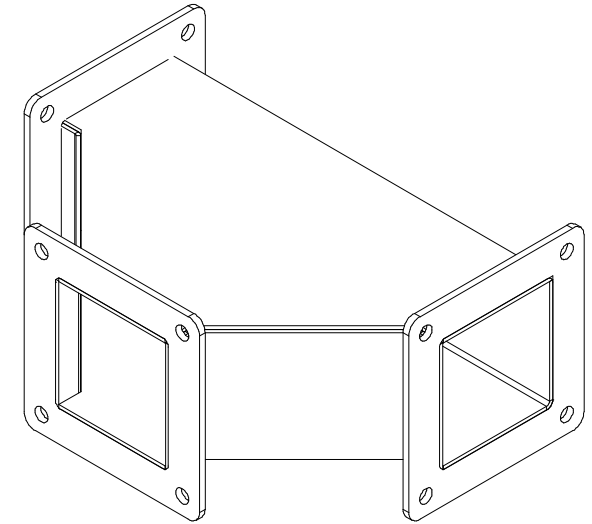

PART#: JWT2
 (DATA SUBJECT TO CHANGE WITHOUT NOTICE)

THIS DRAWING IS PROPERTY OF HUBBELL INC. WIEGMANN
 ALL INFORMATION IS PROPRIETARY AND NOT TO BE DUPLICATED