

TYPE	OUTPUT		POLE	TIME RATING	VOLTAGE V	Hz	SYN.SPEED R.P.M
	HP.	kW.					
AEHGK	200	149.2	6	CONT.	2300/4160	60	1200

TOTALLY ENCLOSED FAN-COOLED TYPE, SQUIRREL-CAGE ROTOR

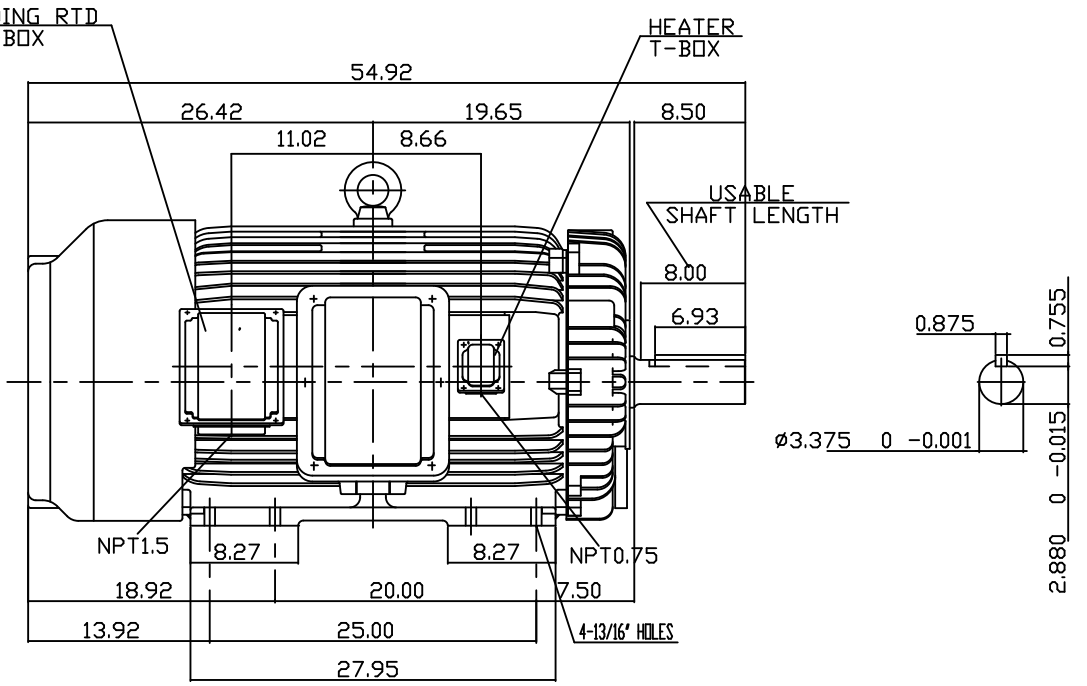
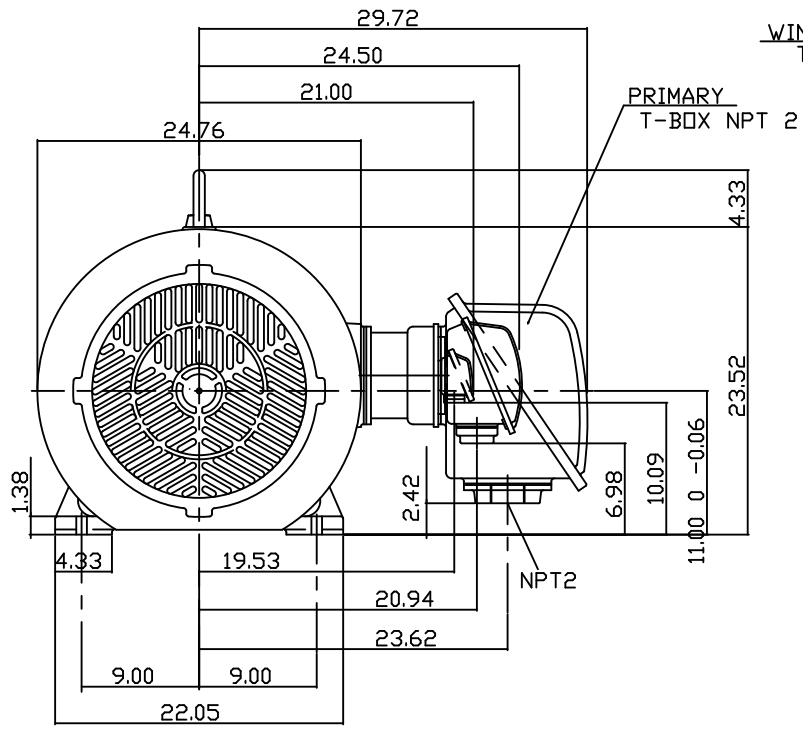

NOTE:

1. DIMENSIONS IN INCH
2. FRAME NO. 449T
3. F CLASS INSULATION, S.F.1.15
4. FOR DIRECT FLEXIBLE COUPLING
5. 100 OHM PLATINUM WINDING RTD
6. 120 VOLT SPACE HEATER AT 200 WATTS
7. BEARING SIZE DRIVE END: 6320
NON-DRIVE END: 6316
8. ENCLOSURE: IP54
9. APPROX. WEIGHT: 2930 LBS

TW-56C

DATE: OCT 12, 2013	OUTLINE DIMENSIONS
CATALOG # KG2006T	3-PHASE INDUCTION MOTOR
DWG NO. 3B040C101	REV: 00

DWN.	LKP	11-05-2013

