

Airborne contamination from the atmosphere, such as dust, water vapor and hydrocarbons enter the air system through the compressor intake. The contaminants, usually 4 million particles per cubic foot, can easily pass through a typical compressor intake filter since over 80% of these particles are less than 2 microns in size. The compressor also contributes to the problem with wear particles, oil vapor and fine aerosols that leak past glands and seals from the oil sump into the compression chamber.

Such contamination in the air system can effect the efficient operation of various pneumatic devices and, over time, damage them. Compressed air filters that are installed upstream of the air devices will remove most of these contaminants. In addition, these filters will also remove most liquid water from the air line.

To gain improved production efficiencies through automation, more sophisticated, technically advanced pneumatic equipment and instrumentation is being used throughout industry. Due to the critical nature of these applications, the need for extremely clean, virtually oil free air is required. Coalescing (oil removal) and oil vapor removal filters should be used for applications requiring high quality air.

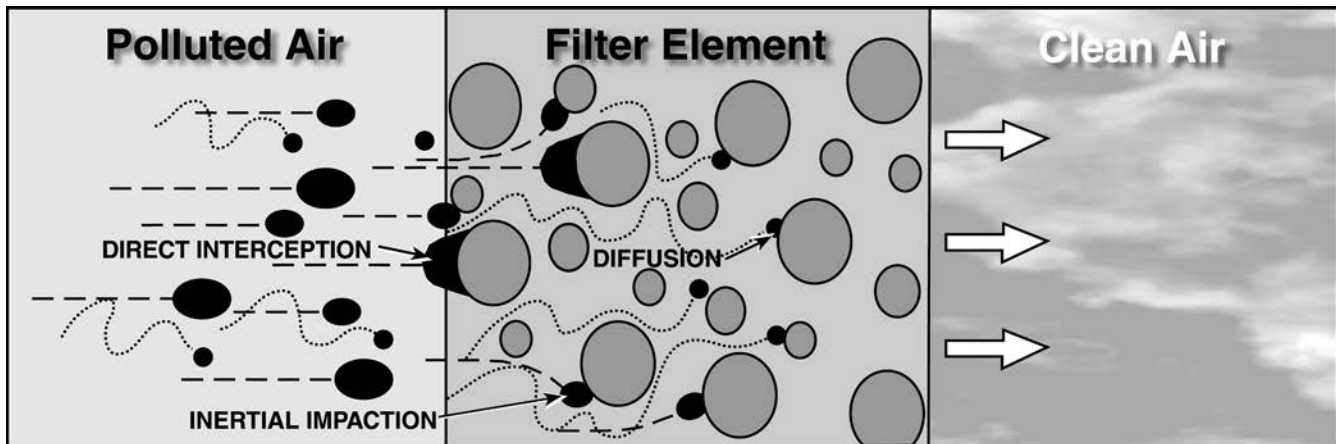

When Making Your Filter Selection:

1. Generally install filters downstream of aftercoolers / separators and air receivers at the lowest temperature point and as close to the point of application as possible. This reduces the chance of additional water and oil vapor condensing after the filter.
2. Filters should not be installed downstream of quick opening valves and should be protected from possible reverse flow or other shock conditions.
3. It may be necessary to install a combination of mainline filtration near the compressor installation before entry to the main air distribution system, as well as installing terminal filtration at the critical application points. Remember, especially in existing installations, the contamination already in the pipe system downstream of the filters will take a long time to disappear and probably never will completely.
4. Purge all lines leading from the filters to the final application to be protected.
5. Install filters in a vertical position ensuring that there is sufficient room below the filters to facilitate element change.
6. Provide a facility to drain away collected liquids from the filter drains via properly sized tubing, taking care there are no restrictions in the drain line.
7. Install a Wilkerson differential pressure gauge or pop-up indicator to monitor the pressure drop across the filters. This will provide an easy way of visually monitoring the filter element condition, indicating when to replace the element. If you have a problem with filter selection or installation please contact the factory.
8. It is recommended to pipe the system with bypass circuits and isolation valves for piping convenience and to minimize air system disruptions.

Particulate Filters

For the removal of solid particle contaminants down to 5 microns and the separation of bulk liquids. This type of filter is generally used in industrial applications where water, oil, and harmful dirt particles must be removed from the compressed air system. This type of filter should also be used as a prefilter for the Coalescing (oil removal) filter.

Operation

Wet and dirty inlet air is directed downward and outward in a circular pattern by the turbine-shaped upper baffle. This action mechanically separates a large amount of the liquid and gross particles, which then flow down the inside of the bowl, past the lower baffle, into the quiet zone to be drained away. The quiet zone baffle prevents the contaminants from reentering the air flow stream. The partially cleansed air then passes through the filter element. By utilizing depth filtration, the 5 micron filter provides superior filtration, exceptional service life and minimum pressure drop.

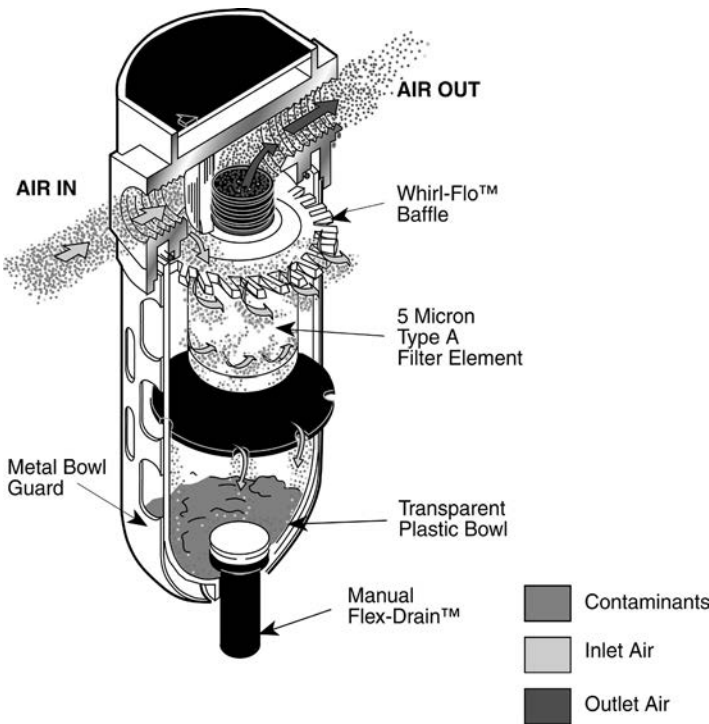

Coalescing Filters (Oil Removal)

Specifically designed for the removal of solid particles, water and oil aerosols down to 0.01 microns. The maximum remaining oil content of air leaving the filter drops down to 0.01ppm at 70°F (21°C) at a pressure of 100 PSIG (6,9 bar g) using a typical compressor lubricant. Specific end-use applications are protection of critical air control circuits, air logic systems, flow and temperature controllers, food processing, electronics, health care and film processing.

Operation

The filter element utilizes a borosilicate micro fiber that provides superior filtration efficiency, quick draining and minimum pressure drop. Unlike standard particle filters, air flow is inside to out. The compressed air / gas passes through the inner layer of the filter element which acts as an integral pre-filter to remove large contaminants. This gives protection to the layer of high efficiency filter material which substantially removes submicronic aerosols and solids from the air flow stream. Solid particles are permanently trapped within the filter media.

The fine liquid particles, including aerosols, after initially being trapped by the fibers of the filter media, begin to collect or coalesce forming larger droplets. These droplets, along with other large droplets present, are pushed to the outer surface. Here, the anti-reentrainment barrier collects the droplets as they break free from the micro fiber and allow them to gravitate within its cellular structure forming a "wet band" around the bottom of the element.

Clean filtered air / gas passes through the anti-reentrainment barrier above the "wet-band" where the resistance to flow is less, leaving a quiet zone of no air / gas movement in the bottom of the filter housing. The separated liquid drops from the bottom of the filter element and falls through without being re-entrained, to the bottom of the filter housing where it collects to be removed by a drain.

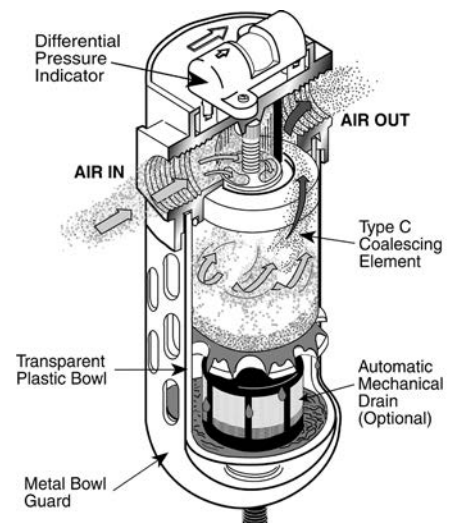

Wilkerson Compact Airline Filters

- 5 micron element
- 5 oz. bowl
- maximum operating conditions:
transparent bowl: **150 PSIG** (10.3 bar) and **32-125°F** (0-52°C)
metal bowl: **200 PSIG** (14 bar) and **32-150°F** (0-65.5°C)



with guard

Transparent Bowl with Guard

Size	SCFM	Automatic Drain Part #	Manual Drain Part #
1/4"	63.0	F16-02A	F16-02M
3/8"	74.1	F16-03A	F16-03M
1/2"	80.4	F16-04A	F16-04M

Metal Bowl with Sight Glass

Size	SCFM	Automatic Drain Part #	Manual Drain Part #
1/4"	63.0	F16-02AMB	F16-02MMB
3/8"	74.1	F16-03AMB	F16-03MMB
1/2"	80.4	F16-04AMB	F16-04MMB

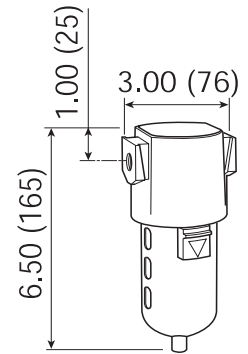

- **high flow capacity**
- 5 micron element
- 4 oz. bowl
- maximum operating conditions:
transparent bowl: **150 PSIG** (10.3 bar) and **32-125°F** (0-52°C)
metal bowl: **250 PSIG** (17.2 bar) and **32-175°F** (0-79°C)



transparent bowl with guard

Transparent Bowl with Guard

Size	SCFM	Automatic Drain Part #	Manual Drain Part #
1/4"	110	F18-02A	F18-02M
3/8"	120	F18-03A	F18-03M
1/2"	145	F18-04A	F18-04M

Metal Bowl with Sight Glass

Size	SCFM	Automatic Drain Part #	Manual Drain Part #
1/4"	110	F18-02AMB	F18-02MMB
3/8"	120	F18-03AMB	F18-03MMB
1/2"	145	F18-04AMB	F18-04MMB

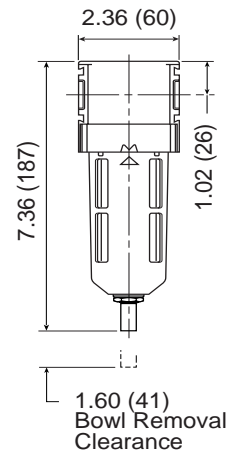

See pages 26 - 29 for filter accessories.



FRL's are designed for air service only, unless otherwise indicated.

SCFM ratings at 150 PSIG inlet pressure.

Wilkerson Standard Airline Filters

- 5 micron element
- 10 oz. bowl
- maximum operating conditions:
metal bowl: **200 PSIG** (13.8 bar) and **150°F** (0-65.5°C)
transparent bowl: **150 PSIG** (10.3 bar) and **32-125°F** (0-52°C)

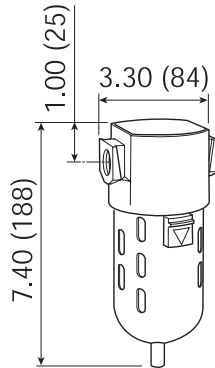

Transparent Bowl with Guard

Size	SCFM	Automatic Drain Part #	Manual Drain Part #
1/4"	81.3	F26-02A	F26-02M
3/8"	117.8	F26-03A	F26-03M
1/2"	149.8	F26-04A	F26-04M

Metal Bowl with Sight Glass

Size	SCFM	Automatic Drain Part #	Manual Drain Part #
1/4"	81.3	F26-02AMB	F26-02MMB
3/8"	117.8	F26-03AMB	F26-03MMB
1/2"	149.8	F26-04AMB	F26-04MMB



with guard

- **high flow capacity**
- 5 micron element
- 6 oz. bowl
- maximum operating conditions:
transparent bowl: **150 PSIG** (10.3 bar) and **32-125°F** (0-52°C)
metal bowl: **250 PSIG** (17.2 bar) and **32-175°F** (0-79°C)

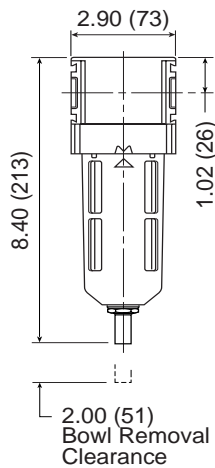

Transparent Bowl with Guard

Size	SCFM	Automatic Drain Part #	Manual Drain Part #
3/8"	144	F28-03A	F28-03M
1/2"	160	F28-04A	F28-04M
3/4"	165	F28-06A	F28-06M

Metal Bowl with Sight Glass

Size	SCFM	Automatic Drain Part #	Manual Drain Part #
3/8"	144	F28-03AMB	F28-03MMB
1/2"	160	F28-04AMB	F28-04MMB
3/4"	165	F28-06AMB	F28-06MMB



transparent bowl with guard

See pages 26 - 29 for filter accessories.

FRL's are designed for air service only, unless otherwise indicated.

**SAFETY
ALERT**

SCFM ratings at 150 PSIG inlet pressure.

Wilkerson Jumbo Airline Filters

- 5 micron element
- 1 qt. bowl
- maximum operating conditions:
transparent bowl: **150 PSIG** (10.3 bar) and **32-125°F** (0-52°C)
metal bowl: **200 PSIG** (13.8 bar) and **32-150°F** (0-65.5°C)



with guard

Transparent Bowl with Guard

Size	SCFM	Automatic Drain Part #	Manual Drain Part #
3/4"	316	F30-06A	F30-06M
1"	323	F30-08A	F30-08M

Metal Bowl with Sight Glass

Size	SCFM	Automatic Drain Part #	Manual Drain Part #
3/4"	316	F30-06AMB	F30-06MMB
1"	323	F30-08AMB	F30-08MMB

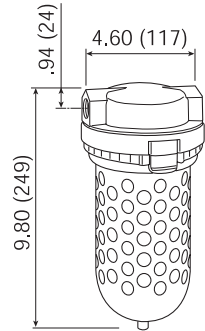

with metal bowl

- 5 micron element
- 1 qt. bowl
- maximum operating conditions:
metal bowl: **150 PSIG** (10.3 bar) and **32-150°F** (0-65.5°C)

Heavy Duty with Metal Bowl

Size	SCFM	Automatic Drain Part #	Manual Drain Part #
1½"	1280	F35-0BAMB	F35-0BMMB
2"	1400	F35-0CAMB	F35-0CMMB

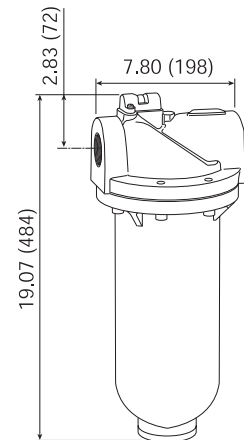

See pages 26 - 29 for filter accessories.



FRL's are designed for air service only, unless otherwise indicated.

SCFM ratings at 150 PSIG inlet pressure.

Wilkerson Modular Coalescing Filters

- for removal of extremely fine oil mists, oil aerosols and microscopic particles
- A standard airline filter should be installed as a pre-filter when using a coalescing filter.
- differential pressure indicator changes from green to red with pressure loss

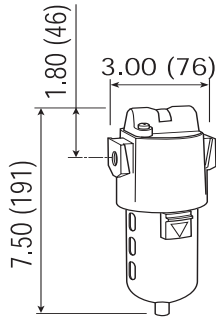

Compact Transparent Bowl with Guard

- 5 oz. transparent bowl
- 0.01 micron type C element
- can be installed in modular system
- maximum operating conditions:
transparent bowl: **150 PSIG** (10.3 bar) and **32-125°F** (0-52°C)

Size	SCFM	Automatic Drain Part #	Manual Drain Part #
1/4"	37.0	M16-02A	M16-02M
3/8"	44.7	M16-03A	M16-03M
1/2"	46.1	M16-04A	M16-04M



Standard Transparent Bowl with Guard

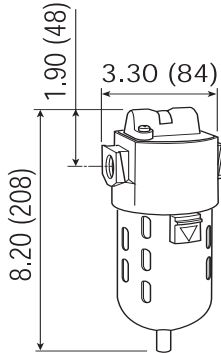

- 10 oz. transparent bowl
- 0.01 micron type C element
- can be installed in modular system
- maximum operating conditions:
transparent bowl: **150 PSIG** (10.3 bar) and **32-125°F** (0-52°C)

Size	SCFM	Automatic Drain Part #	Manual Drain Part #
1/4"	55.0	M26-02A	M26-02M
3/8"	65.5	M26-03A	M26-03M
1/2"	79.5	M26-04A	M26-04M



Jumbo Transparent Bowl with Guard

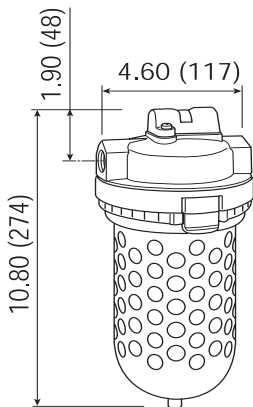

- 1 qt. transparent bowl
- 0.01 micron type C element
- maximum operating conditions:
transparent bowl: **150 PSIG** (10.3 bar) and **32-125°F** (0-52°C)

Size	SCFM	Automatic Drain Part #
1/2"	123	M30-04A
3/4"	173	M30-06A
1"	203	M30-08A



See pages 26 - 29 for filter accessories.

FRL's are designed for air service only, unless otherwise indicated.



SCFM ratings at 150 PSIG inlet pressure.

Wilkerson Heavy Duty Modular Coalescing Filters



- for removal of extremely fine oil mists, oil aerosols and microscopic particles
- A standard airline filter should be installed as a pre-filter when using a coalescing filter.
- differential pressure indicator changes from green to red with pressure loss



- 0.01 micron type C element
- 1 qt. metal bowl
- differential pressure indicator eliminates the guesswork of element placement
- maximum operating conditions:
transparent bowl: **150 PSIG** (10.3 bar) and **32-125°F** (0-52°C)
metal bowl: **250 PSIG** (17.2 bar) and **32-175°F** (0-79°C)

with Metal Bowl

Size	SCFM	Automatic Drain Part #
1 1/4"	741	M32-0AAMB

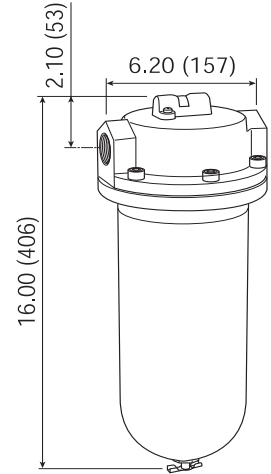

- 0.01 micron type C element
- 1 qt. metal bowl
- maximum operating conditions:
transparent bowl: **150 PSIG** (10.3 bar) and **32-125°F** (0-52°C)
metal bowl: **250 PSIG** (17.2 bar) and **32-175°F** (0-79°C)

with Metal Bowl

Size	SCFM	Automatic Drain Part #
1 1/2"	710	M35-0BAMB
2"	710	M35-0CAMB

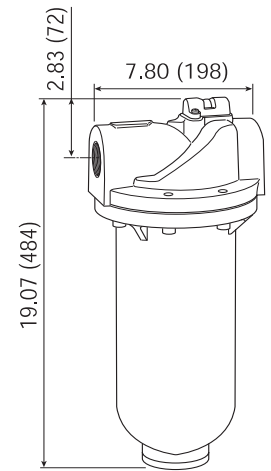

See pages 26 - 29 for filter accessories.



FRL's are designed for air service only, unless otherwise indicated.

SCFM ratings at 150 PSIG inlet pressure.

All pneumatic devices are designed to provide optimum performance and service life at a specific air pressure. While it is feasible to operate these devices at pressures in excess of the manufacturer’s recommended operating conditions, it is not advisable to do so. Operating at higher pressures can cause excessive wear and damage to the device. Operating your compressed air system at a higher-than-required pressure wastes energy and is not cost-effective.

To obtain the best operation and service life from your pneumatic equipment use the proper pressure level recommended by the manufacturer. A regulator (pressure control valve) is normally used to reduce and maintain a downstream pressure while the amount of air required to the device may vary with the demand. This type of regulator is generally used in a wide variety of applications where reduced pressure is highly desirable for energy conservation, safety requirements, air circuit control and air instrumentation.

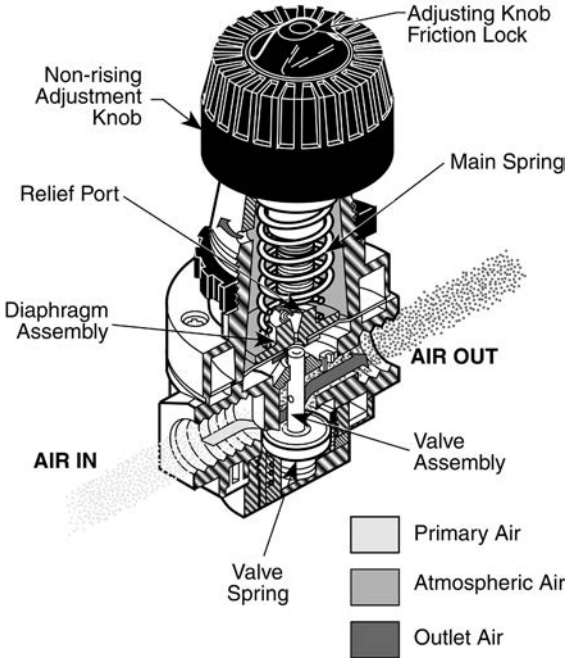

Operation

Turning the adjusting knob clockwise forces the main spring downward onto the flexible diaphragm which presses down onto the valve stem. The diaphragm and valve stem move downward forcing the balanced valve off its seat, which allows air to flow past the valve to the outlet side of the regulator and downstream to the air system. A precisely positioned aspirator tube communicates secondary pressure to the diaphragm resulting in instant compensation in order to maintain the desired secondary set pressure.

The diaphragm, valve stem and valve move upward, compressing the regulating main spring. Upward movement stops when the spring force acting on the diaphragm balances the pressure force acting below the diaphragm. For best performance, regulated pressure should always be set by increasing the pressure up to the desired setting.

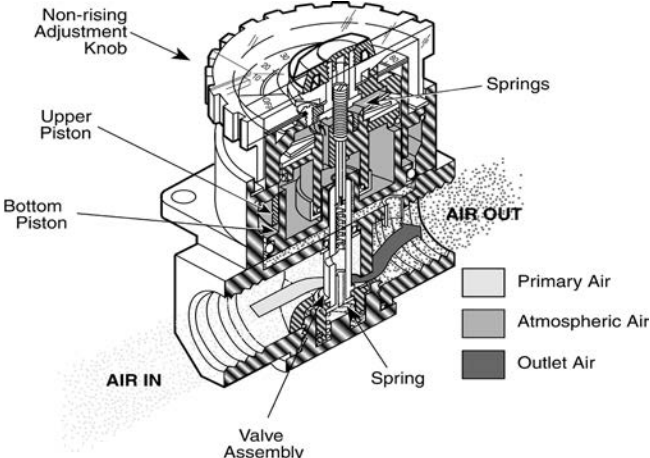

Wilkerson Dial Air Regulators

Dial-air regulators feature a transparent, pressure-calibrated, non-rising adjustment dial for quick adjustment of secondary pressure. The full reduced pressure range can be dialed in less than 270° of dial rotation. This feature is particularly advantageous if regulators can be mounted in any position so dial face is always visible. All dial-air units have a slight constant air bleed.



- **5-160 PSI** adjustable range
- relieving type
- non-rising pressure adjusting dial
- piston operated
- Two 1/4" NPT gauge ports located on the front and rear faces of the body. These ports may be used as additional regulated ports or for pressure gauges.
- with gauge models supplied with GC235 gauge
- balanced valve design
- maximum operating conditions:
300 PSIG (20.7 bar) and 32°F to 150°F (0°C to 65.5°C)

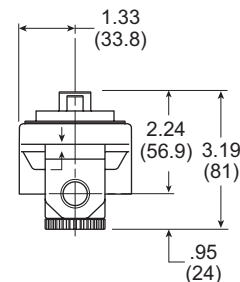

Size	SCFM	With Gauge Part #	Without Gauge Part #
1/4"	117	R21-02RG	R21-02R
3/8"	180	R21-03RG	R21-03R
1/2"	195	R21-04RG	R21-04R
3/4"	220	R21-06RG	R21-06R

Wilkerson Compact Regulators



- with gauge models supplied with GC230 gauge
- 5-25 PSI adjustment range
- for 0-60 PSI adjustment range, add an L to the end of the part number
- self-relieving standard
- can be installed with the adjusting knob in any position
- Two 1/4" NPT gauge ports located on the front and rear faces of the body. These ports may be used as additional regulated ports or for pressure gauges.
- with gauge models supplied with a GC230 gauge
- maximum operating conditions:
300 PSIG (20.7 bar) and 32°F to 150°F (0°C to 65.5°C)

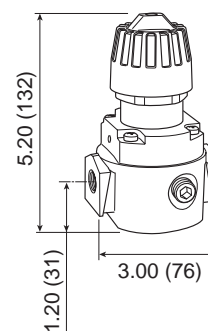

Size	SCFM	With Gauge Part #	Without Gauge Part #
1/4"	71.5	R16-02RG	R16-02R
3/8"	80.5	R16-03RG	R16-03R
1/2"	88.0	R16-04RG	R16-04R



- Two 1/4" NPT gauge ports located on the front and rear faces of the body. These ports may be used as additional regulated ports or for pressure gauges.
- with gauge models supplied with GC230 gauge
- 5-25 PSI adjustment range
- self relieving standard

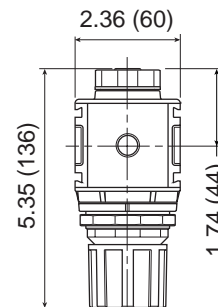

Size	SCFM	With Gauge Part #	Without Gauge Part #
1/4"	82	R18-02RG	R18-02R
3/8"	97	R18-03RG	R18-03R
1/2"	97	R18-04RG	R18-04R

See pages 29 - 31 for regulator accessories.



FRL's are designed for air service only, unless otherwise indicated.

SCFM ratings at 150 PSIG inlet pressure.

Wilkerson Standard Regulators

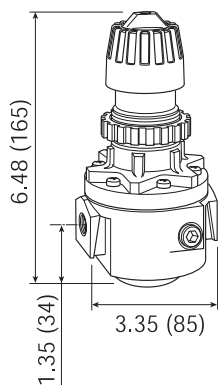

- 5-125 PSI adjusting range
- balanced valve design
- non-rising push/pull locking adjustment knob
- Two 1/4" NPT gauge ports located on the front and rear faces of the body. These ports may be used as additional regulated ports or for pressure gauges.
- panel mount nut standard
- excellent flow characteristics
- with gauge models supplied with GC230 gauge
- maximum operating conditions:
300 PSIG (20.7 bar) and 32-150°F (0-65.5°C)



Size	SCFM	With Gauge Part #	Without Gauge Part #
1/4"	112	R26-02RG	R26-02R
3/8"	148	R26-03RG	R26-03R
1/2"	185	R26-04RG	R26-04R

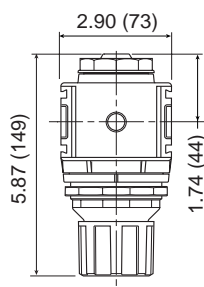

- 5-125 PSI adjusting range
- balanced valve design
- with gauge models supplied with GC230 gauge
- maximum operating conditions:
300 PSIG (20.7 bar) and 32-175°F (0-65°C)



Size	SCFM	With Gauge Part #	Without Gauge Part #
3/8"	162	R28-03RG	R28-03R
1/2"	170	R28-04RG	R28-04R
3/4"	176	R28-06RG	R28-06R

See pages 29 - 31 for regulator accessories.

FRL's are designed for air service only, unless otherwise indicated.

**SAFETY
ALERT**

SCFM ratings at 150 PSIG inlet pressure.

Wilkerson High Flow Regulators



- 10-125 PSI range
- balanced valve design
- can be installed with the adjusting knob in any position
- self-relieving standard
- heavy duty spring
- piston operated
- Two 1/4" NPT gauge ports located on the front and rear faces of the body. These ports may be used as additional regulated ports or for pressure gauges.
- with gauge models supplied with a GC230 gauge
- maximum operating conditions:

300 PSIG (20.7 bar) and **32-150°F** (0-65.5°C)

Size	SCFM	With Gauge Part #	Without Gauge Part #
3/4"	480	R30-06RG	R30-06R
1"	500	R30-08RG	R30-08R
1 1/4"	800	R30-0ARG	R30-0AR

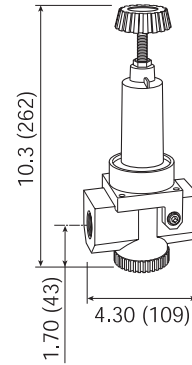

- 10-125 PSI range
- balanced valve design
- can be installed with the adjusting knob in any position
- self-relieving standard
- heavy duty spring
- piston operated
- Two 1/4" NPT gauge ports located on the front and rear faces of the body. These ports may be used as additional regulated ports or for pressure gauges.
- with gauge models supplied with a GC230 gauge
- maximum operating conditions:

300 PSIG (20.7 bar) and **32-150°F** (0-65.5°C)

Size	SCFM	With Gauge Part #	Without Gauge Part #
1 1/2"	1200	R40-0BRG	R40-0BR
2"	1200	R40-0CRG	R40-0CR

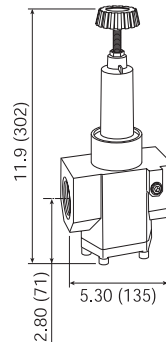

See pages 29 - 31 for regulator accessories.



FRL's are designed for air service only, unless otherwise indicated.

SCFM ratings at 150 PSIG inlet pressure.

Wilkerson High Pressure Regulators

Compact

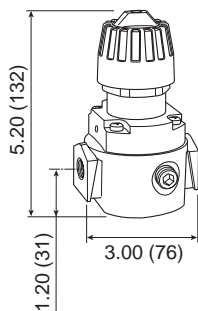

- 10-250 PSI range
- balanced valve design
- self-relieving standard
- heavy duty spring
- non-rising push/pull locking adjustment knob
- standard with two full flow 1/4" NPT gauge ports
- panel mount nut standard
- excellent flow characteristics
- supplied with GC240 gauge
- maximum operating conditions: **300 PSIG (20.7 bar) and 150°F (65.5°C)**



Size	SCFM	With Gauge Part #	Without Gauge Part #
1/4"	71.5	R16-02RHG	R16-02RH
3/8"	80.5	R16-03RHG	R16-03RH
1/2"	88	R16-04RHG	R16-04RH

Standard

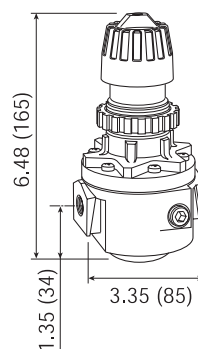

- 10-250 PSI range
- balanced valve design
- self-relieving standard
- heavy duty spring
- non-rising push/pull locking adjustment knob
- standard with two full flow 1/4" NPT gauge ports
- panel mount nut standard
- excellent flow characteristics
- supplied with GC240 gauge
- maximum operating conditions: **300 PSIG (20.7 bar) and 150°F (65.5°C)**



Size	SCFM	With Gauge Part #	Without Gauge Part #
1/4"	112	R26-02RHG	R26-02RH
3/8"	148	R26-03RHG	R26-03RH
1/2"	185	R26-04RHG	R26-04RH

High Flow

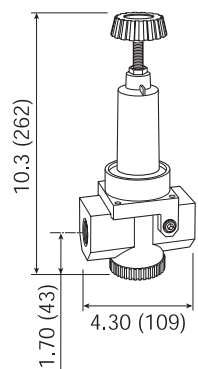

- 10-180 PSI range
- balanced valve design
- self-relieving standard
- heavy duty spring
- piston operated
- standard with two full flow 1/4" NPT gauge ports, ports can be used for additional outlet port
- supplied with GC240 gauge
- maximum operating conditions: **300 PSIG (20.7 bar) and 150°F (65.5°C)**



Size	SCFM	With Gauge Part #	Without Gauge Part #
3/4"	480	R30-06RHG	R30-06RH
1"	500	R30-08RHG	R30-08RH
1 1/4"	800	R30-0ARHG	R30-0ARH

High Flow

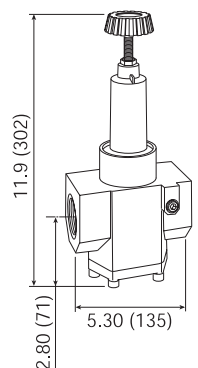

Size	SCFM	With Gauge Part #	Without Gauge Part #
1 1/2"	1200	R40-0BRHG	R40-0BRH
2"	1200	R40-0CRHG	R40-0CRH



See pages 29 - 31 for regulator accessories.

FRL's are designed for air service only, unless otherwise indicated.



SCFM ratings at 150 PSIG inlet pressure.

Wilkerson Compact Filter / Regulators

Over-under units are space savers and provide for installation in tight areas. One common inlet/outlet for both filter and regulator saves on piping costs.

- **0-125 PSIG** adjustable range
- 5 micron rated reusable element
- 5 oz. bowl
- self-relieving standard
- balanced valve design
- supplied with GC230 gauge
- diaphragm operated
- quick-disconnect bowl guard with integral plastic bowl and safety latch standard
- two 1/4" gauge ports
- maximum operating conditions:
transparent bowl: **150 PSIG** (10.3 bar) and **32-125°F** (0-52°C)
metal bowl: **200 PSIG** (13.8 bar) and **32-150°F** (65.5°C)

Transparent Bowl with Guard

Size	SCFM	Automatic Drain Part #	Manual Drain Part #
1/4"	64	CB6-02AG	CB6-02MG
3/8"	70	CB6-03AG	CB6-03MG
1/2"	70	CB6-04AG	CB6-04MG



metal bowl

Metal Bowl with Sight Glass

Size	SCFM	Automatic Drain Part #	Manual Drain Part #
1/4"	64	CB6-02AGMB	CB6-02MGMB
3/8"	70	CB6-03AGMB	CB6-03MGMB
1/2"	70	CB6-04AGMB	CB6-04MGMB

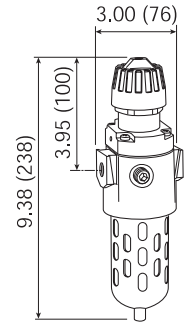

- high flow capacity
- **5-125 PSIG** adjustable range
- 5 micron filter
- 4 oz. bowl
- balanced valve design
- spring-loaded diaphragm
- maximum operating conditions:
transparent bowl: **150 PSIG** (10.3 bar) and **32-125°F** (0-52°C)
metal bowl: **250 PSIG** (17.2 bar) and **32-150°F** (0-79°C)
- supplied with a GC230 gauge

Transparent Bowl with Guard

Size	SCFM	Automatic Drain Part #	Manual Drain Part #
1/4"	88	B18-02AG	B18-02MG
3/8"	117	B18-03AG	B18-03MG
1/2"	121	B18-04AG	B18-04MG



with metal bowl

Metal Bowl with Sight Glass

Size	SCFM	Automatic Drain Part #	Manual Drain Part #
1/4"	88	B18-02AGMB	B18-02MGMB
3/8"	117	B18-03AGMB	B18-03MGMB
1/2"	121	B18-04AGMB	B18-04MGMB

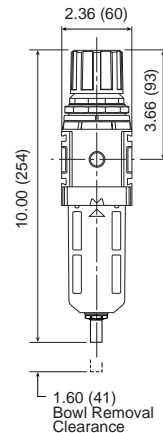

See pages 36-37 for filter / regulator accessories.



FRL's are designed for air service only, unless otherwise indicated.

SCFM ratings at 150 PSIG inlet pressure.

Wilkerson Standard Filter / Regulators

- high flow capacity
- **5-125 PSIG** adjustable range
- 5 micron filter
- 6 oz. bowl
- balanced valve design
- spring-loaded diaphragm
- maximum operating conditions:
transparent bowl: **150 PSIG** (10.3 bar) and **32-125°F** (0-52°C)
metal bowl: **250 PSIG** (17.2 bar) and **32-150°F** (0-79°C)
- supplied with a GC230 gauge

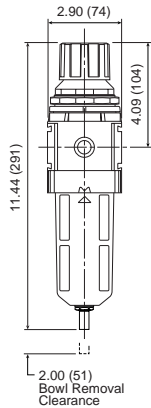

Transparent Bowl with Guard

Size	SCFM	Automatic Drain Part #	Manual Drain Part #
3/8"	140	B28-03AG	B28-03MG
1/2"	165	B28-04AG	B28-04MG
3/4"	175	B28-06AG	B28-06MG

Metal Bowl with Sight Glass

Size	SCFM	Automatic Drain Part #	Manual Drain Part #
3/8"	140	B28-03AGMB	B28-03MGMB
1/2"	165	B28-04AGMB	B28-04MGMB
3/4"	175	B28-06AGMB	B28-06MGMB



with metal bowl

See pages 36-37 for filter / regulator accessories.

FRL's are designed for air service only, unless otherwise indicated.

SAFETY
ALERT

SCFM ratings at 150 PSIG inlet pressure.

Getting the proper lubrication to the proper device at the proper time is fundamental to preventative maintenance, longer service life and increased productivity. The efficiency of air motors, control valves, cylinders and other air actuators can be greatly enhanced when the proper amount of lubrication is supplied.

Air line lubricators are specifically designed to generate and introduce an oil aerosol (mist) into the compressed air flow. The air flow then carries the oil to the pneumatic devices where the lubricant mist coats the moving and sliding surfaces thus reducing friction and wear.

To provide satisfactory lubrication to your air devices most lubricators have a proportional delivery system. This feature automatically provides a nearly constant oil-to-air ratio over a wide range of air flows.

Operation

For proper operation there must be line pressure in the reservoir bowl. As the air flows through the lubricator, some of the incoming air passes through the bowl pressure control valve which then pressurizes the bowl pushing oil upward through the siphon tube. Most of the air flow passes through the self-adjusting Flow-Guide® flow sensor in the lubricator throat creating a slight pressure drop that is proportional to the rate of air flow. The pressure drop is sensed by the sight dome and the adjustment needle valve allowing oil to flow upward through the siphon tube into the sight dome where it drips into a nozzle passage and then into the lubricator throat.

The precise amount of oil to be delivered to the air stream is determined by the oil adjusting needle valve which sets the exact drip rate. The oil drops are atomized by the high velocity air flowing through the lubricator. All of the drops visible in the sight dome are delivered downstream to the air devices.

The self-adjusting flow sensor automatically maintains a constant oil to-air ratio by opening and closing in response to a wide range of changing air flows. A check valve keeps the siphon tube full of oil during periods of no flow and prevents oil carry-over due to the possibility of reverse flow.

The pressurizing valve controls the rate of bowl pressurization and allows depressurization for refilling the unit without shutting off the supply air. When the oil fill plug is loosened, a spring loaded 2-way valve closes, allowing the air pressure in the bowl to be gradually reduced. When the fill plug is replaced, the bowl repressurizes through the pressure control valve. Upon initial use, or if unit has been run dry, open oil adjustment wide open until no air bubbles are visible in sight dome. Then, reset oil feed adjustment to desired setting.

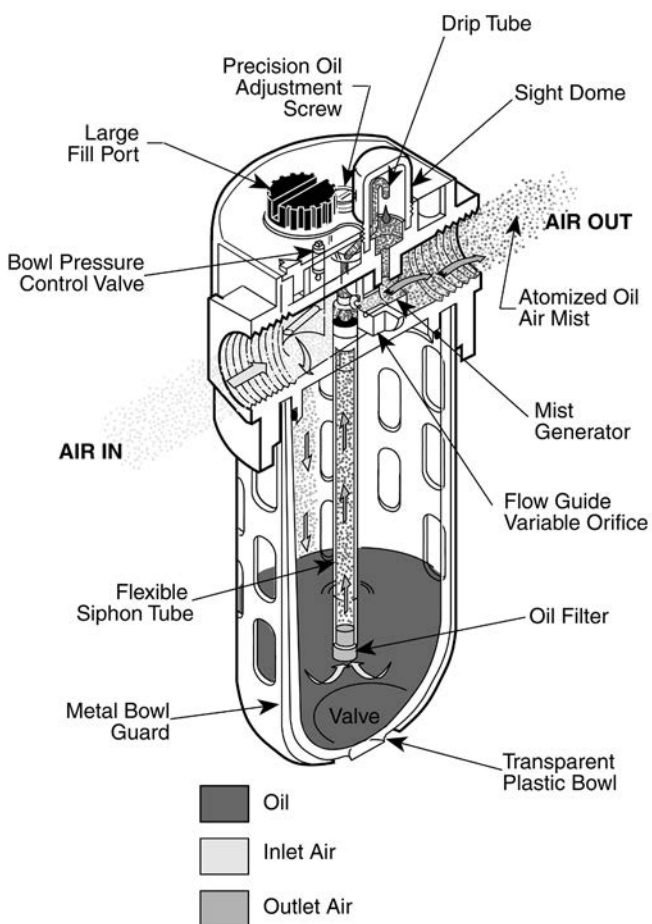

Wilkerson EconOmist® Type Lubricators

Designed so that all the oil flow observed in the sight dome is broken into a mist and delivered via the airflow to the application. This lubricator allows the user to fill or replenish the oil in the bowl without interrupting airflow or bleeding pressure from the system (except miniature models). Once the oil-fill cap is removed, the bowl is depressurized and isolated from line pressure, and the bowl itself can then be removed, if desired, for faster refill. The bowl can also be filled right to the top.

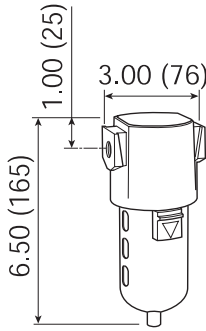

- full view sight dome
- fill under pressure design
- 5 oz. bowl
- maximum operating conditions:
transparent bowl: **150 PSIG** (10.3 bar) and **32-125°F** (0-52°C)
metal bowl: **200 PSIG** (17.2 bar) and **32-150°F** (0-65.5°C)

Size	SCFM	Transparent Bowl Part #	Metal Bowl Part #
1/4"	36.1	L16-02A	L16-02AMB
3/8"	58.5	L16-03A	L16-03AMB
1/2"	64.0	L16-04A	L16-04AMB



transparent bowl with gaurd

Wilkerson EconOmist® Lubricators

Flow Guide®

The elastomer disc-shaped device is located in the throat of all Wilkerson lubricators and automatically maintains a constant ratio of oil flow to airflow regardless of changing rates of airflow. This allows one lubricator to serve several pneumatic components operating together or intermittently.

Type of oil to use:

For all Wilkerson lubricators, use any petroleum-base, non-detergent light weight oil (SAE 10/150SSU) which will readily break up into a mist, i.e., Mobil DTE light or comparable oil. Do not use any synthetic oil or oils containing additives or solvents.

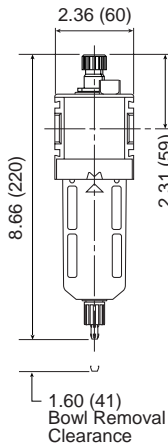

Compact

- high flow capacity
- 4.09 oz. bowl
- can be filled under pressure
- manual drain
- maximum operating conditions:
transparent bowl: **150 PSIG** (10.3 bar) and **32-125°F** (0-52°C)
metal bowl: **200 PSIG** (17.2 bar) and **32-150°F** (0-65.5°C)

Size	SCFM	Transparent Bowl Part #	Metal Bowl Part #
1/4"	88	L18-02A	L18-02AMB
3/8"	90	L18-03A	L18-03AMB
1/2"	96	L18-04A	L18-04AMB



transparent bowl with gaurd

Standard

- quick-disconnect metal bowl guard with integral safety latch
- siphon tube filter provides clean lubricant downstream
- 10 oz. bowl
- can be filled under pressure
- adjustable oil feed
- maximum operating conditions:
transparent bowl: **150 PSIG** (10.3 bar) and **32-125°F** (0-52°C)
metal bowl: **200 PSIG** (13.8 bar) and **32-150°F** (0-65.5°C)

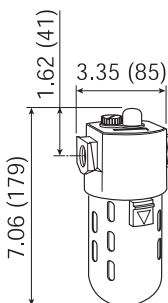

Size	SCFM	Transparent Bowl Part #	Metal Bowl * Part #
1/4"	35	L26-02A	L26-02AMB
3/8"	60	L26-03A	L26-03AMB
1/2"	128	L26-04A	L26-04AMB

* metal bowl has sight gauge with brass petcock drain

See pages 32 - 35 for lubricator accessories.



FRL's are designed for air service only, unless otherwise indicated.

SCFM ratings at 150 PSIG inlet pressure.



with metal bowl

Wilkerson EconOmist® Standard Lubricators



with metal bowl

- high flow capacity
- 6.11 oz. bowl
- can be filled under pressure
- manual drain
- maximum operating conditions:
transparent bowl: **150 PSIG** (10.3 bar) and **32-125°F** (0-52°C)
metal bowl: **250 PSIG** (17 bar) and **32-150°F** (0-65.5°C)

Size	SCFM	Transparent Bowl Part #	Metal Bowl Part #
3/8"	176	L28-03A	L28-03AMB
1/2"	184	L28-04A	L28-04AMB
3/4"	200	L28-06A	L28-06AMB

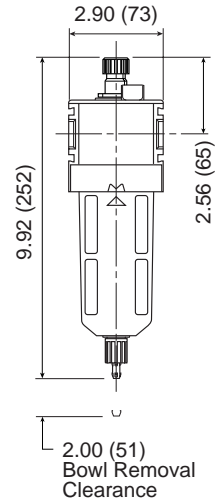

with metal bowl

- 26 oz. bowl
- transparent bowl: no drain
metal bowl: manual brass petcock drain
- can be filled under pressure
- maximum operating conditions:
transparent bowl: **150 PSIG** (10.3 bar) and **32-125°F** (0-52°C)
metal bowl: **200 PSIG** (13.8 bar) and **32-150°F** (0-65.5°C)

Size	SCFM	Transparent Bowl Part #	Metal Bowl Part #
3/4"	196	L30-06A	L30-06AMB
1"	374	L30-08A	L30-08AMB

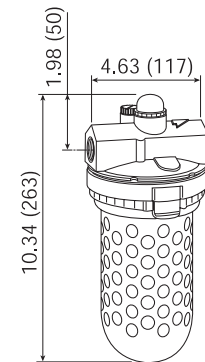

with metal bowl

- quick-disconnect clamp ring for easy bowl removal
- manual bottom drain standard (metal bowl with sight glass only)
- 26 oz. bowl
- full view sight dome
- adjustable oil feed
- maximum operating conditions:
transparent bowl: **150 PSIG** (10.3 bar) and **32-125°F** (0-52°C)
metal bowl: **200 PSIG** (14 bar) and **32-150°F** (0-65.5°C)

Size	SCFM	Transparent Bowl Part #	Metal Bowl Part #
1 1/4"	927	L40-0AA	L40-0AAMB
1 1/2"	927	L40-0BA	L40-0BAMB
2"	1186	L50-0CA	L50-0CAMB

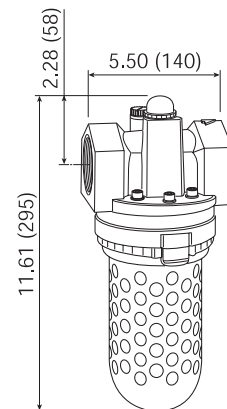

illustration represents L40 series

See pages 32 - 35 for lubricator accessories.



FRL's are designed for air service only, unless otherwise indicated.

SCFM ratings at 150 PSIG inlet pressure.

Wilkerson Compact Combination Units

- models supplied with GC230 gauge

Transparent Bowl with Guard

Size	SCFM	Automatic Drain	Manual Drain
		Part #	Part #
1/4"	36.1	C16-02A	C16-02M
3/8"	58.5	C16-03A	C16-03M
1/2"	64.0	C16-04A	C16-04M

Metal Bowl with Sight Glass

Size	SCFM	Automatic Drain	Manual Drain
		Part #	Part #
1/4"	36.1	C16-02AMB	C16-02MMB
3/8"	58.5	C16-03AMB	C16-03MMB
1/2"	64.0	C16-04AMB	C16-04MMB

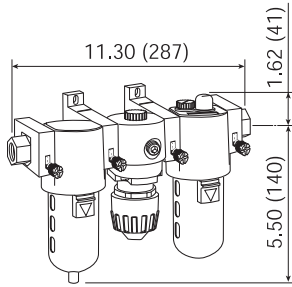

transparent bowl with guard

- models supplied with GC230 gauge

Transparent Bowl with Guard

Size	SCFM	Automatic Drain	Manual Drain
		Part #	Part #
1/4"	110	C18-02A	C18-02M
3/8"	160	C18-03A	C18-03M
1/2"	160	C18-04A	C18-04M

Metal Bowl with Sight Glass

Size	SCFM	Automatic Drain	Manual Drain
		Part #	Part #
1/4"	110	C18-02AMB	C18-02MMB
3/8"	160	C18-03AMB	C18-03MMB
1/2"	160	C18-04AMB	C18-04MMB

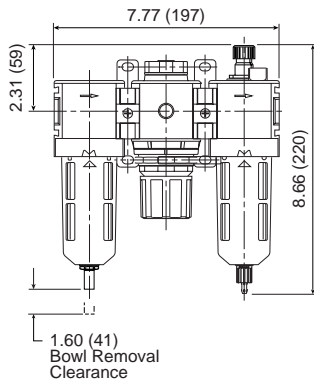

with metal bowl

Wilkerson Standard Combination Units

- models supplied with GC230 gauge

Standard Transparent Bowl with Guard

Size	SCFM	Automatic Drain	Manual Drain
		Part #	Part #
1/4"	35	C26-02A	C26-02M
3/8"	60	C26-03A	C26-03M
1/2"	128	C26-04A	C26-04M

Standard Metal Bowl with Sight Glass

Size	SCFM	Automatic Drain	Manual Drain
		Part #	Part #
1/4"	35	C26-02AMB	C26-02MMB
3/8"	60	C26-03AMB	C26-03MMB
1/2"	128	C26-04AMB	C26-04MMB

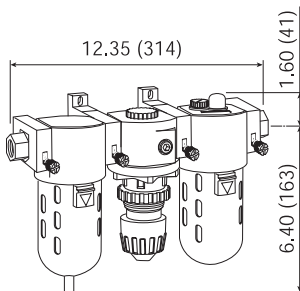

with metal bowl

FRL's are designed for air service only, unless otherwise indicated.



SCFM ratings at 150 PSIG inlet pressure.

Wilkerson Standard Combination Units

- ready to mount assembly
- modern design and appearance
- quick disconnect bowl / bowlguard
- maximum operating conditions:
transparent bowl: **150 PSIG** (10.3 bar) and **32-150°F** (0-65.5°C)
metal bowl: **250 PSIG** (17.2 bar) and **32-150°F** (0-65.5°C)

Transparent Bowl with Guard

Size	SCFM	Automatic Drain Part #	Manual Drain Part #
3/8"	150	C28-03A	C28-03M
1/2"	175	C28-04A	C28-04M
3/4"	175	C28-06A	C28-06M

Metal Bowl with Sight Glass

Size	SCFM	Automatic Drain Part #	Manual Drain Part #
3/8"	150	C28-03AMB	C28-03MMB
1/2"	175	C28-04AMB	C28-04MMB
3/4"	175	C28-06AMB	C28-06MMB

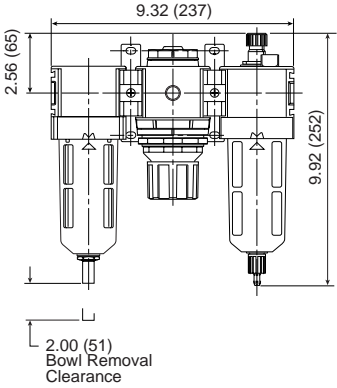

transparent bowl with guard

Wilkerson Jumbo Combination Units

- high flow capacity
- large bowl reservoir
- maximum operating conditions:
transparent bowl: **150 PSIG** (10.3 bar) and **32-125°F** (0-52°C)
metal bowl: **200 PSIG** (13.8 bar) and **32-175°F** (0-80°C)

Transparent Bowl with Guard

Size	SCFM	Automatic Drain Part #	Manual Drain Part #
3/4"	374	C31-06A	C31-06M
1"	374	C31-08A	C31-08M

Metal Bowl with Sight Glass

Size	SCFM	Automatic Drain Part #	Manual Drain Part #
3/4"	374	C31-06AMB	C31-06MMB
1"	374	C31-08AMB	C31-08MMB

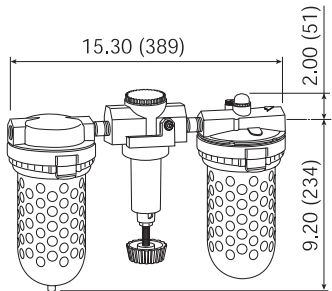

with metal bowl



FRL's are designed for air service only, unless otherwise indicated.

SCFM ratings at 150 PSIG inlet pressure.

Wilkerson Automatic Drain

As liquid contaminants collect in the bowl, they raise a closed-cell cellular float. When the liquid level reaches a given point, the float triggers a mechanism which pilots line pressure against a large area piston or diaphragm which snaps open the drain valve. The contaminants are discharged from the drain orifice at line pressure. As the liquid level falls, the pilot valve closes, line pressure against the piston/diaphragm returns to atmosphere and the drain valve snaps closed. A 1/8" NPT vent orifice is provided at the top of the units for alternate installation as shown below. A 1/8" NPT drain discharge orifice allows the liquid discharge to be piped to a container or sewer.



with metal bowl

- 5 oz. bowl
- fully automatic, float operated
- full 1/2" NPT drain inlet
- quick-disconnect clamp ring for easy bowl removal when servicing
- no electrical connections
- easily installed
- maximum operating conditions:
transparent bowl: **150 PSIG** (10.3 bar) and **32-125°F** (0-52°C)
metal bowl: **200 PSIG** (13.8 bar) and **32-150°F** (0-65.5°C)

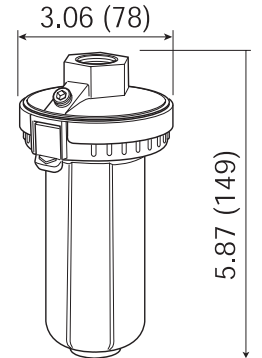

Size	Transparent Bowl Part #	Metal Bowl Part #
1/2"	X02-04	X02-04MB

Automatically drains liquid water and oil from compressed air receivers and systems. Drain valve automatically opens and closes every time the system pressure drops approximately 10 PSI during the compressor cycle. An internal piston design, which utilizes no floats, minimizes the risks associated with drain failures.



- for up to 100 HP compressors
- pressure range: **30 to 200 PSIG** (13.5 bar)
- temperature range: **35°F to 150°F** (32-150°C)
- supplied with 1/4" to 3/8" inlet port screen adapter
- no field adjustments needed

Size	Part #
1/4"	X51-02

Wilkerson Manual In-Line Desiccant Dryer

Manual air dryers are used to remove water vapor from compressed air systems, in applications such as paint spraying, laboratory instruments and small control air systems. Filtration for absorber type dryers is important to protect the desiccant bed from contamination. Cleaner incoming air will result in better performance, longer life and fewer service problems. To regenerate silica gel desiccant, it must be heated to at least 350°F for approximately 3 hours or until color has changed from pink to blue. Allow desiccant to cool to room temperature before pouring back into unit bowl. An after-filter should be placed downstream from the desiccant dryer to ensure solid contaminants such as desiccant dust do not migrate downstream.

- 1.64 lb. bowl
- will dry up to 4400 standard cubic feet of air
- provides atmospheric dew point of -45°F with dry desiccant at **100 PSI** and **70°F**
- silica gel changes from blue to pink to indicate the need to replace or regenerate the desiccant
- slotted bowl guard for visual detection of color change
- desiccant is good for approximately 8 hours at maximum continuous air flow before regeneration is required
- maximum operating conditions:
transparent bowl: **150 PSIG** (10 bar) and **125°F** (52°C)
metal bowl: **150 PSIG** (10 bar) and **150°F** (66°C)
- A standard airline filter and modular coalescing filter should be used as pre-filters when using a desiccant dryer.

SAFETY ALERT

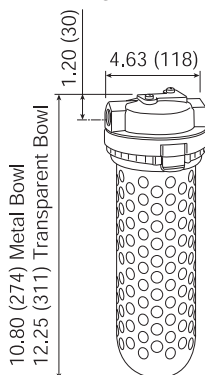

Size	SCFM	Transparent Bowl Part #	Metal Bowl Part #
1/4"	10	X03-02	X03-02MB

See page 26 for silica gel refills.



FRL's are designed for air service only, unless otherwise indicated.

SAFETY ALERT

SCFM ratings at 150 PSIG inlet pressure.

Wilkerson Miniature Filters

- 5 micron element
- .5 oz. bowl
- maximum operating conditions:
transparent bowl: **150 PSIG** (10 bar) and **32-125°F** (0-52°C)
metal bowl: **200 PSIG** (14 bar) and **32-150°F** (0-65.5°C)



transparent bowl

Transparent Bowl

Size	SCFM	Automatic Drain	Manual Drain
		Part #	Part #
1/8"	22	F03-01A	F03-01M
1/4"	24	F03-02A	F03-02M

Metal Bowl

Size	SCFM	Automatic Drain	Manual Drain
		Part #	Part #
1/8"	22	F03-01AMB	F03-01MMB
1/4"	24	F03-02AMB	F03-02MMB

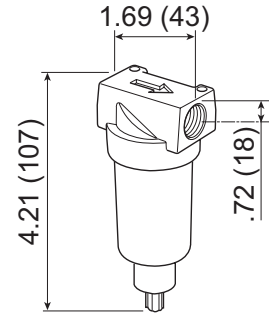

1.60 (41)
Bowl Removal
Clearance

- 5 micron element
- .4 oz. bowl
- maximum operating conditions:
transparent bowl: **150 PSIG** (10 bar) and **32-125°F** (0-52°C)
metal bowl: **250 PSIG** (17 bar) and **32-150°F** (0-65.5°C)



transparent bowl with guard

Transparent Bowl with Guard

Size	SCFM	Automatic Drain	Manual Drain
		Part #	Part #
1/8"	25	F08-01A	F08-01M
1/4"	50	F08-02A	F08-02M

Metal Bowl

Size	SCFM	Automatic Drain	Manual Drain
		Part #	Part #
1/8"	25	F08-01AMB	F08-01MMB
1/4"	50	F08-02AMB	F08-02MMB

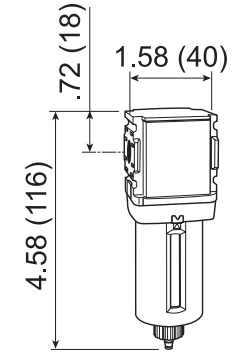

1.31 (33)
Bowl Removal
Clearance

See pages 26 - 29 for filter accessories.

Wilkerson Miniature Regulators

- **2-125 PSI** adjusting range
- balanced valve design
- self-relieving standard
- non-rising push/pull locking adjustment knob
- Two 1/8" NPT gauge ports located on the front and rear faces of the body. These ports may be used as additional regulated ports or for pressure gauges.
- with gauge models supplied with a GC620 gauge
- panel mount nuts sold separately
- maximum operating conditions:
300 PSIG (20.7 bar) and **32-125°F** (0-52°C)

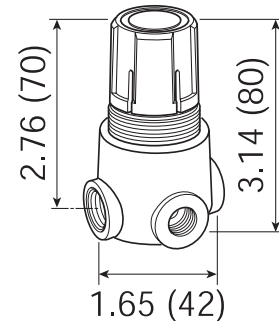

Size	SCFM	With Gauge	Without Gauge
		Part #	Part #
1/8"	13	R03-01RG	R03-01R
1/4"	15	R03-02RG	R03-02R

Wilkerson Miniature Regulators

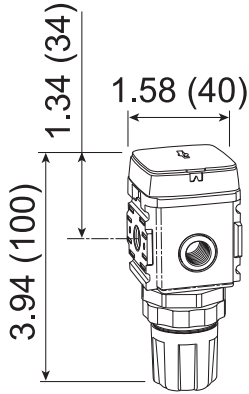

- **0-125 PSI** adjusting range
- balanced valve design
- self-relieving standard
- non-rising push/pull locking adjustment knob
- Two 1/8" NPT gauge ports located on the front and rear faces of the body. These ports may be used as additional regulated ports or for pressure gauges.
- models supplied with gauge come with a 0-160 flush mount style gauge and a one 1/8" NPT gauge port
- with gauge models are supplied with a GC620 gauge
- panel mount nuts sold separately



Size	SCFM	With Gauge Part #	Without Gauge Part #
1/8"	29.2	RB08-01RG	RB08-01R
1/4"	44	RB08-02RG	RB08-02R

Wilkerson Miniature Water Regulators

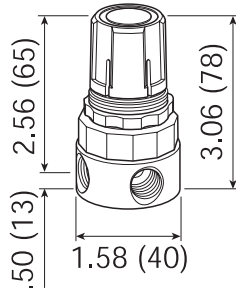

- **2-125 PSI** adjusting range
- water or compressed air service
- brass construction - wetted parts
- non-relieving spring-loaded diaphragm
- two 1/8" NPT gauge ports standard
- panel mount nut included
- with gauge models are supplied with a GC620 gauge
- maximum operating conditions: **300 PSIG (20.7 bar) and 40°F to 125°F (4.4°C to 52°C)**



Size	SCFM	With Gauge Part #	Without Gauge Part #
1/8"	11	RB3-01RG	RB3-01R
1/4"	14	RB3-02RG	RB3-02R

See pages 29 - 31 for regulator accessories.

Wilkerson Miniature Filter / Regulators

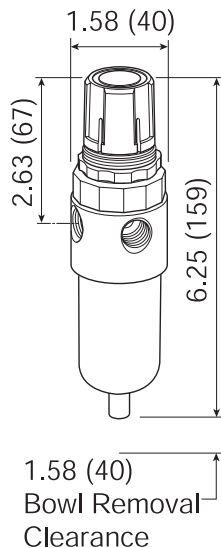

- **2-125 PSI** adjusting range
- 5 micron element
- .5 oz. bowl
- self-relieving
- models supplied with GC620 gauge
- maximum operating conditions: transparent bowl: **125 PSIG (8.6 bar) and 40°F to 125°F (4.4°C to 52°C)**
metal bowl: **300 PSIG (20.7 bar) and 40°F to 125°F (4.4°C to 52°C)**

Transparent Bowl

Size	SCFM	Automatic Drain Part #	Manual Drain Part #
1/8"	13	BB3-01AG	BB3-01MG
1/4"	16	BB3-02AG	BB3-02MG

Metal Bowl

Size	SCFM	Automatic Drain Part #	Manual Drain Part #
1/8"	13	BB3-01AGMB	BB3-01MGMB
1/4"	16	BB3-02AGMB	BB3-02MGMB



transparent bowl

See pages 36 - 37 for filter / regulator accessories.

FRL's are designed for air service only, unless otherwise indicated.



SCFM ratings at 150 PSIG inlet pressure.

Wilkerson Miniature Filter / Regulators

- 0-125 PSI range
- 5 micron element
- .4 oz. bowl
- self-relieving
- models supplied with 0-160 PSI flush mount style gauge
- maximum operating conditions:
transparent bowl: **150 PSIG** (10.3 bar) and **32-125°F** (0-52°C)
metal bowl: **250 PSIG** (17.2 bar) and **32-150°F** (0-65.5°C)



metal bowl

Transparent Bowl with Guard

Size	SCFM	Automatic Drain Part #	Manual Drain Part #
1/8"	28.6	B08-01AG	B08-01MG
1/4"	42.1	B08-02AG	B08-02MG

Metal Bowl

Size	SCFM	Automatic Drain Part #	Manual Drain Part #
1/8"	28.6	B08-01AGMB	B08-01MGMB
1/4"	42.1	B08-02AGMB	B08-02MGMB

See pages 36 - 37 for filter / regulator accessories.

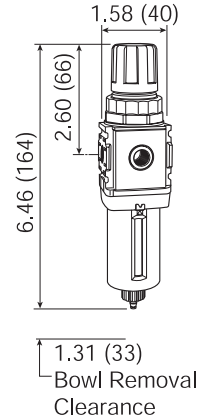

Wilkerson Miniature Lubricators

- 1 oz. bowl
- adjustable oil feed
- full view sight dome
- maximum operating conditions:
transparent bowl: **150 PSIG** (10.3 bar) and **32-125°F** (0-52°C)
metal bowl: **250 PSIG** (17.2 bar) and **32-175°F** (0-80°C)
- Do not fill under pressure. Air supply must be turned off and pressure bled from unit prior to adding oil.

**SAFETY
ALERT**



transparent bowl

Size	SCFM	Transparent Bowl Part #	Metal Bowl Part #
1/8"	20	L03-01A	L03-01AMB
1/4"	20	L03-02A	L03-02AMB

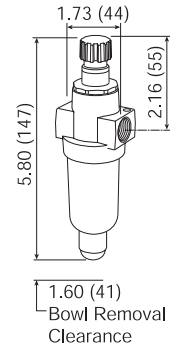

- .6 oz. bowl
- adjustable oil feed
- full view sight dome
- fill under pressure design
- maximum operating conditions:
transparent bowl: **150 PSIG** (10.3 bar) and **32-125°F** (0-52°C)
metal bowl: **250 PSIG** (17.2 bar) and **32-150°F** (0-65.5°C)

Size	SCFM	Transparent Bowl Part #	Metal Bowl Part #
1/8"	23.5	L08-01A	L08-01AMB
1/4"	57.5	L08-02A	L08-02AMB

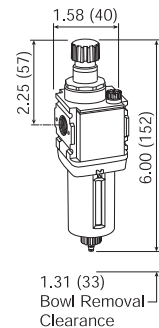

metal bowl

See pages 32 - 35 for lubricator accessories.

**SAFETY
ALERT**

FRL's are designed for air service only, unless otherwise indicated.

SCFM ratings at 150 PSIG inlet pressure.

Wilkerson Miniature Combination Units (Filter, Regulator, Lubricator)

- models supplied with GC620 gauge
- maximum operating conditions:
transparent bowl: **150 PSIG** (10.3 bar) and **32-125°F** (0-52°C)
metal bowl: **250 PSIG** (17.2 bar) and **32-175°F** (0-80°C)

- Lubricator series L03:
- 1 oz. bowl
 - adjustable oil feed
 - full view sight dome
- Included components:
- (2) adapters

- Filter series F03:
- 5 micron element
 - .5 oz. bowl
- Regulator series R03:
- 2-125 PSI adjusting range
 - balanced valve design
 - self-relieving
 - supplied with a GC620 gauge
 - Regulator can be mounted with knob in up or down position.

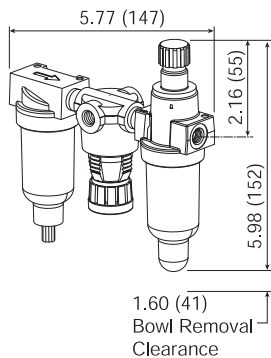

Transparent Bowl with Guard

Size	SCFM	Automatic Drain	Manual Drain
		Part #	Part #
1/8"	20	C03-01A	C03-01M
1/4"	20	C03-02A	C03-02M

Metal Bowl

Size	SCFM	Automatic Drain	Manual Drain
		Part #	Part #
1/8"	20	C03-01AMB	C03-01MMB
1/4"	20	C03-02AMB	C03-02MMB



- models supplied with 0-160 PSI flush mount style gauge
- maximum operating conditions:
transparent bowl: **150 PSIG** (10.3 bar) and **32-125°F** (0-52°C)
metal bowl: **250 PSIG** (17.2 bar) and **32-150°F** (0-65.5°C)

- Lubricator series L08:
- .6 oz. bowl
 - adjustable oil feed
 - full view sight dome
- Included components:
- (2) mounting brackets with joiner set

- Filter series F08:
- 5 micron element
 - .4 oz. bowl
- Regulator series R08:
- 0-125 PSI adjusting range
 - balanced valve design
 - self-relieving
 - supplied with a 0-160 PSI flush mount style gauge

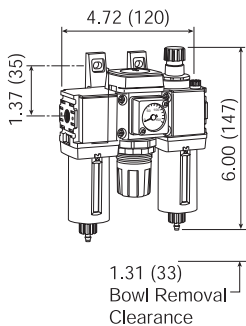

Transparent Bowl with Guard

Size	SCFM	Automatic Drain	Manual Drain
		Part #	Part #
1/8"	29	C08-01A	C08-01M
1/4"	44	C08-02A	C08-02M

Metal Bowl

Size	SCFM	Automatic Drain	Manual Drain
		Part #	Part #
1/8"	29	C08-01AMB	C08-01MMB
1/4"	44	C08-02AMB	C08-02MMB



FRL's are designed for air service only, unless otherwise indicated.



SCFM ratings at 150 PSIG inlet pressure.

Wilkerson Filter Accessories

Elements



FRP-95-115

Used On	Description	Part #
F00	5 micron	FRP-95-235
F03	5 micron	PS403
F08	5 micron	FRP-96-729
F16	5 micron	FRP-95-160
F18	5 micron	FRP-96-639
F26	5 micron	FRP-95-115
F28	5 micron	FRP-96-653
F30	5 micron	FRP-95-209
F35	5 micron	FRP-95-505
F42	5 micron	FRP-95-566



MTP-95-548

Used On	Description	Part #
M26,M16,M30	type B element	MSP-95-989
M16	type C element	MTP-95-548
M26	type C element	MTP-95-549
M30	type C element	MTP-95-551
M35	type C element	MTP-95-502

Gel Refills

Used On	Description	Part #
X03	8 bags of silica gel refill	DRP-85-059

Bowls and Bowl Guards



FRP-95-015

Used On	Description	Part #
F00	plastic bowl with check valve drain	GRP-96-310
F03	plastic bowl with piston drain metal bowl with manual drain	PS408B PS447B
F08	plastic bowl with guard and manual drain metal bowl with manual drain	GRP-96-712 GRP-96-714
F16, M16	plastic bowl and metal bowl guard with flex tip drain plastic bowl and metal bowl guard with auto drain metal bowl with sight glass and manual drain metal bowl with auto drain	FRP-95-014 FRP-95-015 GRP-95-133 FRP-95-950
F18	plastic bowl, bowl guard, manual drain plastic bowl, bowl guard, auto drain metal bowl with sight glass, manual drain metal bowl with sight glass, auto float drain	GRP-96-634 GRP-96-635 GRP-96-636 GRP-96-637
F26, M26	plastic bowl and metal bowl guard with flex tip drain plastic bowl and metal bowl guard with auto drain metal bowl with sight glass and manual drain metal bowl with auto drain	GRP-95-935 GRP-95-948 GRP-95-931 GRP-95-960
F28	plastic bowl with guard, auto drain plastic bowl, bowl guard, manual drain metal bowl, with sight glass, manual drain metal bowl with sight glass, auto float drain	GRP-96-643 GRP-96-642 GRP-96-644 GRP-96-645
F30, M30	plastic bowl and metal bowl guard with manual drain plastic bowl and metal bowl guard with auto drain plastic bowl with flex tip drain metal bowl with sight glass and manual drain metal bowl with auto drain	FRP-95-832 FRP-95-775 FRP-96-315 GRP-95-676 GRP-95-970

Wilkerson Filter Accessories

Auto and Manual Drains

Used On	Description	Part #
F00	manual drain	GRP-96-102
F08	automatic drain	GRP-96-716
F16, F18, F26, F28, F30, F35, M16, M26, M30, M32, M35	automatic drain with fluorocarbon seal	GRP-95-981
F16, F18, F26, F28, F30, M16, M26, M30	automatic float drain with a nitrile seal	GRP-95-973
F16, F18, F26, F28, F30, F35, M16, M26, M30, M35	manual override drain	GRP-96-001
F16, F26, F30, M16, M26, M30	manual pet cock drain	GRP-95-182
F16, F26, F30, M16, M26, M30	manual flex tip drain	FRP-95-610
F18, F28	manual drain	GRP-96-685



GRP-96-001

Sight Glass

Used On	Description	Part #
M16, M26	sight glass kit for metal bowls	GRP-95-079



GRP-95-079

Mounting Brackets and Joiner Sets

Used On	Description	Part #
F03	mounting bracket	PS417B
F08	mounting bracket (T type) with joiner set and port O-ring	GPA-96-737
	mounting bracket (C type)	GPA-97-010
	joiner set and port O-ring	GPA-96-738
F16, M16	mounting bracket (L type)	GPA-95-016
F18	mounting bracket (C type)	GPA-96-604
	mounting bracket (L type)	GPA-96-606
F18, F28	mounting bracket (T type)	GPA-96-602
	mounting bracket (T type) with joiner set and port O-ring	GPA-96-603
	joiner set and port O-ring with nitrile O-ring	GPA-96-601
	joiner set with port O-ring with fluorocarbon O-rings	GPA-96-614
	bracket with joiner set and port O-ring	GPA-96-754
F26, M26	mounting bracket (L type)	GPA-95-946
F28	mounting bracket (C type)	GPA-96-605
	mounting bracket (L type)	GPA-96-607
F30	wall mount, U-bolt pipe clamp	GRP-95-734



GPA-96-737

Modular Sleeve with Wall Mounting Brackets

- Designed for mounting a single unit or combination of units directly to the wall.
- The sleeve and mounting bracket can be ordered assembled from the factory, or just the mounting bracket alone to be used on existing modular sleeves.

Used On	Description	Part #
F16, F26	bracket	GPA-95-968
	sleeve and bracket	GPA-95-969



GPA-95-969

Wilkerson Filter Accessories



GPA-95-292

Modular Sleeve

- Unique modular sleeve design easily and quickly connects one or more units and accessories together without pipe nipples.
- Hand tightening the threaded pin provides a tight seal between the units.

Used On	Description	Part #
F16, F26	modular sleeve	GPA-95-292

End Blocks

- When used with the modular sleeve, end blocks allow a single unit or a combination of units to be piped into the air system in the modular mode.
- allows ease of unit servicing or replacement without disturbing the air line connections
- set of 2 blocks (inlet & outlet)



GPA-97-019

Used On	Description	Part #
F08	end block set, 1/4" NPT end block set, 3/8" NPT	GPA-97-019 GPA-97-020

Modular Blocks

Manifold Block

- allows easy design flexibility
- can be installed after the filter or regulator, providing three additional 1/4" NPT tapped auxiliary ports
- inlet/outlet ports are 1/2" non-tapped
- 1-17/32" width



GPA-95-919

End Block

- When used with the modular sleeve, end blocks allow a single unit or a combination of units to be piped into the air system in the modular mode.
- allows ease of unit servicing or replacement without disturbing the air line connections
- set of 2 blocks (inlet & outlet)



GPA-95-321

Used On	Description	Part #
F16, M16, F26, M26	manifold block, three 1/4" NPT auxiliary ports end block, 1/4" NPT end block, 3/8" NPT end block, 1/2" NPT end block, 3/4" NPT end block, 1" NPT	GPA-95-919 GPA-95-223 GPA-95-224 GPA-95-225 GPA-95-320 GPA-95-321
F18, F28	end block, 1/4" NPT end block, 3/8" NPT end block, 1/2" NPT end block, 3/4" NPT end block, G1/4" end block, G3/8" end block, G1/2" end block, G3/4"	GPA-96-610 GPA-96-611 GPA-96-612 GPA-96-613 GPA-96-620 GPA-96-621 GPA-96-622 GPA-96-623

Modular Adapters

- When used with the modular sleeve, adapter inserts allow a single unit or a combination of units to be piped into the air system in the modular mode.
- allows ease of unit servicing or replacement without disturbing the air line connections
- set of 2 blocks

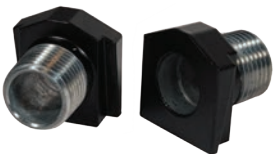

GPA-95-037

Used On	Description	Part #
F16, M16, F26, M26	1/4" NPT pipe adapter 3/8" NPT pipe adapter 1/2" NPT pipe adapter	GPA-95-035 GPA-95-036 GPA-95-037

Wilkerson Filter Accessories

Modular Shut-Off Valves

- can be installed immediately upstream of a single unit or combination of units
- secured to the unit with a modular sleeve or modular sleeve wall mounting bracket
- ball-type valve operates with a 1/4 turn from open to shut position
- useful for isolating and depressurizing a downstream unit requiring maintenance or replacement
- can be locked in the open position
- left to right flow



GPA-95-098

Used On	Description	Part #
F16, F26	1/4" NPT safety lock-out valve	GPA-95-096
	3/8" NPT safety lock-out valve	GPA-95-097
	1/2" NPT safety lock-out valve	GPA-95-098

Differential Pressure Indicators

- used to replace damaged indicators on filters and modular coalescing filters
- Pressure loss changes color of indicator window from green to red.



DP2-01-000

Used On	Description	Part #
M16, M26, M30, M32	indicator	DP2-01-000
F35, M35	indicator	DP2-01-001

Wilkerson Regulator Accessories

Replacement Springs

Used On	Description	Part #
R16	0-50 PSI spring	RRP-95-222
	0-125 PSI spring	RRP-95-224
R18	0-125 PSI spring	RRP-96-661
R26	0-60 PSI spring	RRP-95-962
	0-125 PSI spring	GRP-95-225
R28	0-125 PSI spring	RRP-96-165



RRP-95-222

Gauges

- for units originally purchased with flush mounted gauge

Used On	Description	Part #
R08	0-160 PSI, flush mount design	GRP-96-719



GRP-96-719

Tamper Resistant Kits

Used On	Description	Part #
R00, R08	ring style tamper resistant kit	RPA-96-735
R16, R26	ring style tamper resistant kit	RPA-95-006
R18	ring style tamper resistant kit	RRP-96-671
R28	ring style tamper resistant kit	RRP-96-672



RPA-95-006

Wilkerson Regulator Accessories

Repair Kits



RRP-95-952

Used On	Description	Part #
R16	self-relieving repair kit	RRP-95-131
R18	relieving diaphragm assembly	RRP-96-656
R26	self-relieving repair kit	RRP-95-952
R28	relieving diaphragm assembly	RRP-96-986
R30	valve assembly: valve, spring, bottom plug O-ring	RRP-95-159
R40	valve assembly: valve, spring, retaining ring, O-rings	RRP-95-161

Mounting Brackets and Joiner Sets



GPA-96-737

Used On	Description	Part #
R00, RB3	mounting bracket (L type) and nut	GRP-95-747
R03	mounting bracket	PS417B
R08	mounting bracket (T type) with joiner set	GPA-96-737
	mounting bracket (C type)	GPA-97-010
	mounting bracket (L type)	GRP-96-739
	joiner set with port O-ring	GPA-96-738
R16	mounting bracket (L type) and nut	GPA-95-011
R16, R21, R26, R30, R40	bracket, wall mount, gauge port adapter with 1/4" NPT	RRP-95-590
R26	mounting bracket (C type) and nut	RPA-95-947
R30	wall mount, U-bolt pipe clamp	GRP-95-734

Modular Sleeve with Wall Mounting Brackets



GPA-95-969

- Designed for mounting a single unit or combination of units directly to the wall.
- The sleeve and mounting bracket can be ordered assembled from the factory, or just the mounting bracket alone to be used on existing modular sleeves.

Used On	Description	Part #
R16, R26	bracket sleeve and bracket	GPA-95-968 GPA-95-969

Modular Sleeve



GPA-95-292

- Unique modular sleeve design easily and quickly connects one or more units and accessories together without pipe nipples.
- Hand tightening the threaded pin provides a tight seal between the units.

Used On	Description	Part #
R16, R26	modular sleeve	GPA-95-292

End Blocks



GPA-97-019

- When used with the modular sleeve, end blocks allow a single unit or a combination of units to be piped into the air system in the modular mode.
- allows ease of unit servicing or replacement without disturbing the air line connections
- set of 2 blocks (inlet & outlet)

Used On	Description	Part #
R08	end block set, 1/4" NPT	GPA-97-019
	end block set, 3/8" NPT	GPA-97-020

Wilkerson Regulator Accessories

Modular Blocks

Manifold Block

- allows easy design flexibility
- can be installed after the filter or regulator, providing three additional 1/4" NPT tapped auxiliary ports
- inlet/outlet ports are 1/2" non-tapped
- 1-17/32" width

End Block

- When used with the modular sleeve, end blocks allow a single unit or a combination of units to be piped into the air system in the modular mode.
- allows ease of unit servicing or replacement without disturbing the air line connections
- set of 2 blocks (inlet & outlet)



GPA-95-919



GPA-95-321

Used On	Description	Part #
R16, R26	manifold block, three 1/4" NPT auxiliary ports	GPA-95-919
	end block, 1/4" NPT	GPA-95-223
	end block, 3/8" NPT	GPA-95-224
	end block, 1/2" NPT	GPA-95-225
	end block, 3/4" NPT	GPA-95-320
	end block, 1" NPT	GPA-95-321
R18, R28	end block, 1/4" NPT	GPA-96-610
	end block, 3/8" NPT	GPA-96-611
	end block, 1/2" NPT	GPA-96-612
	end block, 3/4" NPT	GPA-96-613
	end block, G1/4"	GPA-96-620
	end block, G3/8"	GPA-96-621
	end block, G1/2"	GPA-96-622
	end block, G3/4"	GPA-96-623



GPA-96-610

Modular Adapters

- When used with the modular sleeve, adapter inserts allow a single unit or a combination of units to be piped into the air system in the modular mode.
- allows ease of unit servicing or replacement without disturbing the air line connections
- set of 2 blocks

Used On	Description	Part #
R16, R26	1/4" NPT pipe adapter	GPA-95-035
	3/8" NPT pipe adapter	GPA-95-036
	1/2" NPT pipe adapter	GPA-95-037



GPA-95-037

Modular Shut-Off Valves

- can be installed immediately upstream of a single unit or combination of units
- secured to the unit with a modular sleeve or modular sleeve wall mounting bracket
- ball-type valve operates with a 1/4 turn from open to shut position
- useful for isolating and depressurizing a downstream unit requiring maintenance or replacement
- can be locked in the open position
- left to right flow

Used On	Description	Part #
R16, R26	1/4" NPT safety lock-out valve	GPA-95-096
	3/8" NPT safety lock-out valve	GPA-95-097
	1/2" NPT safety lock-out valve	GPA-95-098



GPA-95-098

Wilkerson Lubricator Accessories

Modular Sleeve with Wall Mounting Brackets

- Designed for mounting a single unit or combination of units directly to the wall.
- The sleeve and mounting bracket can be ordered assembled from the factory, or just the mounting bracket alone to be used on existing modular sleeves.

Used On	Description	Part #
L16, L26	bracket	GPA-95-968
	sleeve and bracket	GPA-95-969



GPA-95-969

Modular Sleeve

- Unique modular sleeve design easily and quickly connects one or more units and accessories together without pipe nipples.
- Hand tightening the threaded pin provides a tight seal between the units.

Used On	Description	Part #
L16, L26	modular sleeve	GPA-95-292



GPA-95-292

End Blocks

- When used with the modular sleeve, end blocks allow a single unit or a combination of units to be piped into the air system in the modular mode.
- allows ease of unit servicing or replacement without disturbing the air line connections
- set of 2 blocks (inlet & outlet)

Used On	Description	Part #
L08	end block set, 1/4" NPT	GPA-97-019
	end block set, 3/8" NPT	GPA-97-020



GPA-97-019

Modular Blocks

Manifold Block

- allows easy design flexibility
- can be installed after the filter or regulator, providing three additional 1/4" NPT tapped auxiliary ports
- inlet/outlet ports are 1/2" non-tapped
- 1-17/32" width

End Block

- When used with the modular sleeve, end blocks allow a single unit or a combination of units to be piped into the air system in the modular mode.
- allows ease of unit servicing or replacement without disturbing the air line connections
- set of 2 blocks (inlet & outlet)

Used On	Description	Part #
L16, L26	manifold block, three 1/4" NPT auxiliary ports	GPA-95-919
	end block, 1/4" NPT	GPA-95-223
	end block, 3/8" NPT	GPA-95-224
	end block, 1/2" NPT	GPA-95-225
	end block, 3/4" NPT	GPA-95-320
	end block, 1" NPT	GPA-95-321
L18, L28	end block, 1/4" NPT	GPA-96-610
	end block, 3/8" NPT	GPA-96-611
	end block, 1/2" NPT	GPA-96-612
	end block, 3/4" NPT	GPA-96-613
	end block, G1/4"	GPA-96-620
	end block, G3/8"	GPA-96-621
	end block, G1/2"	GPA-96-622
	end block, G3/4"	GPA-96-623



GPA-95-919



GPA-95-321



GPA-96-610

Wilkerson Lubricator Accessories

Modular Adapters

- When used with the modular sleeve, adapter inserts allow a single unit or a combination of units to be piped into the air system in the modular mode.
- allows ease of unit servicing or replacement without disturbing the air line connections
- set of 2 blocks

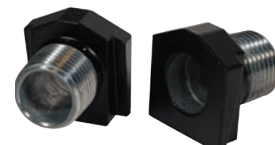

GPA-95-037

Used On	Description	Part #
L16, L26	1/4" NPT pipe adapter	GPA-95-035
	3/8" NPT pipe adapter	GPA-95-036
	1/2" NPT pipe adapter	GPA-95-037

Modular Shut-Off Valves

- can be installed immediately upstream of a single unit or combination of units
- secured to the unit with a modular sleeve or modular sleeve wall mounting bracket
- ball-type valve operates with a 1/4 turn from open to shut position
- useful for isolating and depressurizing a downstream unit requiring maintenance or replacement
- can be locked in the open position
- left to right flow



GPA-95-098

Used On	Description	Part #
L16, L26	1/4" NPT safety lock-out valve	GPA-95-096
	3/8" NPT safety lock-out valve	GPA-95-097
	1/2" NPT safety lock-out valve	GPA-95-098

Drains

Used On	Description	Part #
L16, L26, L40, L50	manual drain	GRP-96-102
L16, L26, L30, L40, L50	manual pet cock drain for use with metal bowls	GRP-95-182
L18, L28	manual drain	GRP-96-685



GRP-96-685

Sight Domes and Fill Plugs

Used On	Description	Part #
L00, L08, L16, L26	sight dome kit: dome and O-ring	LRP-95-239
L08	fill plug kit: fill plug and O-ring	LRP-96-730
L08, L18, L28	sight dome kit (old style -08)	LRP-96-710
L16, L26	sight glass kit for metal bowls	GRP-95-079
L16, L26, L30	fill plug kit: fill plug and O-ring	LRP-95-253
L18, L28	sight dome assembly (new style)	LRP-96-310
L30, L40, L50	sight dome kit: dome and O-ring	LRP-95-249
L40, L50	fill plug kit: fill plug and O-ring	LRP-95-250



LRP-95-249

Wilkerson Lubricator Accessories

Bowls and Bowl Guards



GRP-95-019

Used On	Description	Part #
L00	metal bowl with manual drain	PS447B
L03	plastic bowl with no drain	PS421
L08	metal bowl with manual drain	GRP-96-714
	plastic bowl with guard and manual drain	LRP-96-736
L16	metal bowl with sight glass and manual drain	GRP-95-133
	plastic bowl, bowl guard, manual drain	GRP-95-019
	plastic bowl with no drain	LRP-96-937
L18	metal bowl with sight glass, manual drain	GRP-96-636
	plastic bowl, bowl guard, manual drain	LRP-96-701
L26	metal bowl with sight glass and manual drain	GRP-95-931
	plastic bowl with no drain	LRP-96-938
L28	metal bowl with sight glass, manual drain	GRP-96-644
	plastic bowl, bowl guard, manual drain	LRP-96-702
L30, L40	metal bowl with sight glass and manual drain	GRP-95-676
L30, L40, L50	plastic bowl with no drain	LRP-96-940

Mounting Brackets



GPA-96-737

Used On	Description	Part #
L03	mounting bracket	PS419
L08	mounting bracket (T type) with joiner set and port O-ring	GPA-96-737
	mounting bracket (C type)	GPA-97-010
	joiner set and port O-ring	GPA-96-738
L16	mounting bracket (L type)	GPA-95-016
L18	mounting bracket (C type)	GPA-96-604
	mounting bracket (L type)	GPA-96-606
L18, L28	mounting bracket (T type)	GPA-96-602
	mounting bracket (T type) with joiner set and port O-ring	GPA-96-603
	joiner set with port O-ring	GPA-96-614
	bracket with joiner set and port O-ring	GPA-96-754
L26	mounting bracket (L type)	GPA-95-946
L28	mounting bracket (C type)	GPA-96-605
	mounting bracket (L type)	GPA-96-607
L30	wall mount, U-bolt pipe clamp	GRP-95-734

Wilkerson Combination Unit with Protective Frame



Provides downstream air preparation with protective frame and includes components:

- C31-08AMB 1" FRL with metal bowls and auto drain filter
- BBLV100 1" brass ball valve and AM12 air king on inlet port
- BBV100DTW 2-way ball valve installed between regulator and lubricator provides option for non-lubricated air
- heavy duty frame protects air prep components
- operating conditions:
 maximum pressure: **250 PSIG**
 temperature range: **40°F to 150°F**
 SCFM: 320

1" FRL with protective frame

Part #

C31-08FRAME

Wilkerson Filter/Regulator Accessories

Elements

Used On	Description	Part #
B08	5 micron	FRP-96-729
CB6	5 micron	FRP-95-160
B18	5 micron	FRP-96-639
B28	5 micron	FRP-96-653



FRP-96-729

Bowls and Bowl Guards

Used On	Description	Part #
B08	plastic bowl with guard and manual drain	GRP-96-712
	metal bowl with manual drain	GRP-96-714
CB6	plastic bowl and metal bowl guard with flex tip drain	FRP-95-014
	plastic bowl and metal bowl guard with auto drain	FRP-95-015
	metal bowl with auto drain	FRP-95-950
B18	plastic bowl, bowl guard, manual drain	GRP-96-634
	plastic bowl, bowl guard, auto drain	GRP-96-635
	metal bowl with sight glass, manual drain	GRP-96-636
	metal bowl with sight glass, auto float drain	GRP-96-637
B28	plastic bowl with guard, auto drain	GRP-96-643
	plastic bowl, bowl guard, manual drain	GRP-96-642
	metal bowl, with sight glass, manual drain	GRP-96-644
	metal bowl with sight glass, auto float drain	GRP-96-645



GRP-96-636

Auto and Manual Drains

Used On	Description	Part #
B08	automatic drain	GRP-96-716
CB6	manual pet cock drain for use with metal bowls	GRP-95-182
	manual flex tip drain	FRP-95-610
CB6, B18, B28	automatic drain with fluorocarbon seal	GRP-95-981
	automatic float drain with a nitrile seal	GRP-95-973
	manual override drain	GRP-96-001
B18, B28	manual drain	GRP-96-685



GRP-96-001

Accessories

Used On	Description	Part #
CB6	kit for metal bowl	GRP-95-079

Replacement Springs

Used On	Description	Part #
CB6	0-50 PSI spring	RRP-95-222
	0-125 PSI spring	RRP-95-224
B18	0-125 PSI spring	RRP-96-661
B28	0-125 PSI spring	RRP-96-165



RRP-95-222

Wilkerson Filter/Regulator Accessories

Tamper Resistant Kits



Used On	Description	Part #
B08	ring style tamper resistant kit	RPA-96-735
B18	ring style tamper resistant kit	RRP-96-671
B28	ring style tamper resistant kit	RRP-96-672

Repair Kits



Used On	Description	Part #
B18	diaphragm assembly, relieving	RRP-96-656
B28	diaphragm assembly, relieving	RRP-96-986

Mounting Brackets and Joiner Sets



GPA-96-737

Used On	Description	Part #
R08	mounting bracket (T type) with joiner set mounting bracket (C type) mounting bracket (L type) joiner set with port O-ring	GPA-96-737 GPA-97-010 GRP-96-739 GPA-96-738
CB6	mounting bracket (L type) and nut bracket, wall mount, gauge port adapter with 1/4" NPT	GPA-95-011 RRP-95-590
B18	mounting bracket (C type) mounting bracket (L type)	GPA-96-604 GPA-96-606
B18, B28	mounting bracket (T type) mounting bracket (T type) with joiner set joiner set with port O-ring bracket with joiner set and port O-ring joiner set	GPA-96-602 GPA-96-603 GPA-96-614 GPA-96-754 GPA-96-601
B28	mounting bracket (C type) mounting bracket (L type)	GPA-96-605 GPA-96-607

Wilkerson FRL Display

Increase your sales with this heavy duty, point-of-purchase Dixon FRL Display, designed to highlight the features and benefits of a modular Filter-Regulator-Lubricator Combination Unit for air line services. The display is perfect for your "Will Call" or showroom sales area.



The display features:

- FRL combination unit with standard metal bowl with sight glass
- manual drain
- modular mounting clamps
- pipe adapters

Note: assembly is required.

Part #

WILK26DISPLAY

Dixon	Wilkerson	Dixon	Wilkerson	Dixon	Wilkerson	Dixon	Wilkerson
B08-01AG	B08-01-FRG0	C18-02M	C18-02-FKG0	F08-01AMB	F08-01-SS00	L08-02AMB	L08-02-KL00
B08-01MG	B08-01-FKG0	C18-03M	C18-03-FKG0	F08-02AMB	F08-02-SS00	L16-02A	L16-02-000
B08-01AGMB	B08-01-LSG0	C18-04M	C18-04-FKG0	F08-01MMB	F08-01-SL00	L16-03A	L16-03-000
B08-01MGMB	B08-01-LLG0	C18-02AMB	C18-02-FHG0	F08-02MMB	F08-02-SL00	L16-04A	L16-04-000
B08-02AG	B08-02-FRG0	C18-03AMB	C18-03-FHG0	F16-02A	F16-02-F00	L16-02AMB	L16-02-G00
B08-02MG	B08-02-FKG0	C18-04AMB	C18-04-FHG0	F16-03A	F16-03-F00	L16-03AMB	L16-03-G00
B08-02AGMB	B08-02-LSG0	C18-02MMB	C18-02-FLG0	F16-04A	F16-04-F00	L16-04AMB	L16-04-G00
B08-02MGMB	B08-02-LLG0	C18-03MMB	C18-03-FLG0	F16-02M	F16-02-000	L18-02A	L18-02-KK00
B18-02A	B18-02FGG0	C18-04MMB	C18-04-FLG0	F16-03M	F16-03-000	L18-03A	L18-03-KK00
B18-03A	B18-03FGG0	C26-02A	C26-02-F00	F16-04M	F16-04-000	L18-04A	L18-04-KK00
B18-04A	B18-04-FGG0	C26-02M	C26-02-000	F16-02AMB	F16-02-FG0	L18-02AMB	L18-02-KL00
B18-02M	B18-02-FK00	C26-02AMB	C26-02-FG0	F16-03AMB	F16-03-FG0	L18-03AMB	L18-03-KL00
B18-03M	B18-03-FK00	C26-02MMB	C26-02-G00	F16-04AMB	F16-04-FG0	L18-04AMB	L18-04-KL000
B18-04M	B18-04-FK00	C26-03A	C26-03-F00	F16-02MMB	F16-02-G00	L26-02A	L26-02-000
B18-02AMB	B18-02-GH00	C26-03M	C26-03-000	F16-03MMB	F16-03-G00	L26-03A	L26-03-000
B18-03AMB	B18-03-GH00	C26-03AMB	C26-03-FG0	F16-04MMB	F16-04-G00	L26-04A	L26-04-000
B18-04AMB	B18-04-GH00	C26-03MMB	C26-03-G00	F18-02A	F18-02-SG00	L26-02AMB	L26-02-G00
B18-02MMB	B18-02-GL00	C26-04A	C26-04-F00	F18-03A	F18-03-SG00	L26-03AMB	L26-03-G00
B18-03MMB	B18-03-GL00	C26-04M	C26-04-000	F18-04A	F18-04-SG00	L26-04AMB	L26-04-G00
B18-04MMB	B18-04-GL00	C26-04AMB	C26-04-FG0	F18-02M	F18-02-SK00	L28-03A	L28-03-KK00
B28-03A	B28-03-FG00	C26-04MMB	C26-04-G00	F18-03M	F18-03-SK00	L28-04A	L28-04-KK00
B28-04A	B28-04-FG00	C28-03A	C28-03-FGG0	F18-04M	F18-04-SK00	L28-06A	L28-06-KK00
B28-06A	B28-06-FG00	C28-04A	C28-04-FGG0	F18-02AMB	F18-02-SH00	L28-03AMB	L28-03-KL00
B28-03M	B28-03-FK00	C28-06A	C28-06-FGG0	F18-03AMB	F18-03-SH00	L28-04AMB	L28-04-KL00
B28-04M	B28-04-FK00	C28-03M	C28-03-FKG0	F18-04AMB	F18-04-SH00	L28-06AMB	L28-06-KL00
B28-06M	B28-06-FK00	C28-04M	C28-04-FKG0	F18-02MMB	F18-02-SL00	L30-06A	L30-06-000
B28-03AMB	B28-03-GH00	C28-06M	C28-06-FKG0	F18-03MMB	F18-03-SL00	L30-08A	L30-08-000
B28-04AMB	B28-04-GH00	C28-03AMB	C28-03-FHG0	F18-04MMB	F18-04-SL00	L30-06AMB	L30-06-G00
B28-06AMB	B28-06-GH00	C28-04AMB	C28-04-FHG0	F26-02A	F26-02-F00	L30-08AMB	L30-08-G00
B28-03MMB	B28-03-GL00	C28-06AMB	C28-06-FHG0	F26-03A	F26-03-F00	L40-0AA	L40-0A-000
B28-04MMB	B28-04-GL00	C28-03MMB	C28-03-FLG0	F26-04A	F26-04-F00	L40-0BA	L40-0B-000
B28-06MMB	B28-06-GL00	C28-04MMB	C28-04-FLG0	F26-02M	F26-02-000	L40-0CA	L40-0C-000
BB3-01AG	BB3-01-FRGO	C28-06MMB	C28-06-FLG0	F26-03M	F26-03-000	L40-0AAMB	L40-0A-G00
BB3-02AG	BB3-02-FRGO	C31-06A	C31-06-F00	F26-04M	F26-04-000	L40-0BAMB	L40-0B-G00
BB3-01AGMB	BB3-01-FSG0	C31-06M	C31-06-000	F26-02AMB	F26-02-FG0	L40-0CAMB	L40-0C-G00
BB3-02AGMB	BB3-02-FSG0	C31-06AMB	C31-06-FG0	F26-03AMB	F26-03-FG0	L50-0CAMB	L50-0C-G00
BB3-01MG	BB3-01-FKG0	C31-06MMB	C31-06-G0	F26-04AMB	F26-04-FG0	M16-02A	M16-02-F00
BB3-01MGMB	BB3-01-FLG0	C31-08A	C31-08-F00	F26-02MMB	F26-02-G00	M16-03A	M16-03-F00
BB3-02MG	BB3-02-FKG0	C31-08M	C31-08-000	F26-03MMB	F26-03-G00	M16-04A	M16-04-F00
BB3-02MGMB	BB3-02-FLG0	C31-08AMB	C31-08-FG0	F26-04MMB	F26-04-G00	M16-02M	M16-02-000
C03-01A	C03-01-D000	C31-08MMB	C31-08-G00	F28-03A	F28-03-SG00	M16-03M	M16-03-000
C03-01M	C03-01-0000	CB6-02AG	CB6-02-F00	F28-04A	F28-04-SG00	M16-04M	M16-04-000
C03-02A	C03-02-D000	CB6-02AGMB	CB6-02-FG0	F28-06A	F28-06-SG00	M26-02A	M26-02-F00
C03-02M	C03-02-0000	CB6-02MG	CB6-02-000	F28-03M	F28-03-SK00	M26-03A	M26-03-F00
C03-01AMB	C03-01-DM00	CB6-02MGMB	CB6-02-G00	F28-04M	F28-04-SK00	M26-04A	M26-04-F00
C03-01MMB	C03-01-M000	CB6-02AMB	CB6-02-FM0	F28-06M	F28-06-SK00	M26-02M	M26-02-000
C03-02AMB	C03-02-DM00	CB6-02MMB	CB6-02-G00	F28-03AMB	F28-03-SH00	M26-03M	M26-03-000
C03-02MMB	C03-02-M000	CB6-03AG	CB6-03-F00	F28-04AMB	F28-04-SH00	M26-04M	M26-04-000
C08-01A	C08-01-FRG0	CB6-03AGMB	CB6-03-FG0	F28-06AMB	F28-06-SH00	M30-04A	M30-04-F00
C08-01M	C08-01-FKG0	CB6-03MG	CB6-03-000	F28-03MMB	F28-03-SL00	M30-06A	M30-06-F00
C08-02A	C08-02-FRG0	CB6-03AMB	CB6-03-FM0	F28-04MMB	F28-04-SL00	M30-08A	M30-08-F00
C08-02M	C08-02-FKG0	CB6-03MGMB	CB6-03-G00	F28-06MMB	F28-06-SL00	M32-0AAMB	M32-0A-F00
C08-01AMB	C08-01-LSG0	CB6-03MMB	CB6-03-G00	F30-06A	F30-06-F00	M35-0BAMB	M35-0B-F00
C08-01MMB	C08-01-LLG0	CB6-04AG	CB6-04-F00	F30-08A	F30-08-F00	M35-0CAMB	M35-0C-F00
C08-02AMB	C08-02-LSG0	CB6-04AGMB	CB6-04-FG0	F30-06M	F30-06-000	R03-01R	R03-01-000
C08-02MMB	C08-02-LLG0	CB6-04MG	CB6-04-000	F30-08M	F30-08-000	R03-02R	R03-02-000
C16-02A	C16-02-F00	CB6-04MGMB	CB6-04-G00	F30-06AMB	F30-06-FG0	R03-01RG	R03-01-G00
C16-02M	C16-02-000	CB6-04AMB	CB6-04-FM0	F30-08AMB	F30-08-FG0	R03-02RG	R03-02-G00
C16-02AMB	C16-02-FG0	CB6-04MMB	CB6-04-G00	F30-06MMB	F30-06-G00	R08-01RG	R08-01-F0G0
C16-02MMB	C16-02-G00	F03-01A	F03-01-D00	F30-08MMB	F30-08-G00	R08-01R	R08-01-F000
C16-03A	C16-03-F00	F03-02A	F03-02-D00	F35-0BAMB	F35-0B-F00	R08-02RG	R08-02-F0G0
C16-03M	C16-03-000	F03-01AMB	F03-01-DM0	F35-0CAMB	F35-0C-F00	R08-02R	R08-02-F000
C16-03AMB	C16-03-FG0	F03-02AMB	F03-02-DM0	F35-0BMMB	F35-0B-000	R16-02R	R16-02-000
C16-03MMB	C16-03-G00	F03-01M	F03-01-000	F35-0CMMB	F35-0C-000	R16-02RG	R16-02-G00
C16-04A	C16-04-F00	F03-02M	F03-02-000	L03-01A	L03-01-000	R16-02RH	R16-02-H00
C16-04M	C16-04-000	F03-01MMB	F03-01-M00	L03-02A	L03-02-000	R16-02RHG	R16-02-GH0
C16-04AMB	C16-04-FG0	F03-02MMB	F03-02-M00	L03-01AMB	L03-01-M00	R16-03RG	R16-03-G00
C16-04MMB	C16-04-G00	F08-01A	F08-01-SR00	L03-02AMB	L03-02-M00	R16-03R	R16-03-000
C18-02A	C18-02-FGG0	F08-02A	F08-02-SR00	L08-01A	L08-01-KK00	R16-03RH	R16-03-H00
C18-03A	C18-03-FGG0	F08-01M	F08-01-SK00	L08-02A	L08-02-KK00	R16-03RHG	R16-03-GH0
C18-04A	C18-04-FGG0	F08-02M	F08-02-SK00	L08-01AMB	L08-01-KL00	R16-04RG	R16-04-G00

Dixon	Wilkerson
R16-04RH	R16-04-H00
R16-04RHG	R16-04-GH0
R16-04R	R16-04-000
R18-02R	R18-02-F0G0
R18-03R	R18-03-F0G0
R18-04R	R18-04-F000
R26-02RG	R26-02-G00
R26-02RH	R26-02-H00
R26-02RHG	R26-02-GH0
R26-02R	R26-02-000
R26-03RG	R26-03-G00
R26-03RH	R26-03-H00
R26-03RHG	R26-03-GH0
R26-03R	R26-03-000
R26-04RG	R26-04-H00
R26-04RH	R26-04-G00
R26-04RHG	R26-04-GH0
R26-04R	R26-04-000
R28-03R	R28-03-F000
R28-04R	R28-04-F000
R28-06R	R28-06-F000
R30-06RG	R30-06-G00
R30-06RH	R30-06-H00
R30-06RHG	R30-06-GH0
R30-06R	R30-06-000
R30-08RG	R30-08-G00
R30-08RH	R30-08-H00
R30-08RHG	R30-08-GH0
R30-08R	R30-08-000
R30-0ARG	R30-0A-G00
R30-0ARH	R30-0A-H00
R30-0ARHG	R30-0A-GH0
R30-0AR	R30-0A-000
R40-0BRG	R30-0B-G00
R40-0BRH	R40-0B-H00
R40-0BRHG	R40-0B-GH0
R40-0BR	R40-0B-000
R40-0CRG	R40-0C-G00
R40-0CRH	R40-0C-H00
R40-0CRHG	R40-0C-GH0
R40-0CR	R40-0C-000
RB3-01R	RB-01-R000
RB3-01RG	RB-01-R0G0
RB3-02R	RB3-02-R000
RB3-02RG	RB3-02-R0G0
X02-04	X02-04-000
X02-04MB	X02-04-M00
X03-02	X03-02-000
X03-02MB	X03-02-M00
X51-02	X51-02-000

Safety Recommendations

Air Prep Units:

Air preparation units (FRL's) must be properly maintained if reasonable service life is to be expected. The proper function of these units is essential to safety, performance and the extension of service life of the pneumatic tools involved. Filters must be properly drained, and the filter elements must be cleaned or replaced as necessary. The regulators should be periodically checked for pressure accuracy. Lubricators must be checked to ensure there is always lubricant available in the reservoir of the air tool. Be sure to use only lubricants that are recommended for this service, and never consider a substitution without contacting the manufacturer of the unit. See page 16 for additional information on the use of lubricants.

FRL Brackets:

Consideration should be given to properly supporting pneumatic preparation units (FRL's in an air system).

Unsupported preparation units can lead to leaks within the piping system that may promote safety and efficiency problems. Mounting brackets are offered on page 27.

General Safety

- Use Dixon couplings, retention devices and accessory products only for their intended service.
- All recommendations of the Hose Manufacturer, and the Coupling Manufacturer, must be employed with regards to Size, Temperature, Application, Media, and Pressure when selecting the components for a hose assembly.
- All finished hose assemblies should be tested in accordance with the Rubber Manufacturers Association recommendations.
- All hose assemblies should be thoroughly inspected prior to each use to ensure they are undamaged, and properly coupled.
- Use safety clips on couplings, and King Safety Cables on assemblies where required by the manufacturer, as well as State and Federal regulations. (OSHA regulations may be viewed in full on the OSHA website, www.osha.gov.)
- Under no circumstances should the assembly working pressure or working temperature exceed the working pressure or working temperature of the lowest rated component (coupling, clamp, ferrule, or hose).
- Call Dixon (800.355.1991) for advice on couplings, retention devices, and accessories for your application.

Dixon is recognized as the premier manufacturer and supplier of hose fittings and accessories spanning a wide range of industrial uses. Dixon's range includes products for food, dairy processing, beverage and brewery, mobile tankers, mining, construction, chemical processing, petroleum, oilfields, refining and manufacturing.

dixonvalve.com • *Customer Service:* 877.963.4966

Dixon Valve

800 High Street, Chestertown, MD 21620

Fax: 800.283.4966



YouTube



Dixon
Customer Service

