

**PART#: N12604808**  
**(DATA SUBJECT TO CHANGE WITHOUT NOTICE)**

THIS DRAWING IS PROPERTY OF HUBBELL INC. WIEGMANN ALL INFORMATION IS PROPRIETARY AND NOT TO BE DUPLICATED

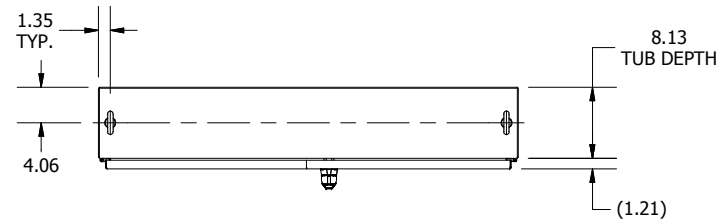

**TOP VIEW**

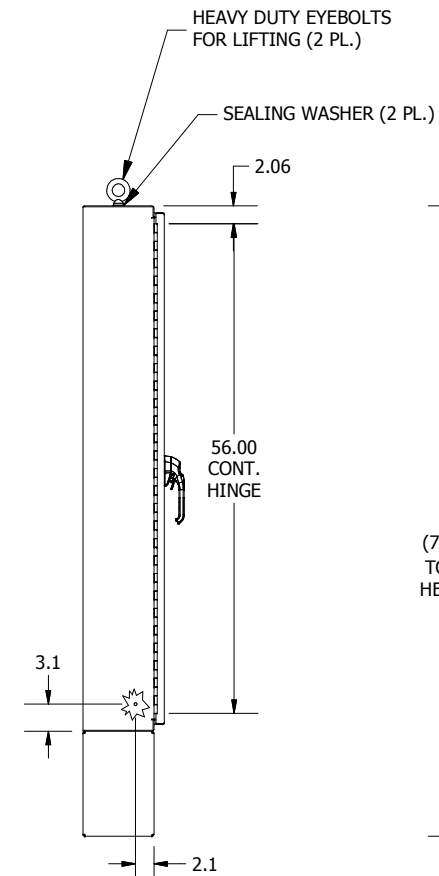

**LEFT SIDE VIEW**

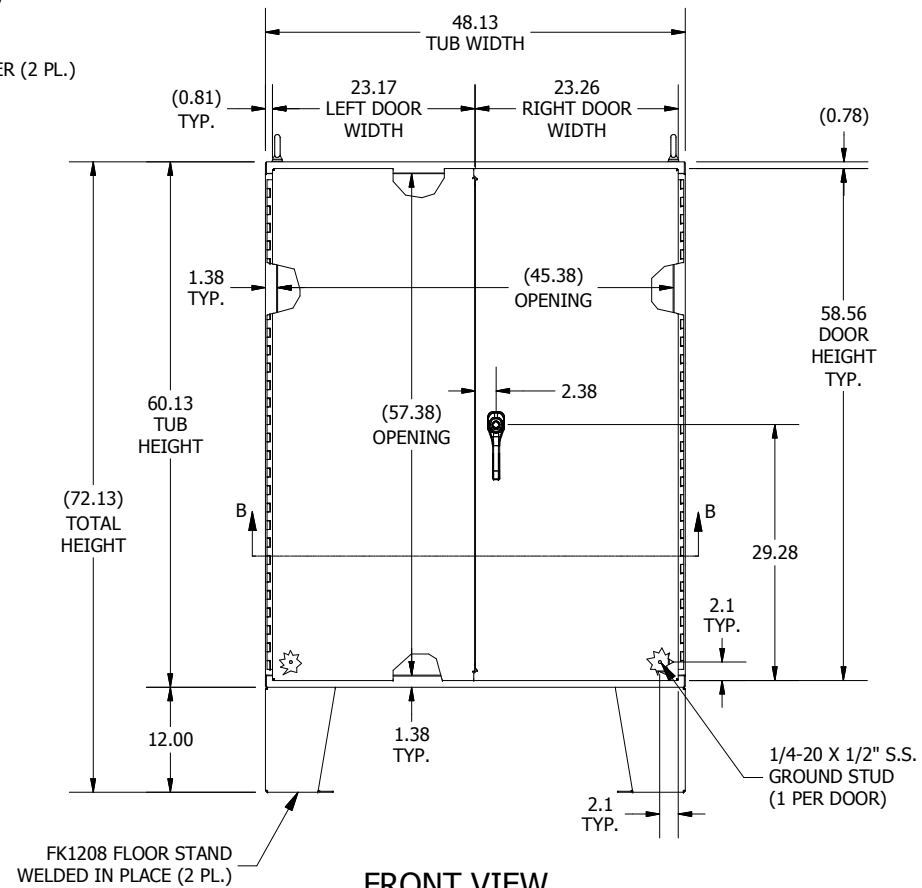

**FRONT VIEW**

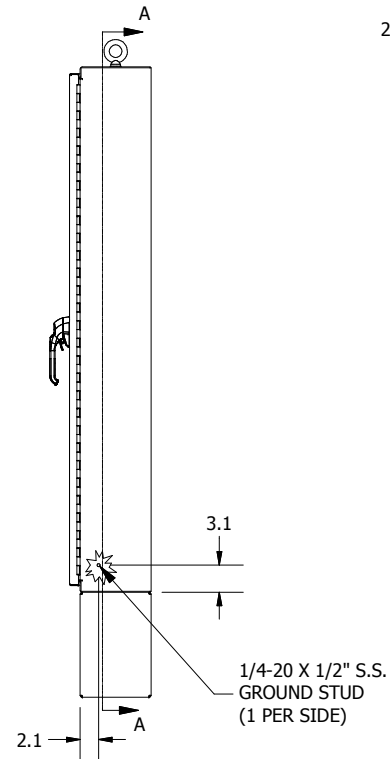

**RIGHT SIDE VIEW**

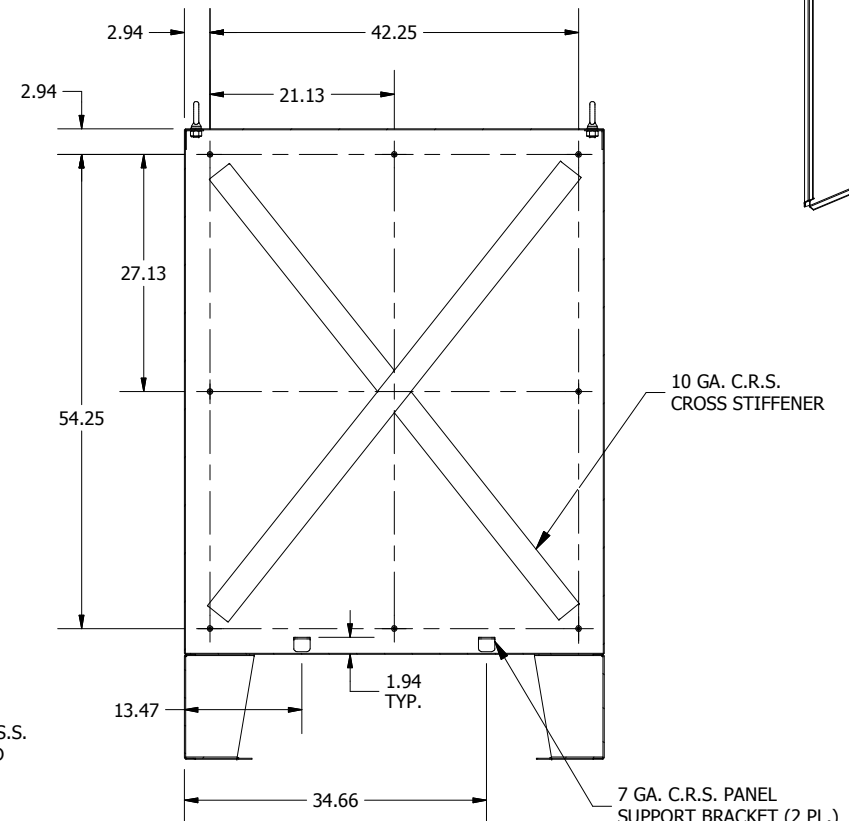

**SECTION A-A  
(INSIDE BACK OF ENCL.)**

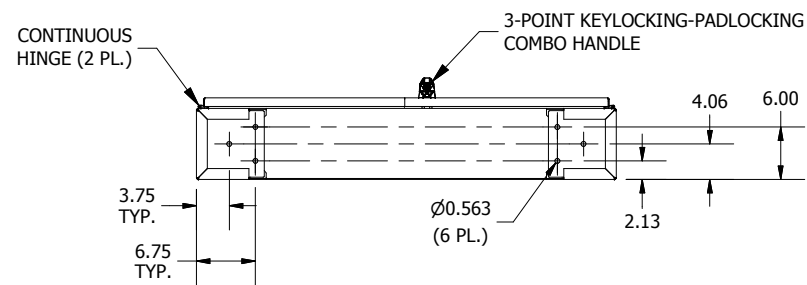

**BOTTOM VIEW**

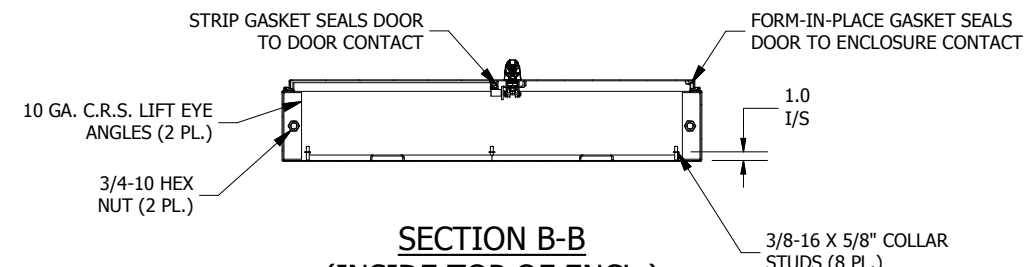

**SECTION B-B  
(INSIDE TOP OF ENCL.)**

