

**TOP VIEW**

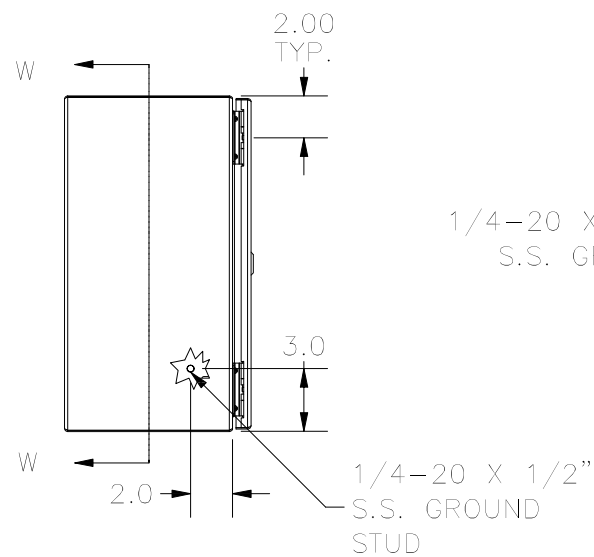

**LEFT SIDE VIEW**

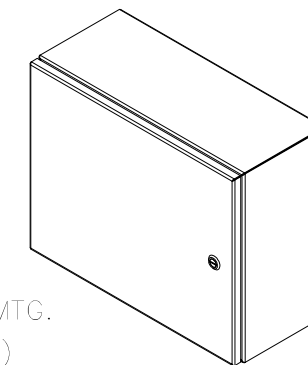
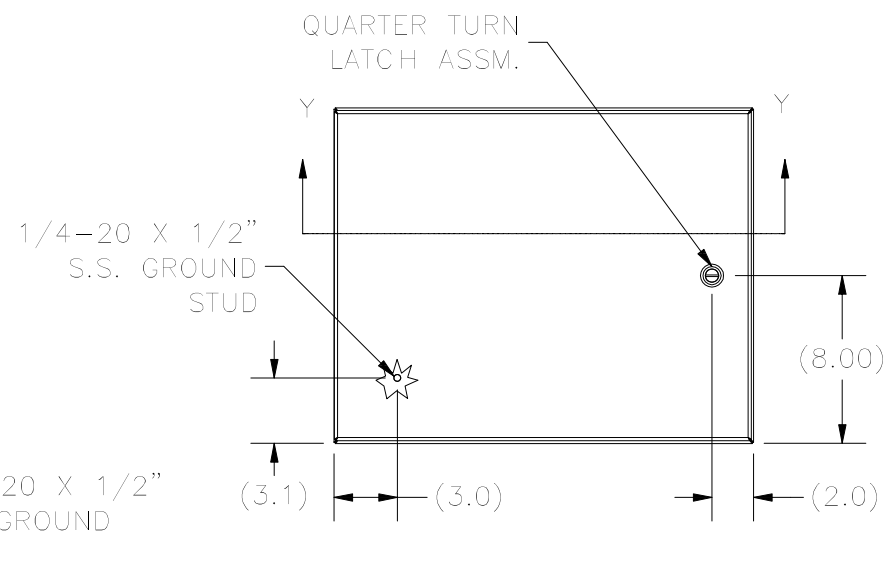

**FRONT VIEW**

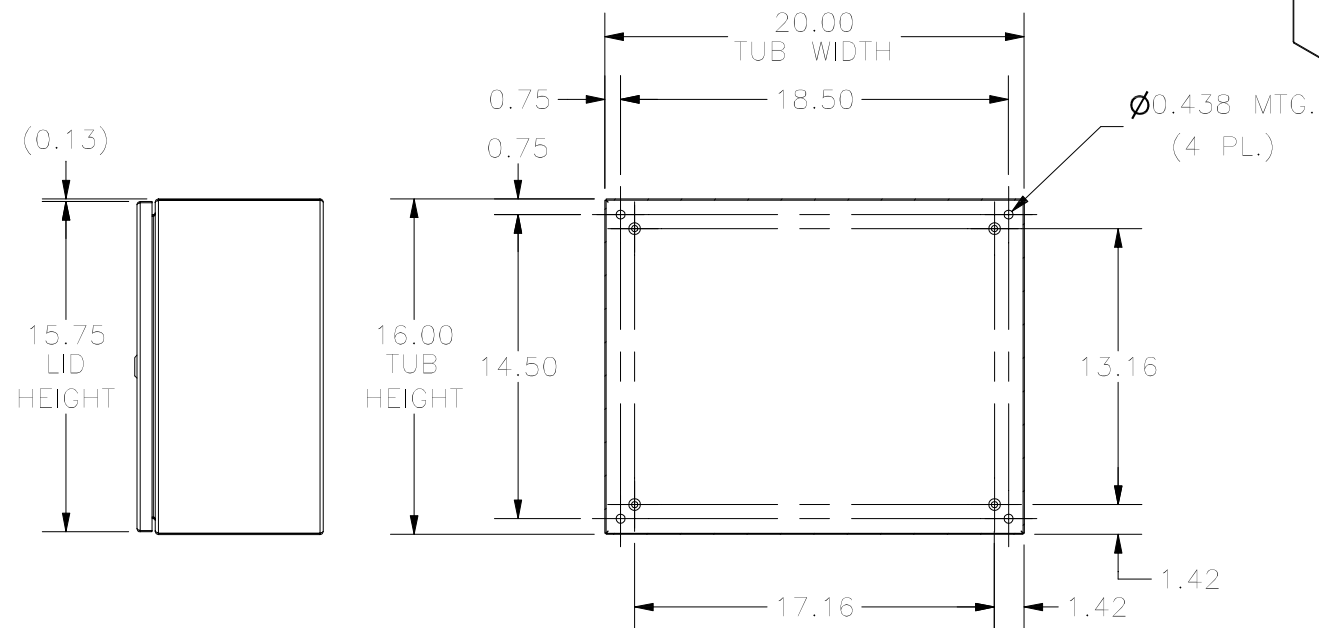

**RIGHT SIDE VIEW**

**SECTION W-W  
(INSIDE BACK OF ENCLOSURE)**

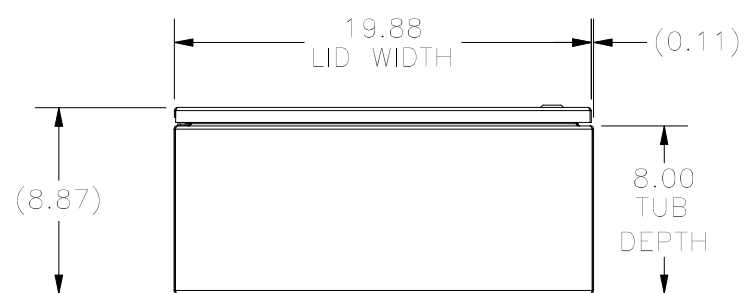

**BOTTOM VIEW**

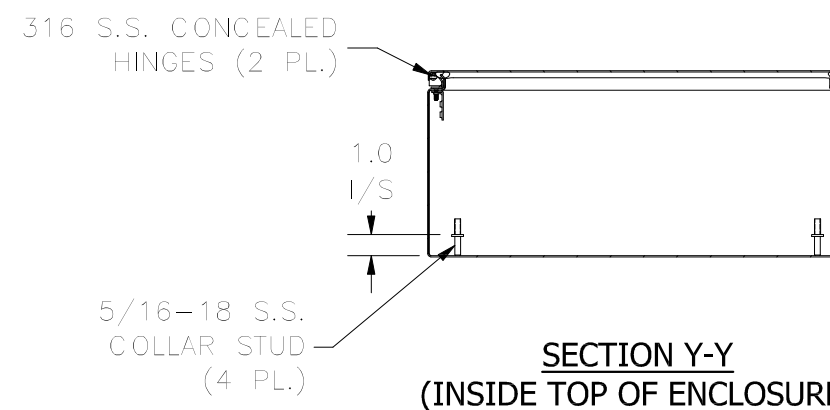

**SECTION Y-Y  
(INSIDE TOP OF ENCLOSURE)**

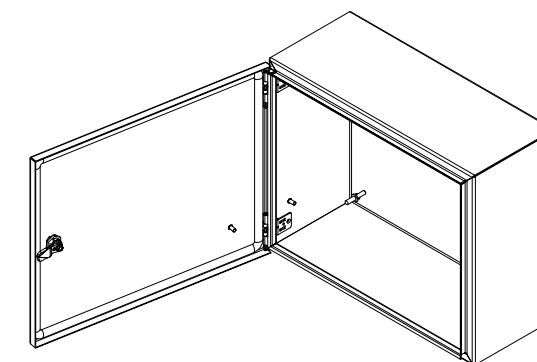

PART #: N412162008SSAC  
(DATA SUBJECT TO CHANGE WITHOUT NOTICE.)

THIS DRAWING IS PROPERTY OF HUBBELL INC. WIEGMANN  
ALL INFORMATION IS PROPRIETARY AND NOT TO BE DUPLICATED