

**TOP VIEW**

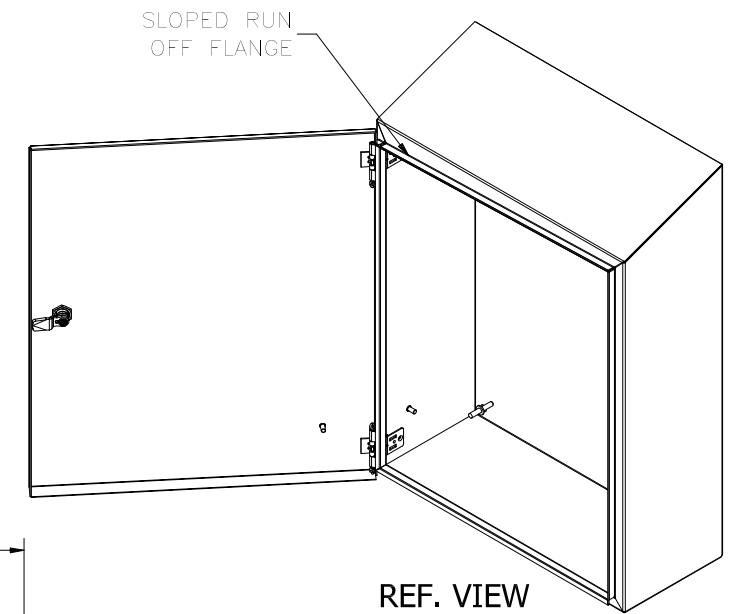

**REF. VIEW (DOOR OPEN)**

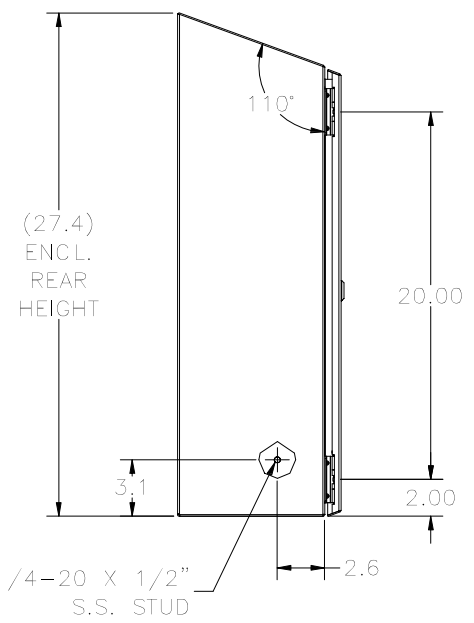

**LEFT SIDE VIEW**

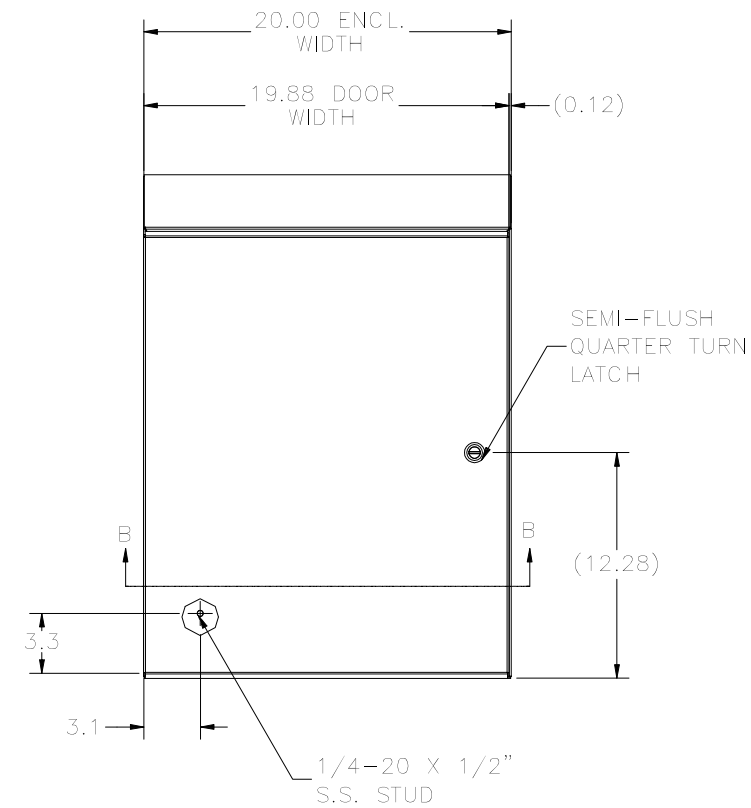

**FRONT VIEW**

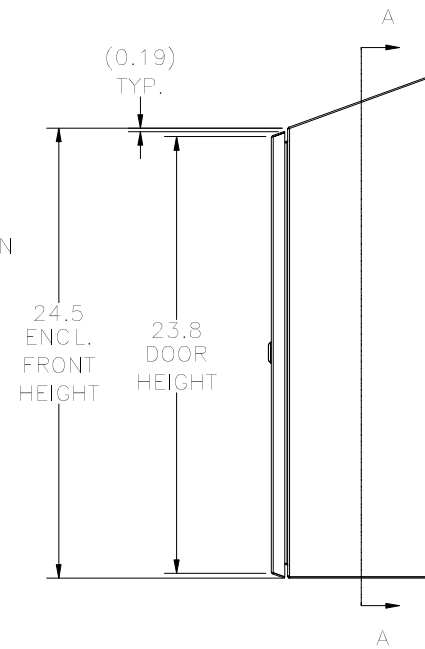

**RIGHT SIDE VIEW**

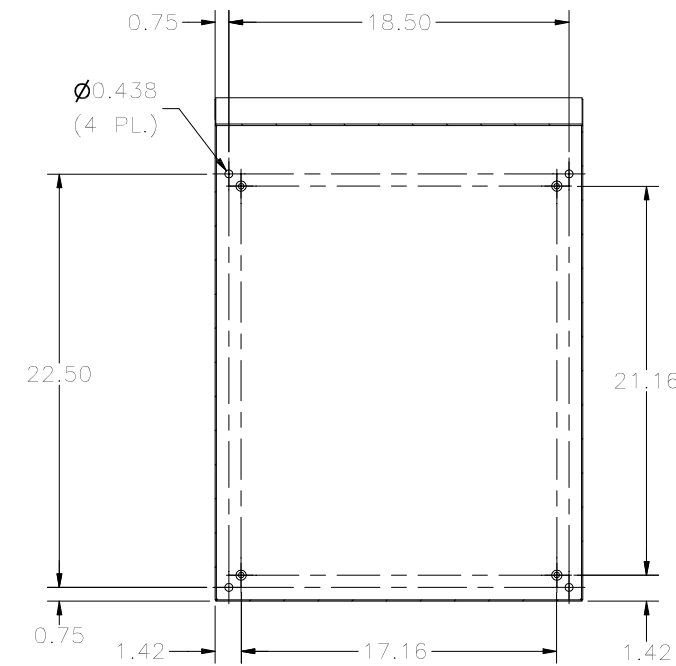

**SECTION A-A VIEW (INSIDE BACK OF ENCL.)**

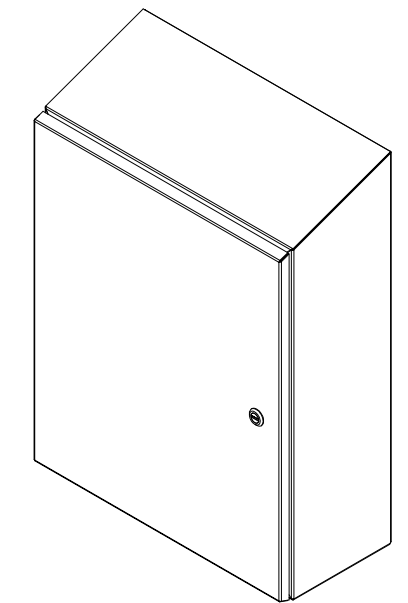

**REF. VIEW (DOOR CLOSED)**

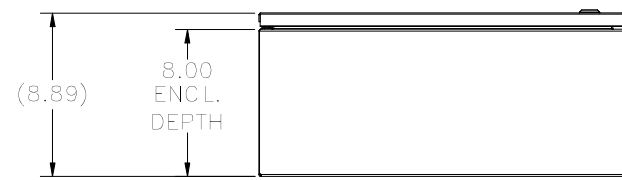

**BOTTOM VIEW**

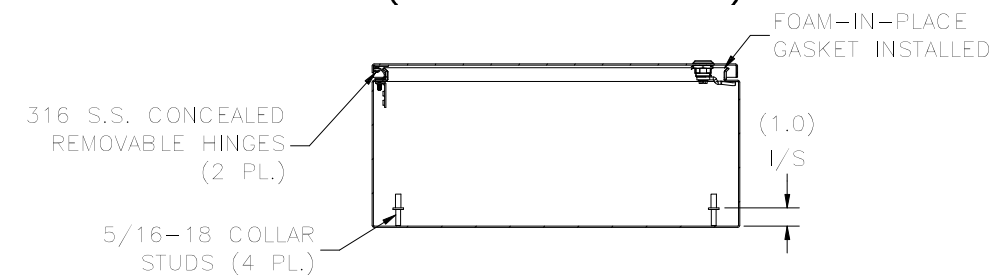

**SECTION B-B VIEW (INSIDE TOP OF ENCL.)**

PART#: N412242008C ST  
 (DATA SUBJECT TO CHANGE WITHOUT NOTICE)

THIS DRAWING IS PROPERTY OF HUBBELL INC. WIEGMANN  
 ALL INFORMATION IS PROPRIETARY AND NOT TO BE DUPLICATED