

TOP VIEW

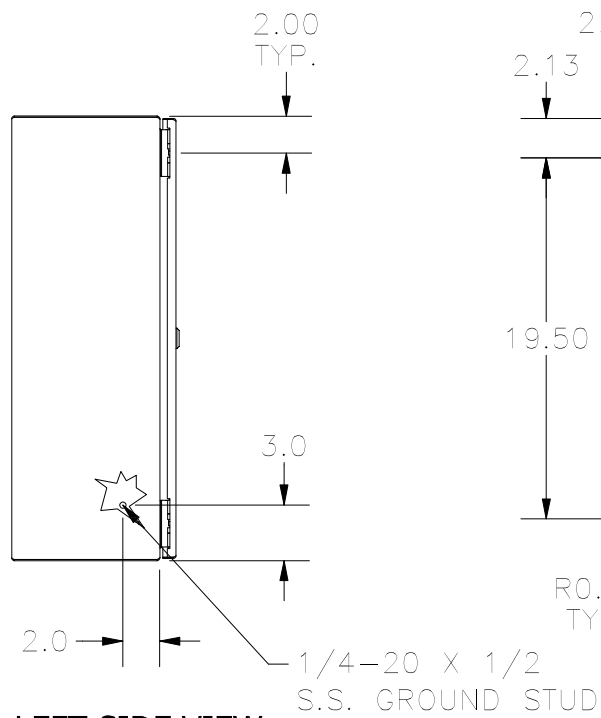

LEFT SIDE VIEW

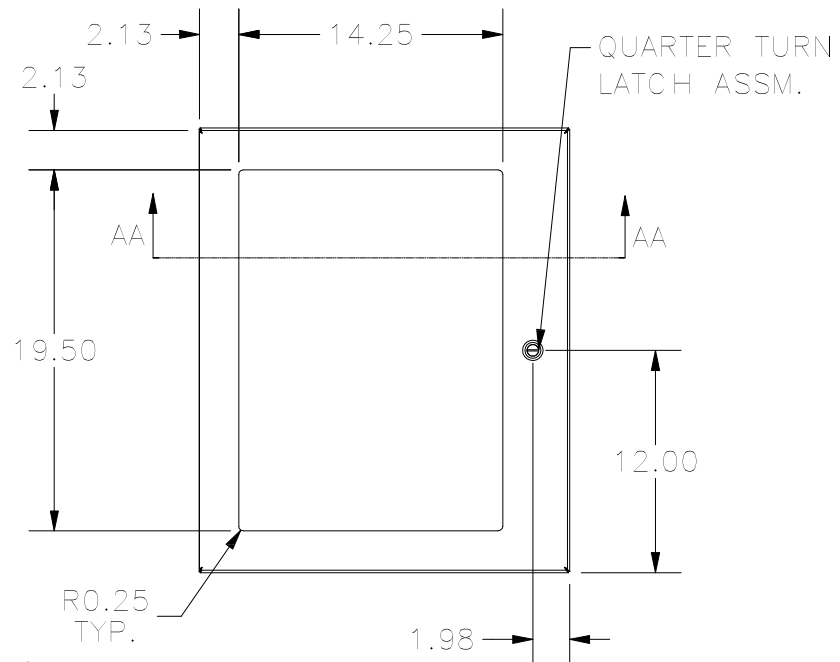

FRONT VIEW

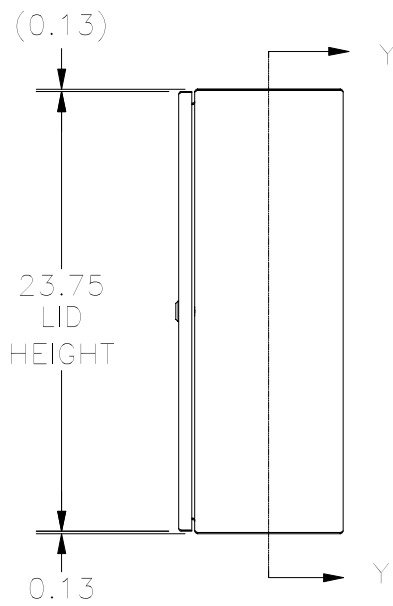

RIGHT SIDE VIEW

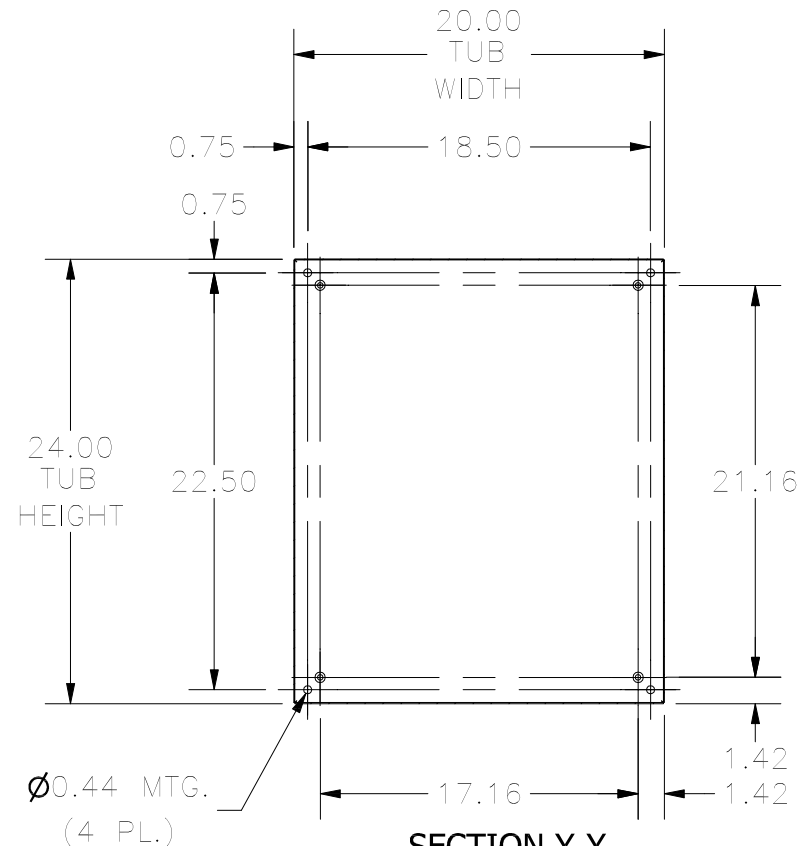

**SECTION Y-Y
(INSIDE BACK OF ENCLOSURE)**

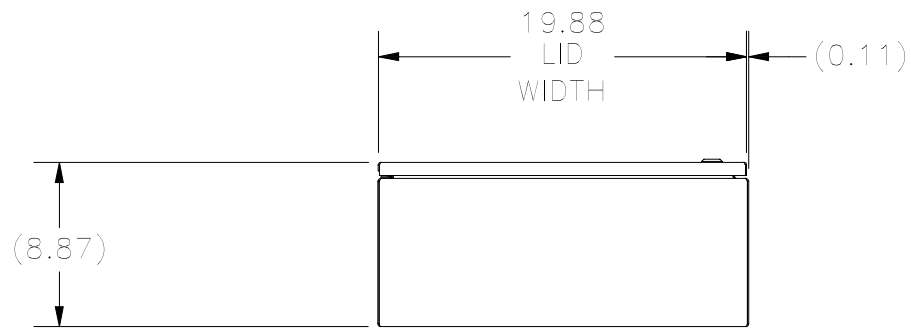

BOTTOM VIEW

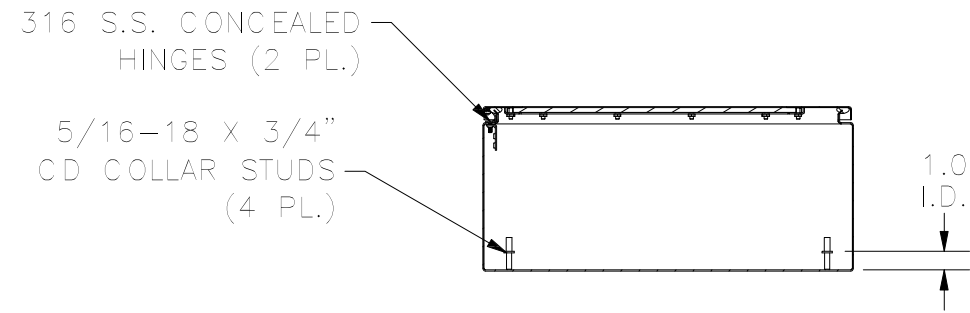

**SECTION AA-AA
(INSIDE TOP OF ENCLOSURE)**

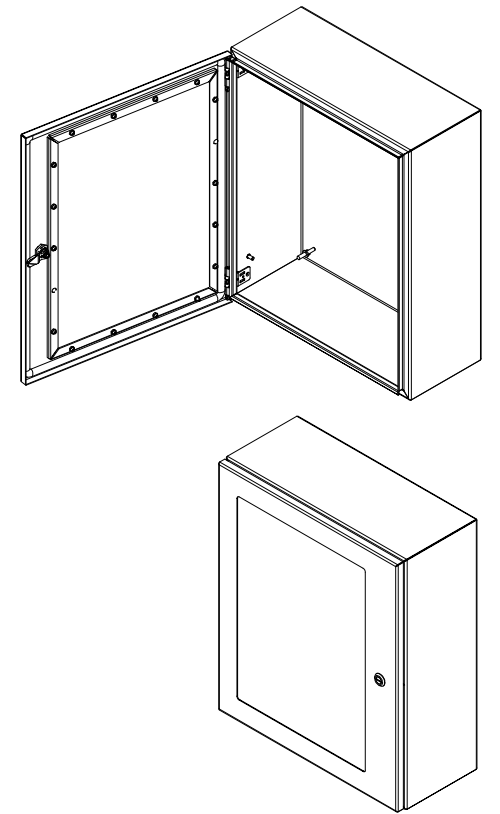

PART #: N412242008WSSC
(DATA SUBJECT TO CHANGE WITHOUT NOTICE.)

THIS DRAWING IS PROPERTY OF HUBBELL INC. WIEGMANN
ALL INFORMATION IS PROPRIETARY AND NOT TO BE DUPLICATED