

TOP VIEW

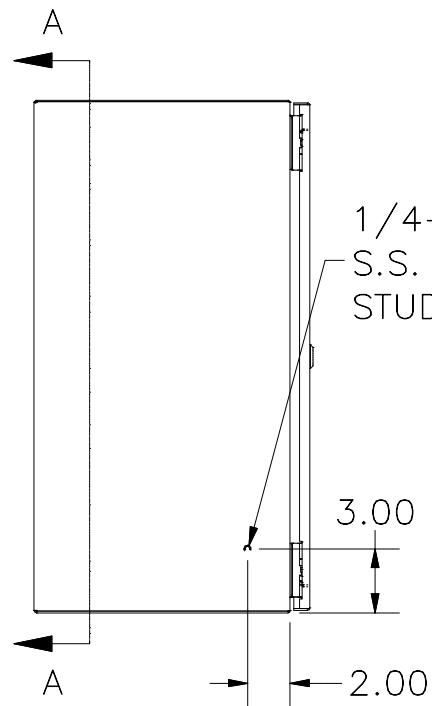

LEFT SIDE VIEW

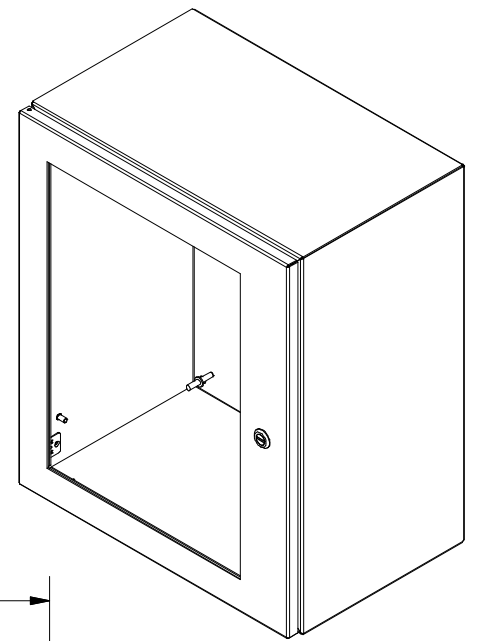
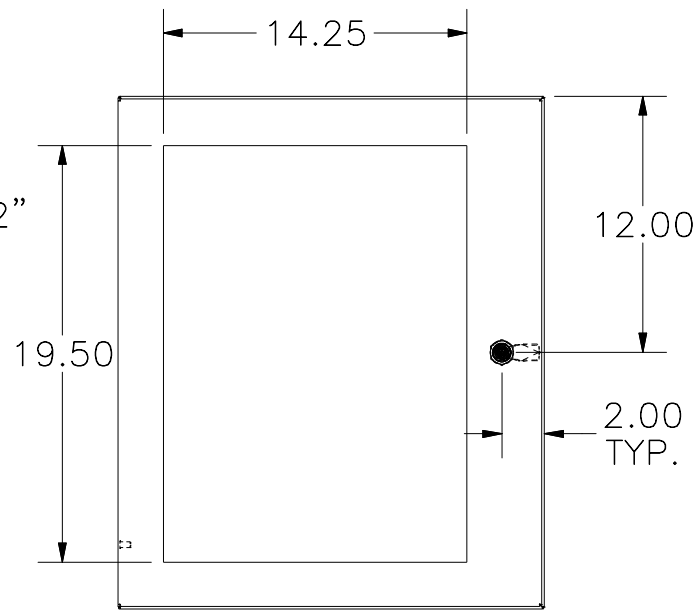

FRONT VIEW

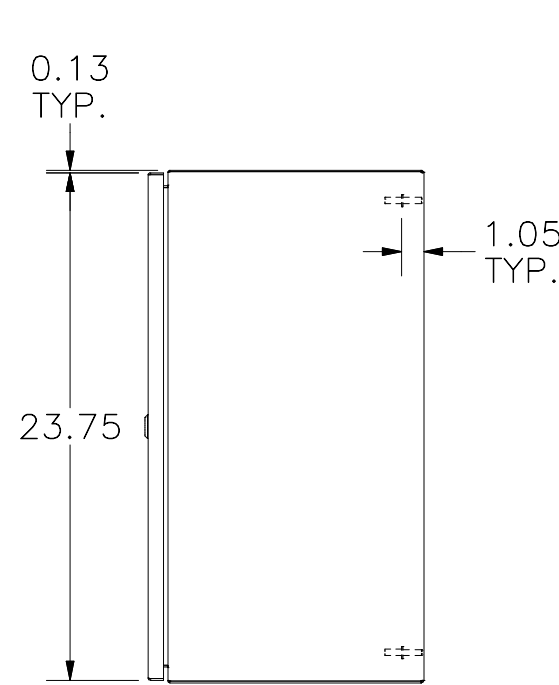

RIGHT SIDE VIEW

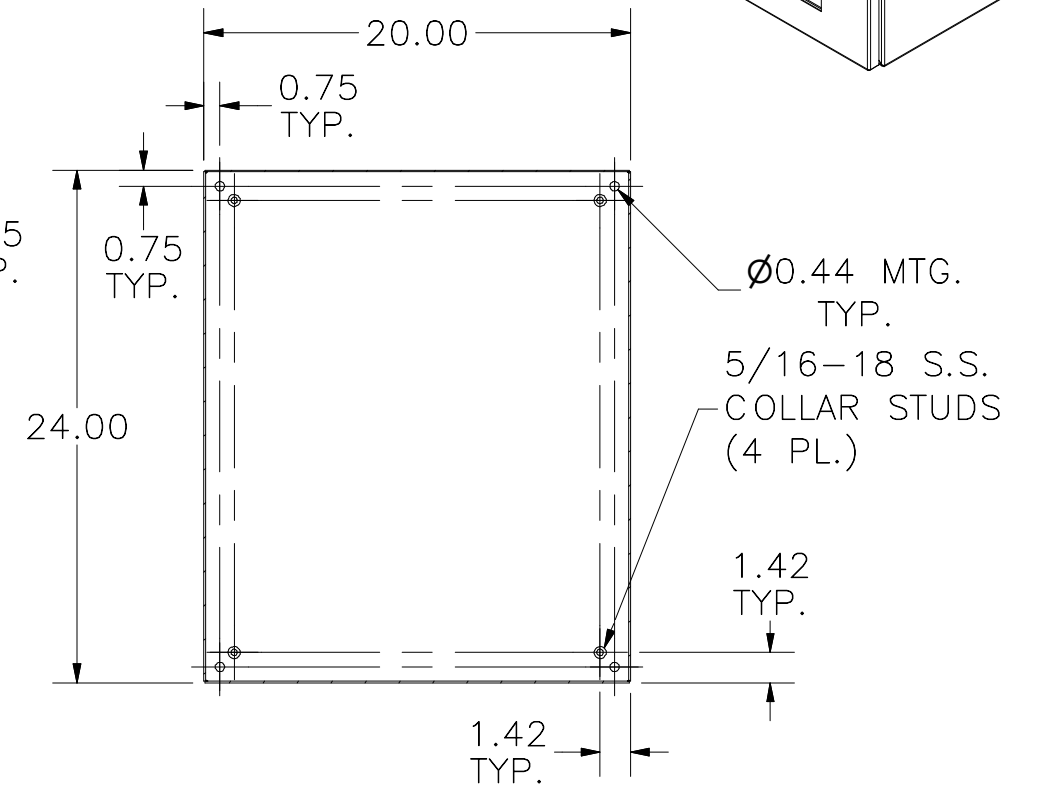

SECTION A-A

(INSIDE BACK OF ENCLOSURE)

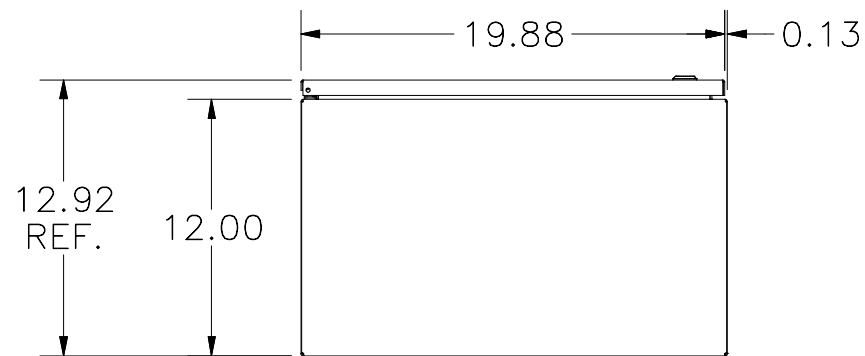

BOTTOM VIEW

PART#: N412242012WCLG  
 (DATA SUBJECT TO CHANGE WITHOUT NOTICE)