

TOP VIEW

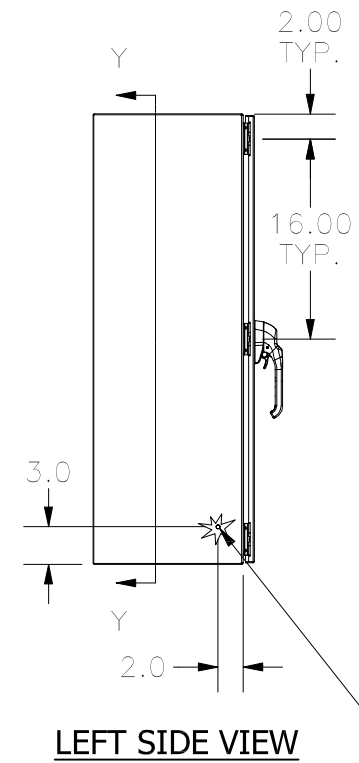

LEFT SIDE VIEW

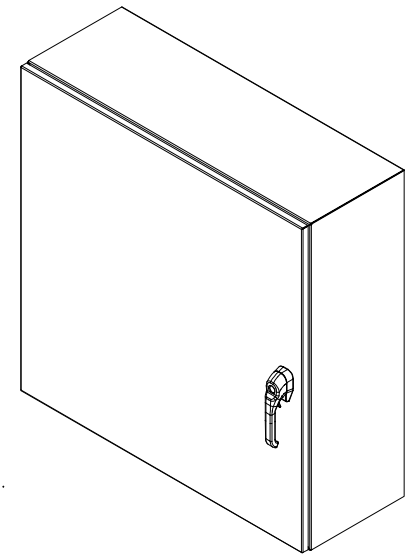
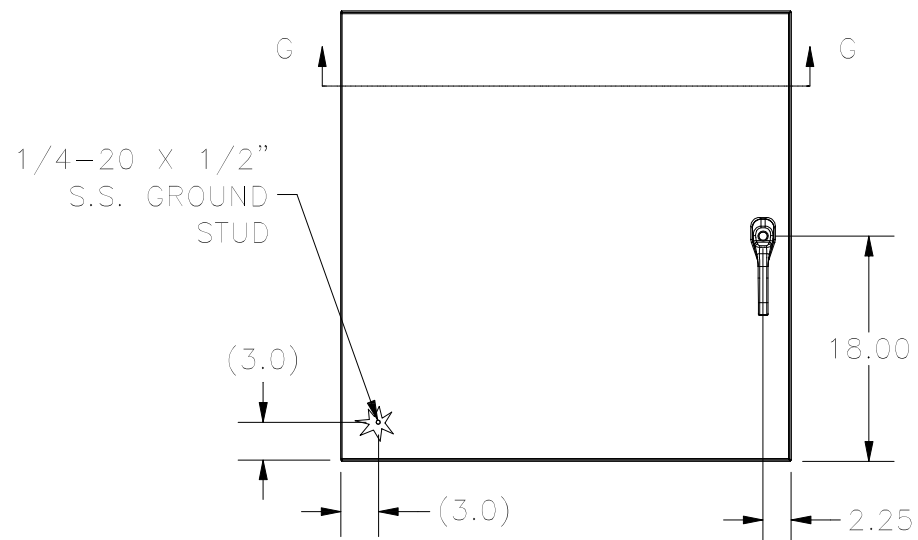

FRONT VIEW



RIGHT SIDE VIEW

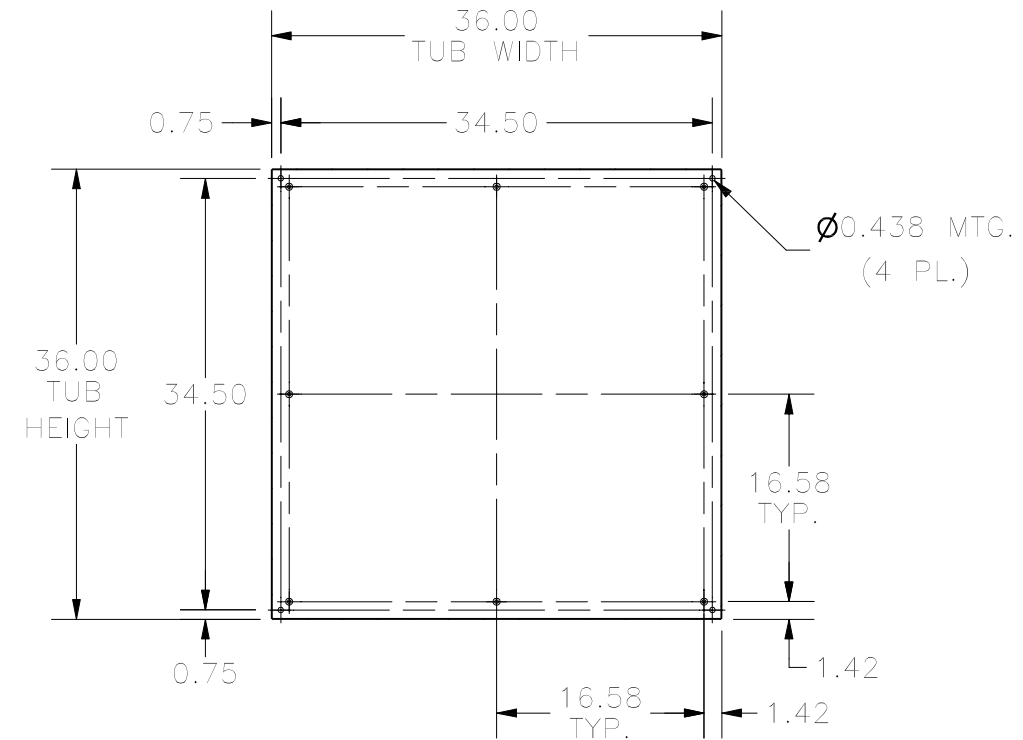

SECTION Y-Y (INSIDE BACK OF ENCLOSURE)

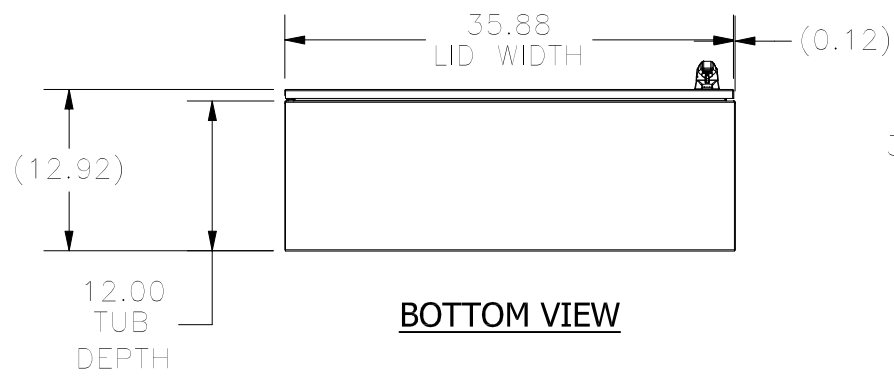

BOTTOM VIEW

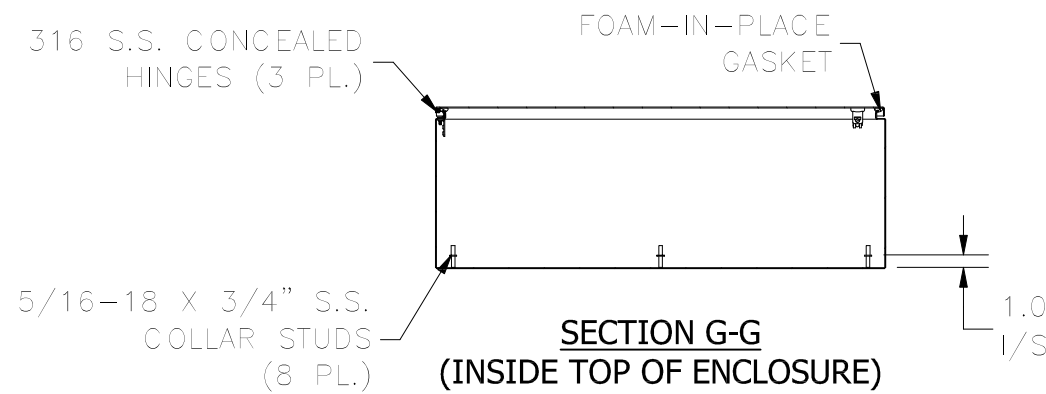

SECTION G-G (INSIDE TOP OF ENCLOSURE)

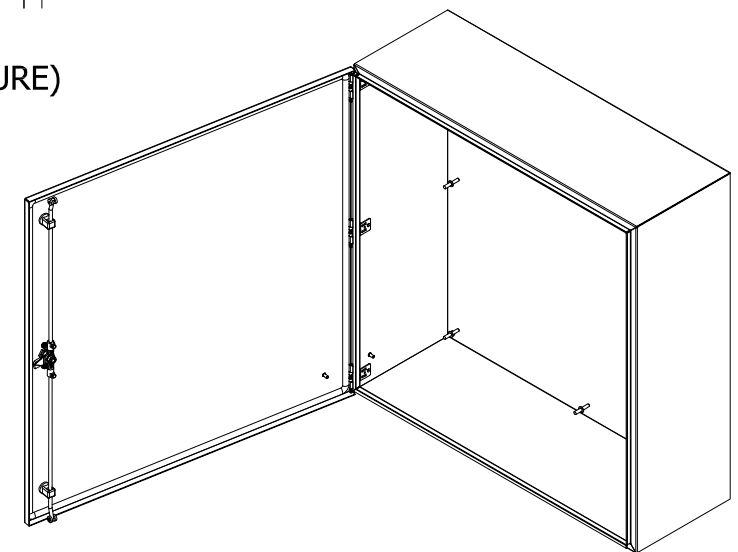

PART #: N412363612SS3PTC
 (DATA SUBJECT TO CHANGE WITHOUT NOTICE.)

THIS DRAWING IS PROPERTY OF HUBBELL INC. WIEGMANN
 ALL INFORMATION IS PROPRIETARY AND NOT TO BE DUPLICATED