

TOP VIEW

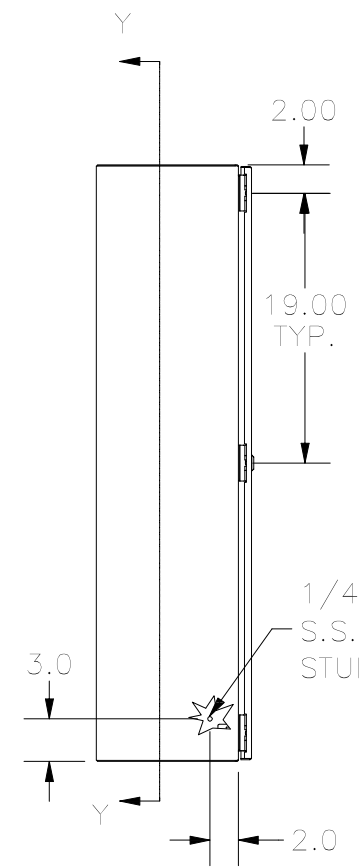

LEFT SIDE VIEW

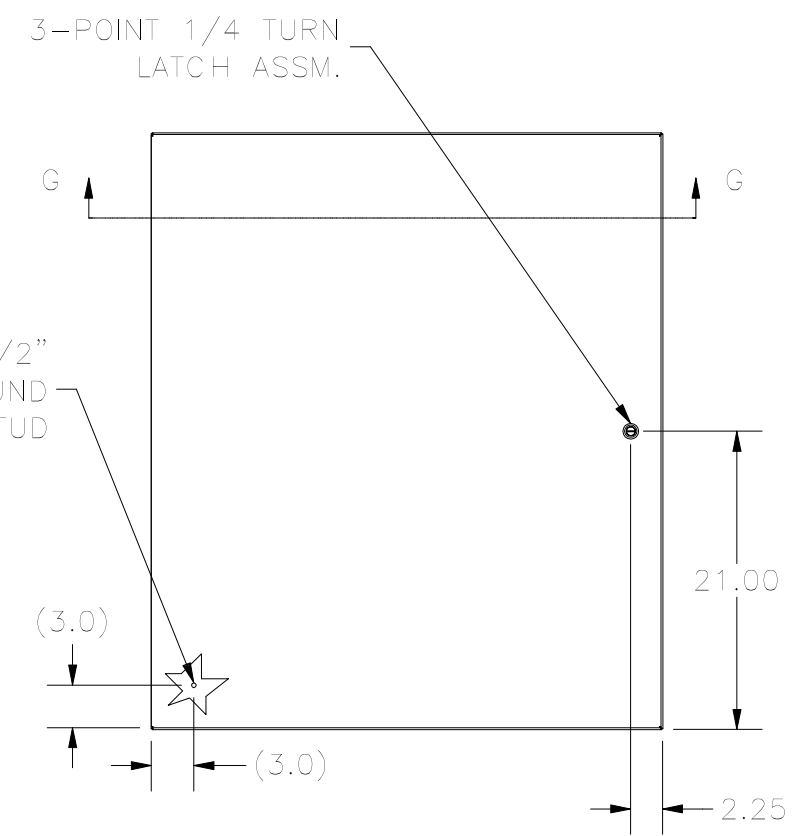

FRONT VIEW



RIGHT SIDE VIEW

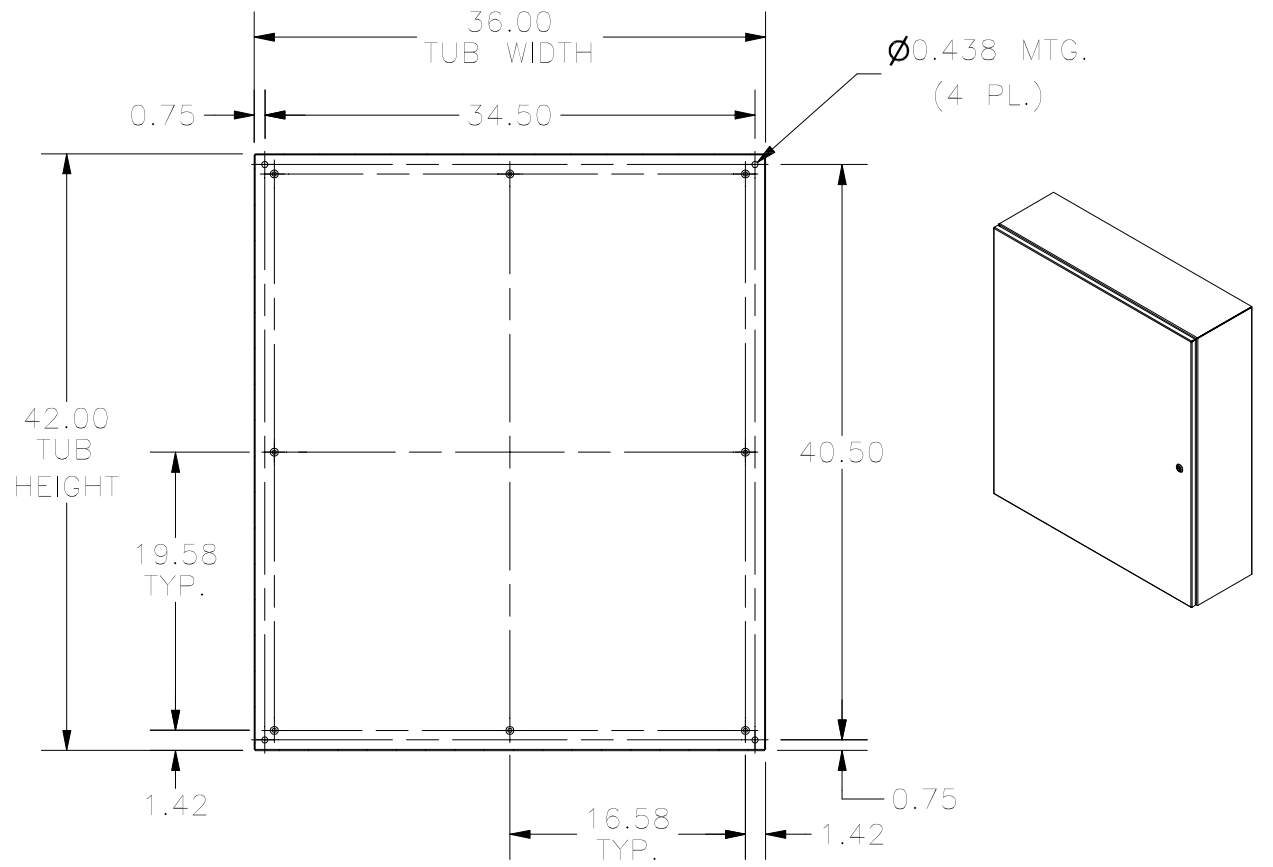

**SECTION Y-Y
(INSIDE BACK OF ENCL.)**

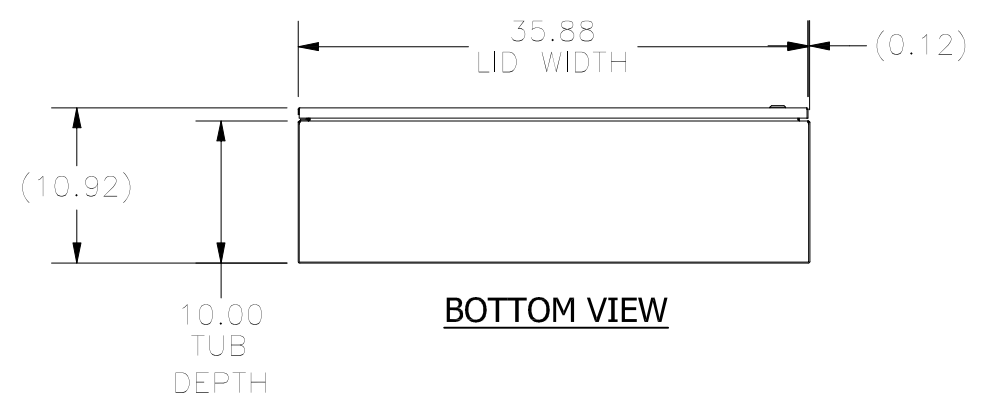

BOTTOM VIEW

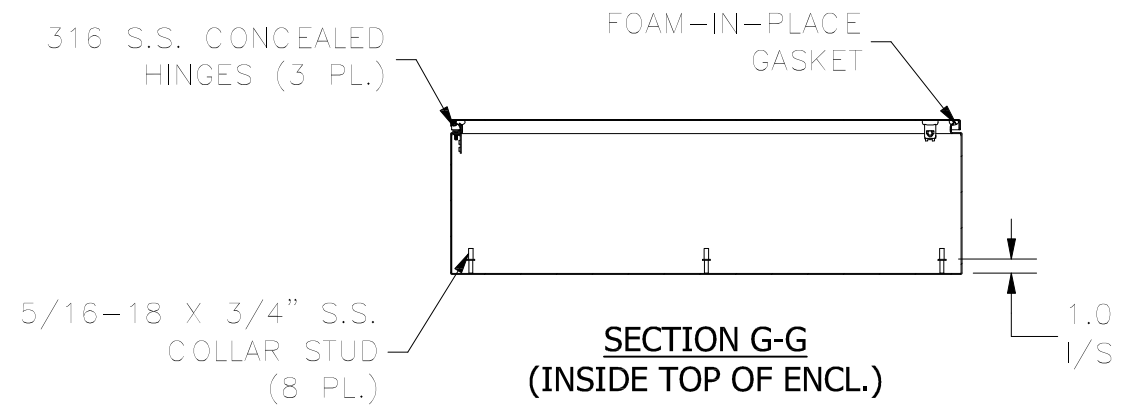

**SECTION G-G
(INSIDE TOP OF ENCL.)**

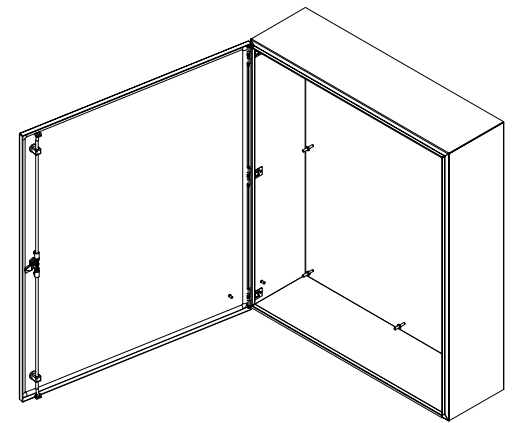

PART #: N412423610SSC
(DATA SUBJECT TO CHANGE WITHOUT NOTICE.)

THIS DRAWING IS PROPERTY OF HUBBELL INC. WIEGMANN
ALL INFORMATION IS PROPRIETARY AND NOT TO BE DUPLICATED