

TOP VIEW

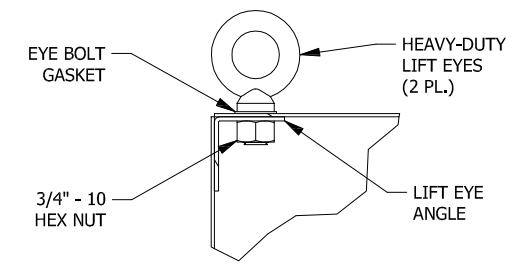

**DETAIL AD
(LIFT EYE ASSEMBLY VIEW)**

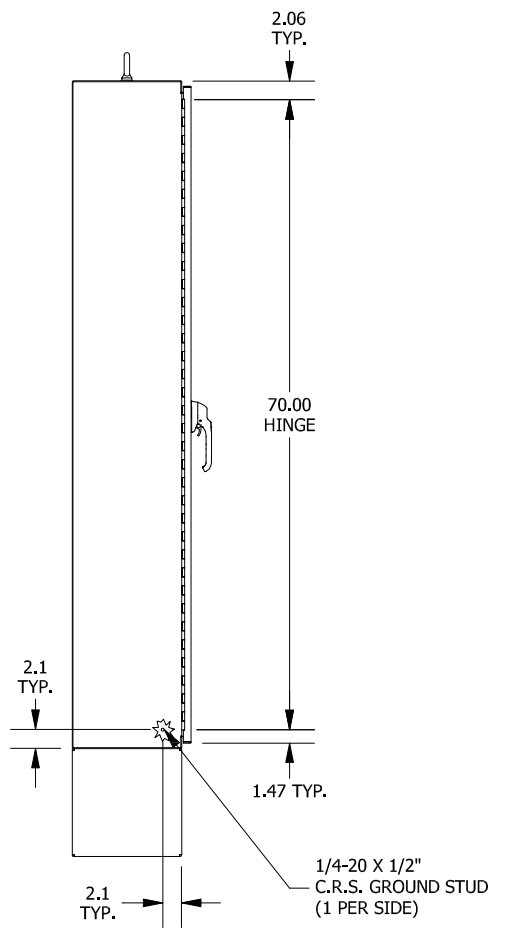

LEFT SIDE VIEW

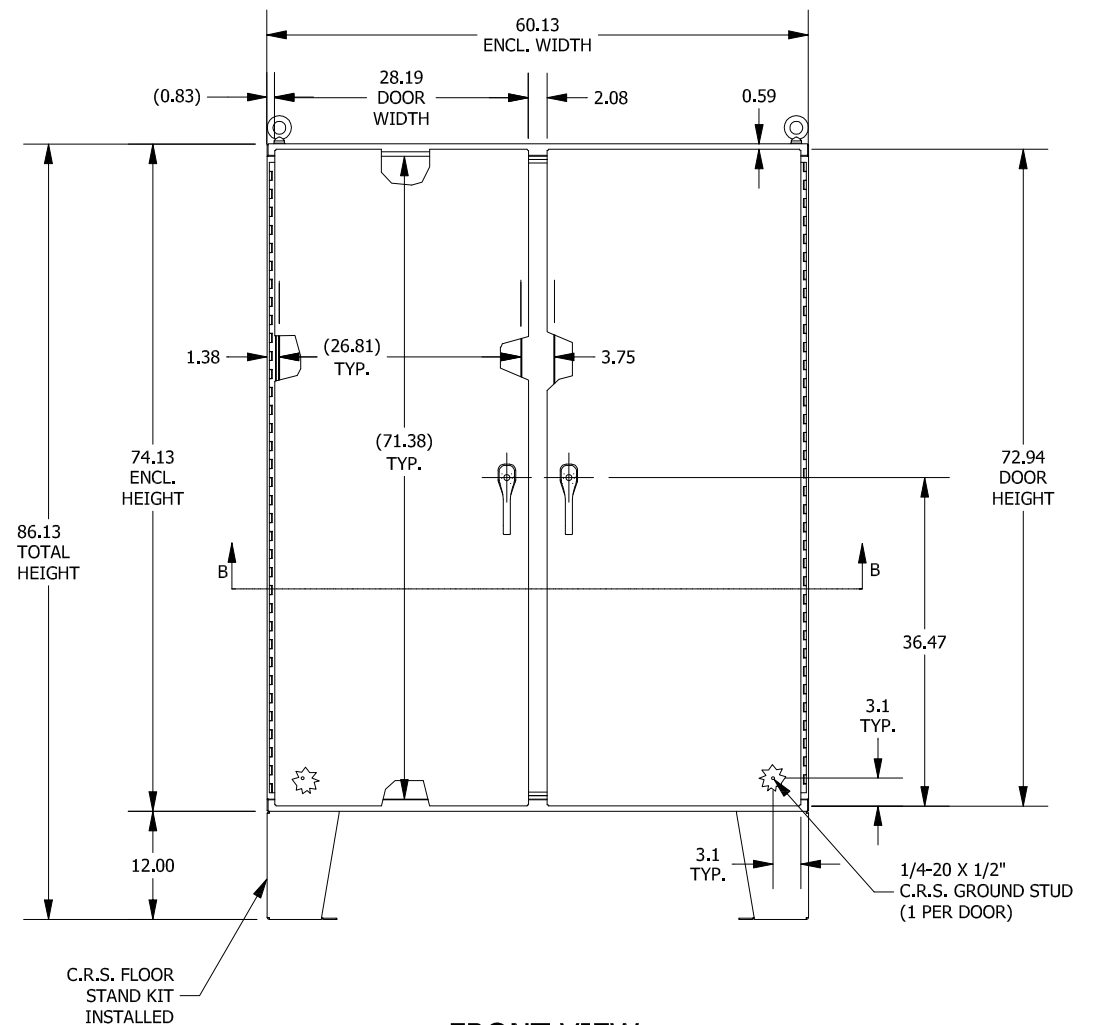

FRONT VIEW

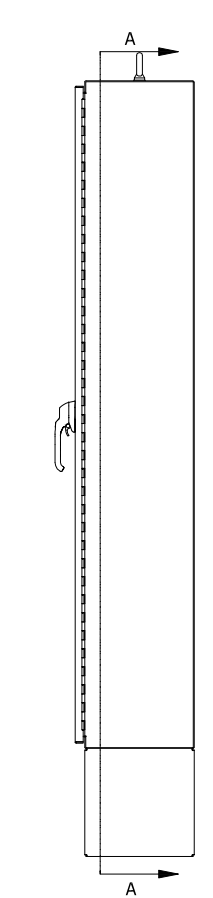

RIGHT SIDE VIEW

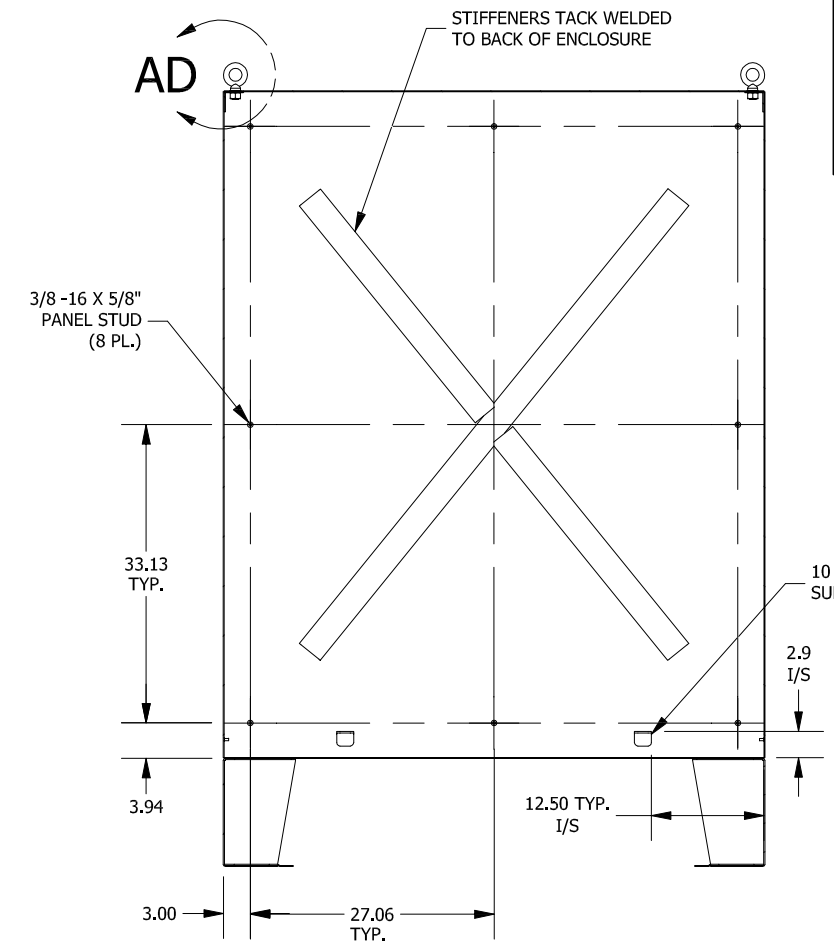

**SECTION A-A
(INSIDE BACK VIEW OF ENCLOSURE)**

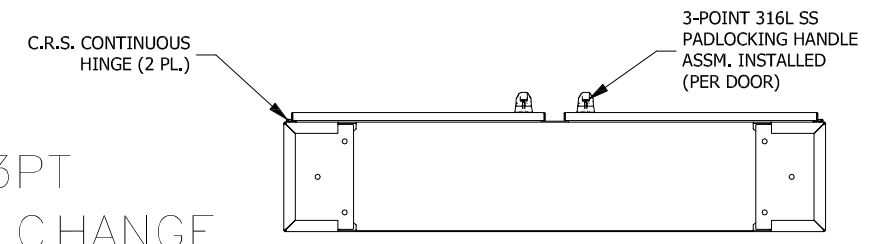

BOTTOM VIEW

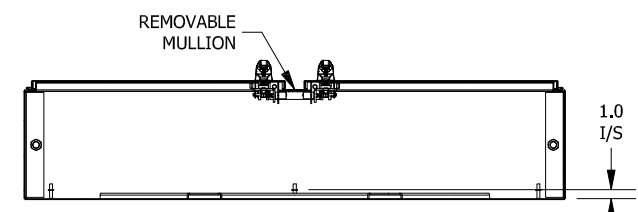

**SECTION B-B
(INSIDE VIEW OF TOP)**

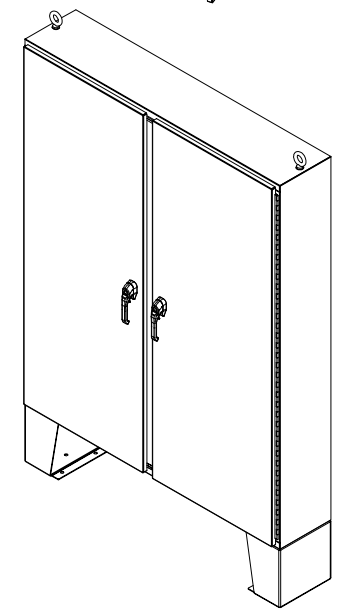
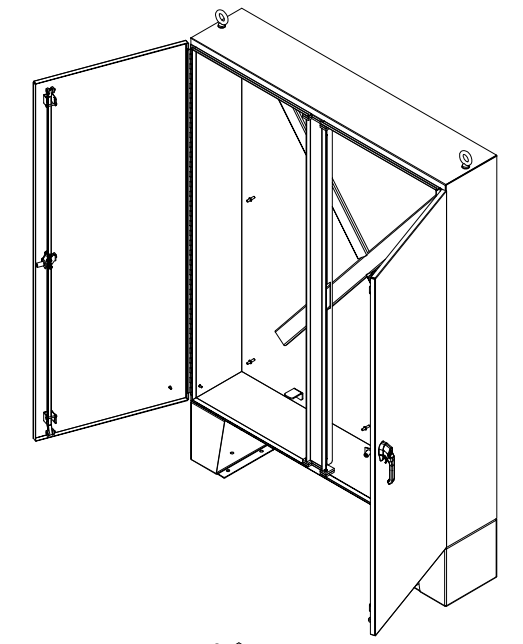

PART#: N4D7460123PT
(DATA SUBJECT TO CHANGE WITHOUT NOTICE)

THIS DRAWING IS PROPERTY OF HUBBELL INC. WIEGMANN
ALL INFORMATION IS PROPRIETARY AND NOT TO BE DUPLICATED