

DATE
NOV. 23, 2010
CAT. #: NP0054

OUTLINE DIMENSIONS
3-PHASE INDUCTION MOTOR

MOTOR TYPE:
AEHH8P
FRAME NO. 184T

Pole	HP	kW	Hz	VOLT	Syn.Speed r/min(rpm)
4	5	3.73	60	230/460	1800

Ins	Rating	Dimension in	Approx Weight	Bearings	
F	CONT.	inch	95 lbs.	DE: 6306ZZ	NDE: 6306ZZ

Totally Enclosed Fan Cooled Squirrel Cage Rotor.

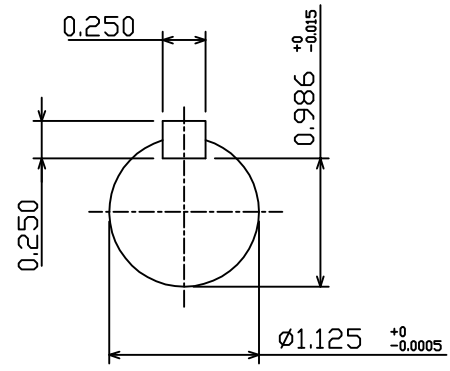
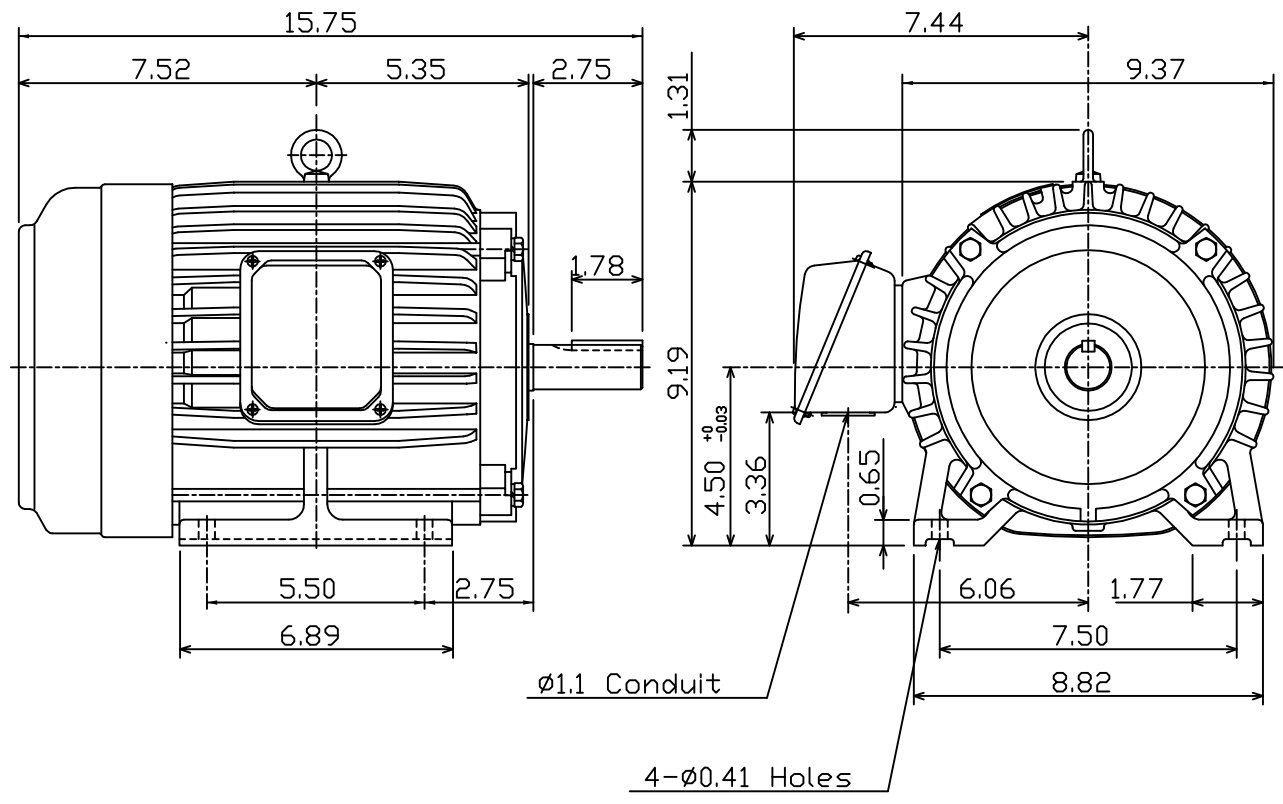

DWN.	J.H.LIANG	05-20-99
CHKD.	C.S.LO	05-26-99
APPD.	Y.B.HUANG	05-26-99



DWG NO.
31049D190560