

DATE
DEC. 13, 2010
CAT. #: NP0252

OUTLINE DIMENSIONS
3-PHASE INDUCTION MOTOR

MOTOR TYPE:
AEHH8P
FRAME NO. 284TS

Pole	HP	kW	Hz	VOLT	Syn.Speed r/min(rpm)
2	25	18.7	50	190/380	3000

Ins	Rating	Dimension in	Approx Weight	Bearings
F	CONT.	inch	381 lbs.	DE: 6211C3 NDE: 6211C3

Totally Enclosed Fan Cooled Type, Squirrel-cage Rotor.

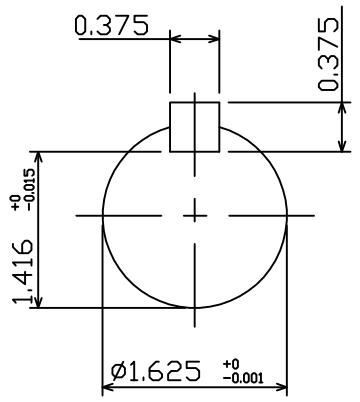
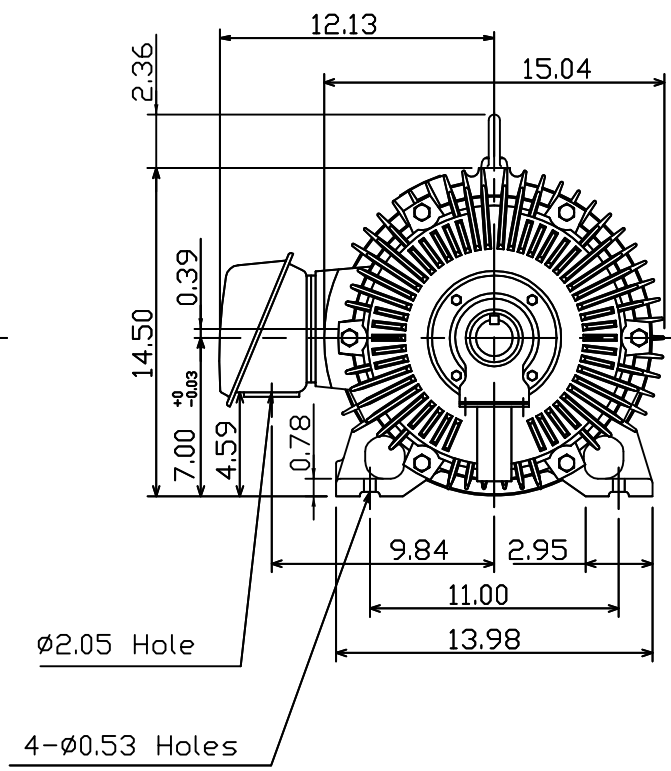
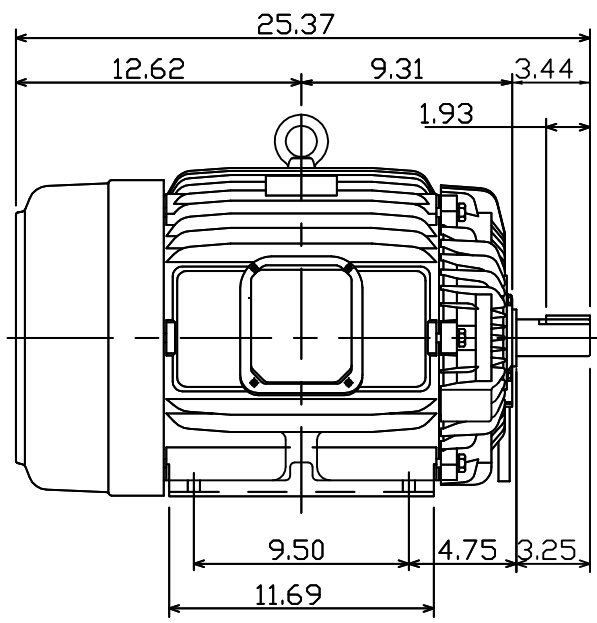

12.06.10 郭耿良

DWN, J.H.LIANG 05 :20 99
CHKD, C.H.KAD 06 :15 99
APPD, Y.B.HUANG 06 :15 99



DWG NO.
31049J350083