

**FRONT VIEW**

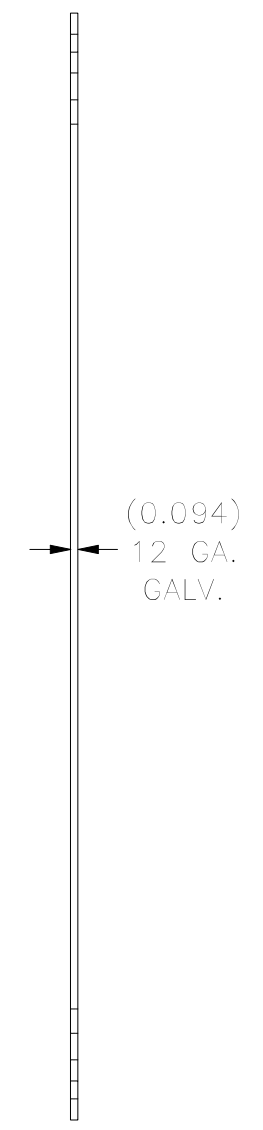

**SIDE VIEW**

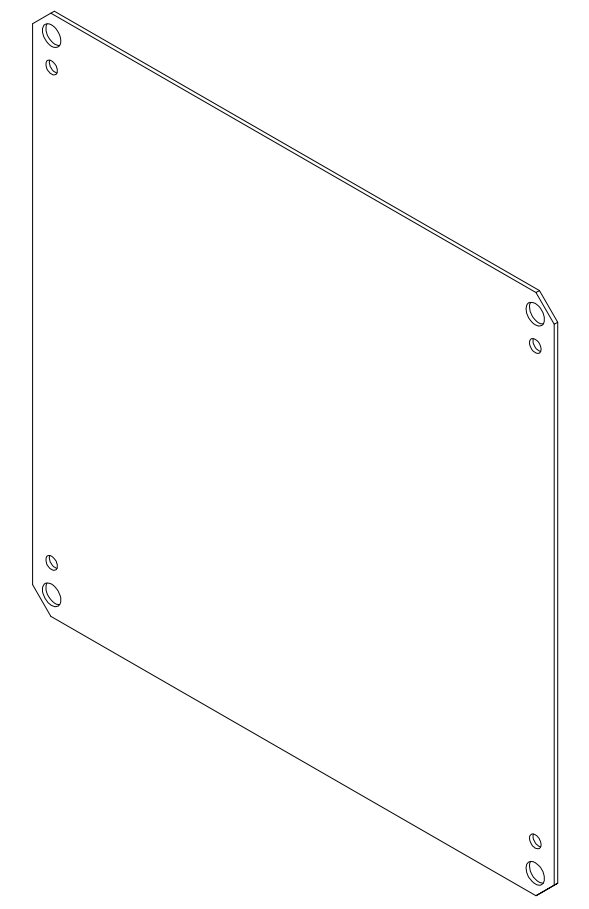

PART#: NP1616CG  
 (DATA SUBJECT TO CHANGE WITHOUT NOTICE)  
 THIS DRAWING IS PROPERTY OF HUBBELL INC. WIEGMANN  
 ALL INFORMATION IS PROPRIETARY AND NOT TO BE DUPLICATED