

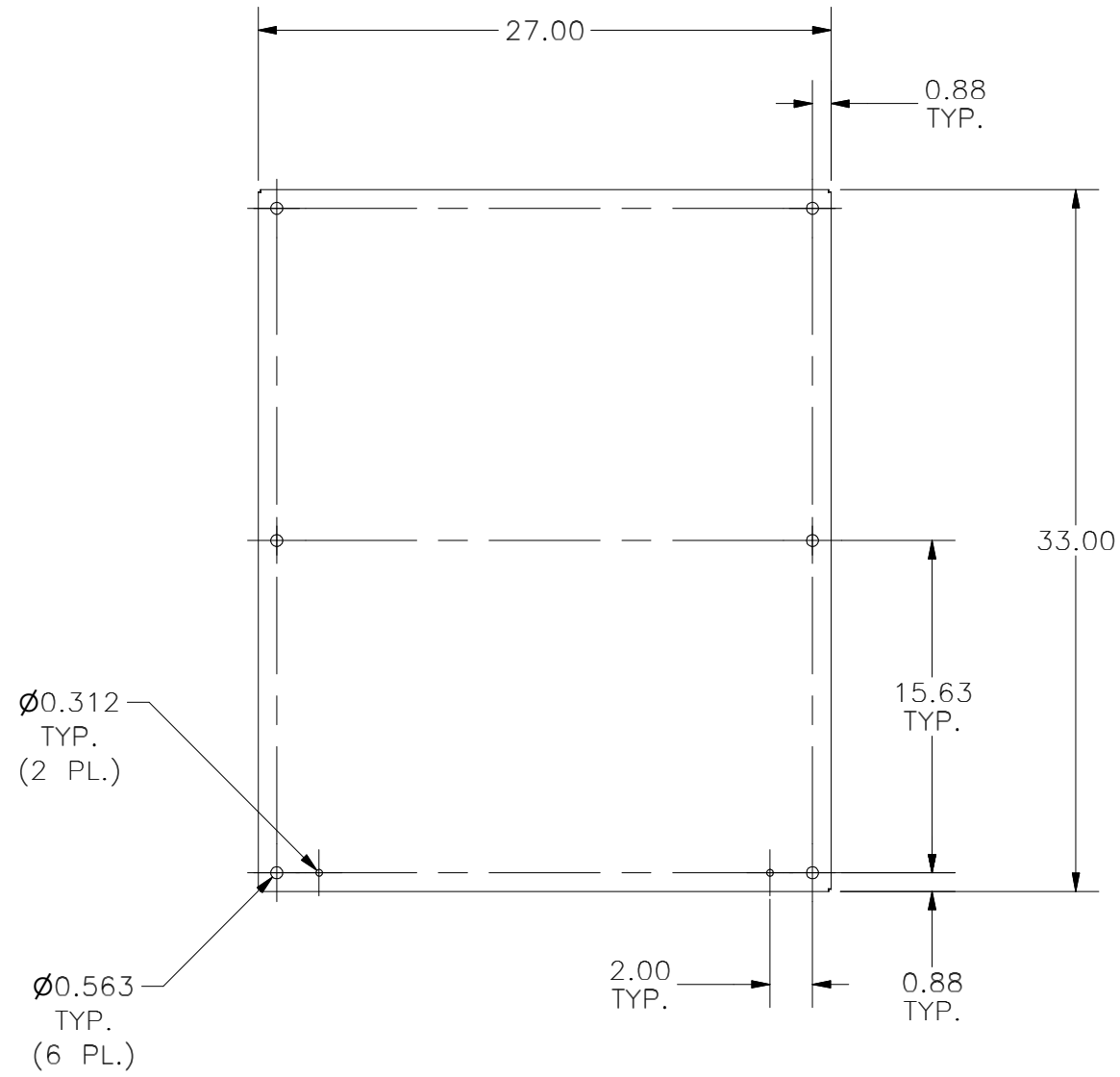

TOP VIEW

PART#: NP3630SS
(DATA SUBJECT TO CHANGE WITHOUT NOTICE)

THIS DRAWING IS PROPERTY OF HUBBELL INC. WIEGMANN
 ALL INFORMATION IS PROPRIETARY AND NOT TO BE DUPLICATED



FRONT VIEW

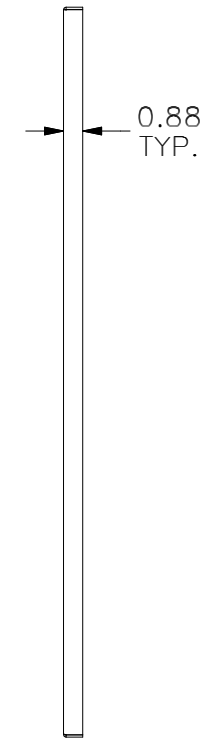

SIDE VIEW

