

DATE
APRIL 25, 2011
CAT. #: NP7/52C

OUTLINE DIMENSIONS
3-PHASE INDUCTION MOTOR

MOTOR TYPE:
AEHH8P-CF
FRAME NO. 213TC

Pole	HP	kW	Hz	VOLT	Syn.Speed r/min(rpm)
2	7.5	5.6	50	190/380	3000

Ins	Rating	Dimension in	Approx Weight	Bearings
F	CONT.	inches	161 lbs.	DE: 6308ZZ NDE: 6306ZZ

Totally Enclosed Fan-Cooled Type, Squirrel-Cage Rotor.

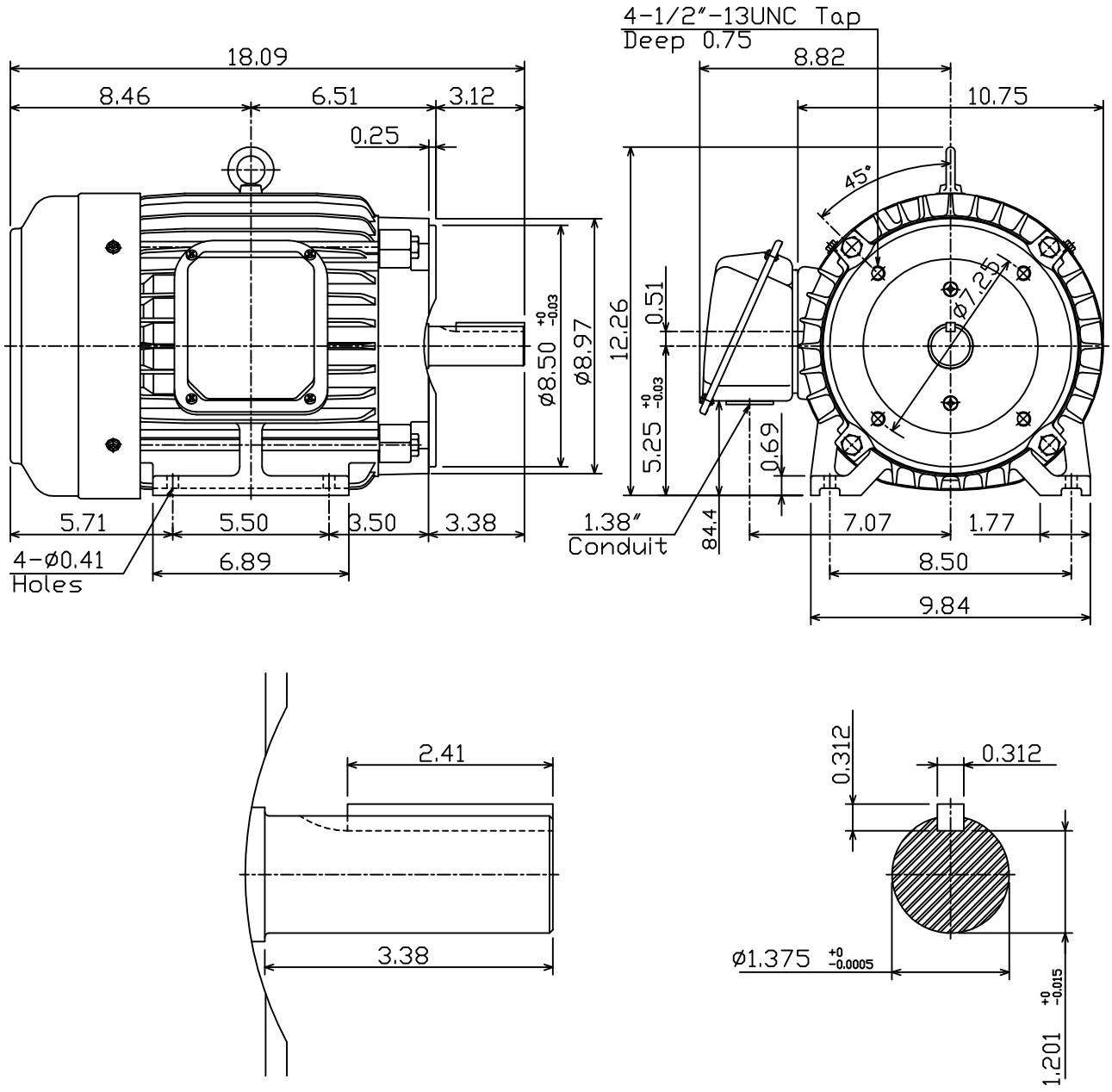

DWN.	F.Z.HWANG	07-31-00
CHKD.	C.S.LO	02-11-03
APPD.	Y.B.HUANG	02-11-03



DWG NO.
31049D191590