

**TOP VIEW**

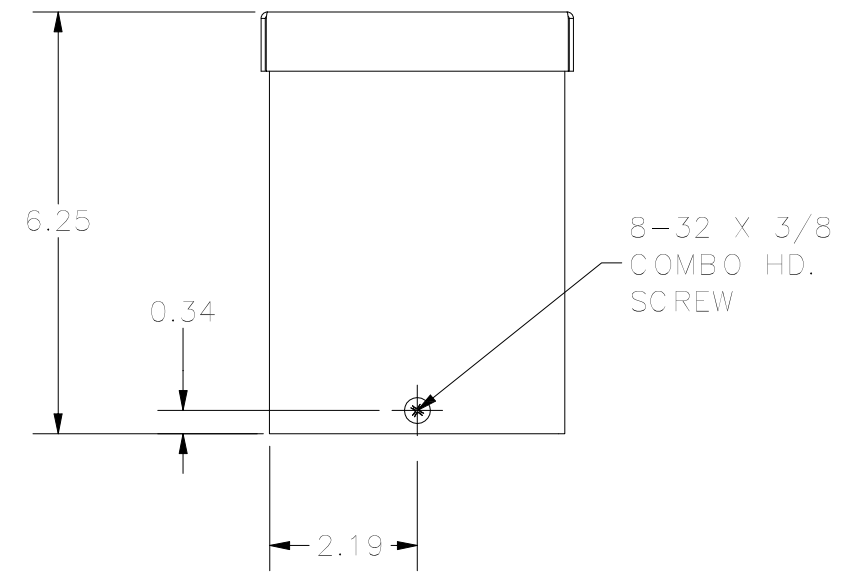

**FRONT VIEW**

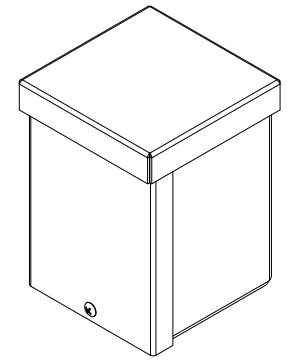
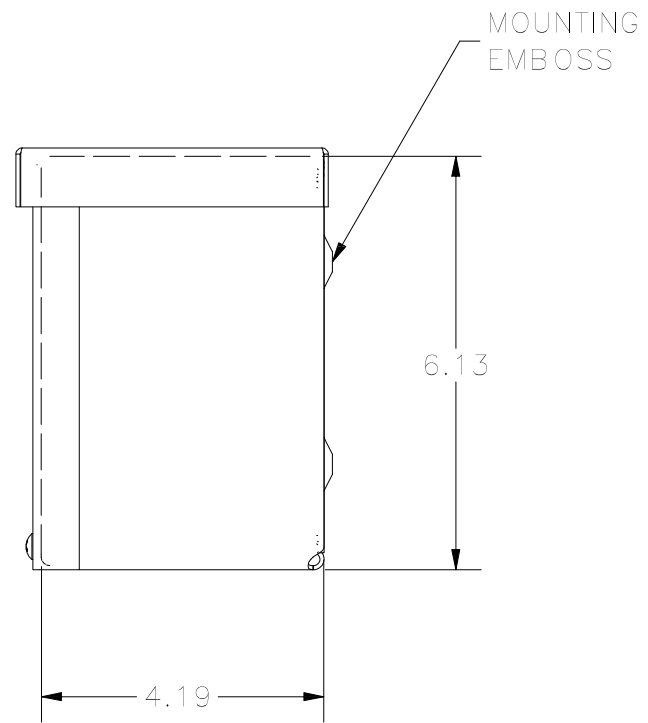

**RIGHT VIEW**

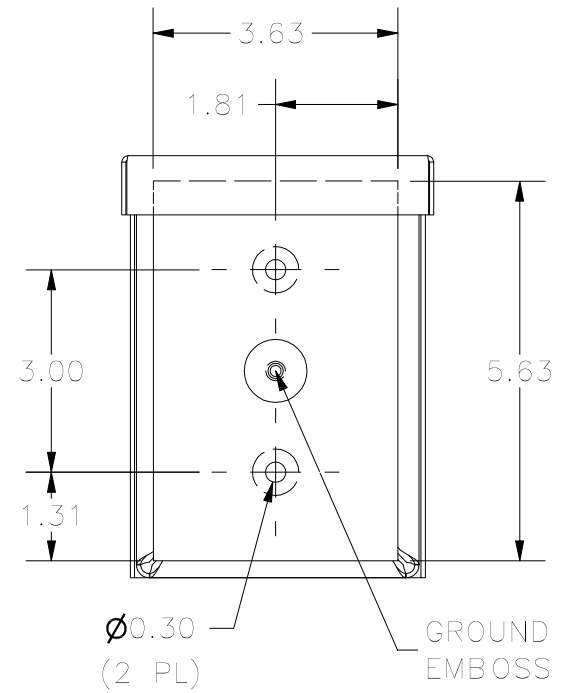

**BACK VIEW**

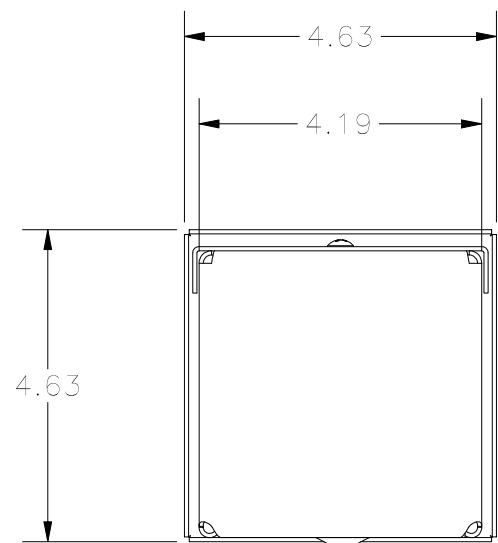

**BOTTOM VIEW**

PART#: RSC040604GNK  
(DATA SUBJECT TO CHANGE WITHOUT NOTICE)

THIS DRAWING IS PROPERTY OF HUBBELL INC. WIEGMANN  
ALL INFORMATION IS PROPRIETARY AND NOT TO BE DUPLICATED