

**DETAIL A (3 PL.)**  
(LID ATTACHMENT DETAIL)

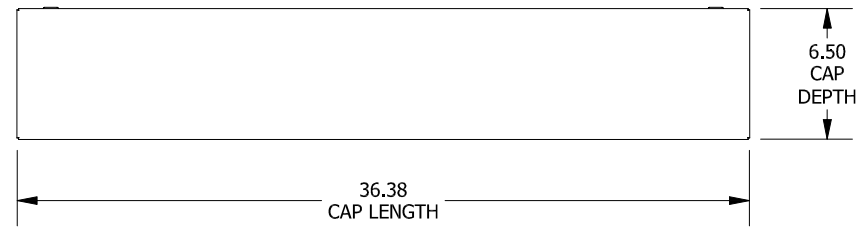

**TOP VIEW**

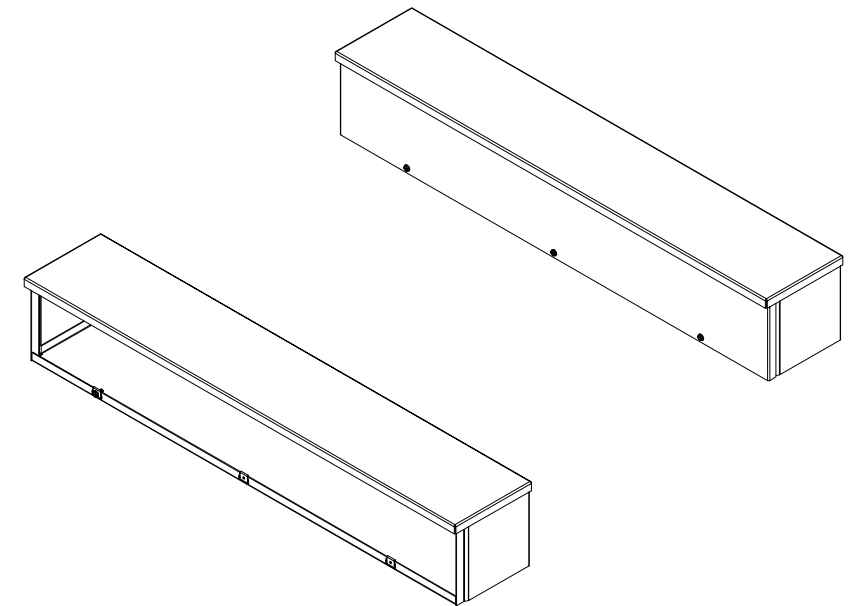
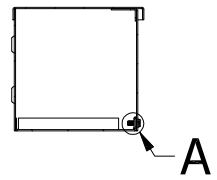

**SECTION A-A**  
(INSIDE RIGHT OF ENCL.)

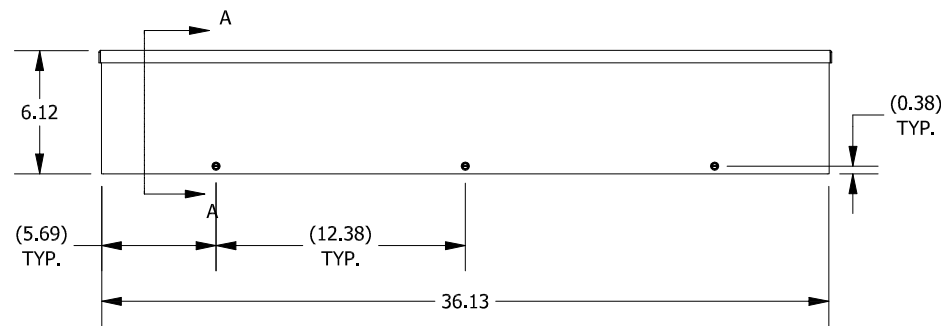

**FRONT VIEW**

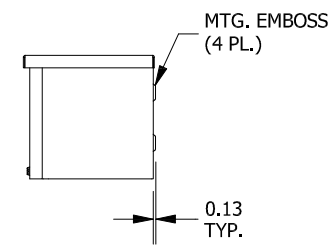

**RIGHT SIDE VIEW**

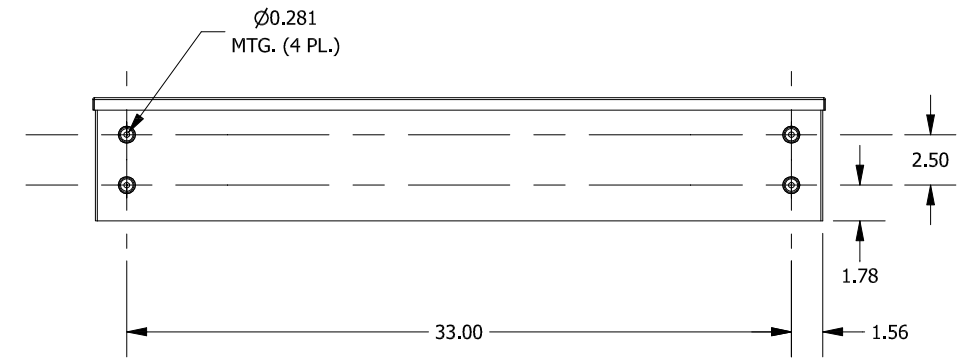

**BACK VIEW**

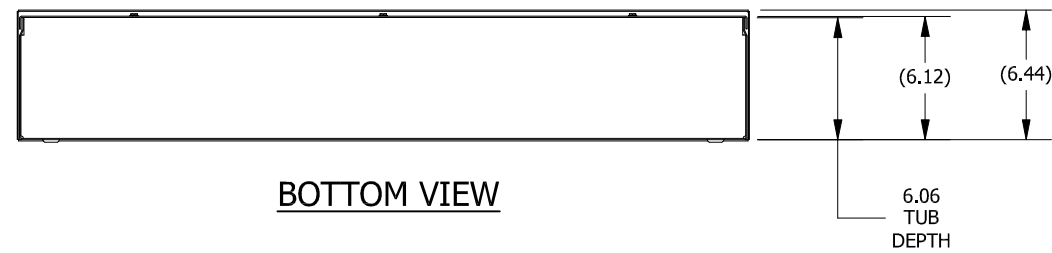

**BOTTOM VIEW**

PART#: RSCG060636NK  
(DATA SUBJECT TO CHANGE WITHOUT NOTICE)

THIS DRAWING IS PROPERTY OF HUBBELL INC. WIEGMANN  
ALL INFORMATION IS PROPRIETARY AND NOT TO BE DUPLICATED