

TOP VIEW

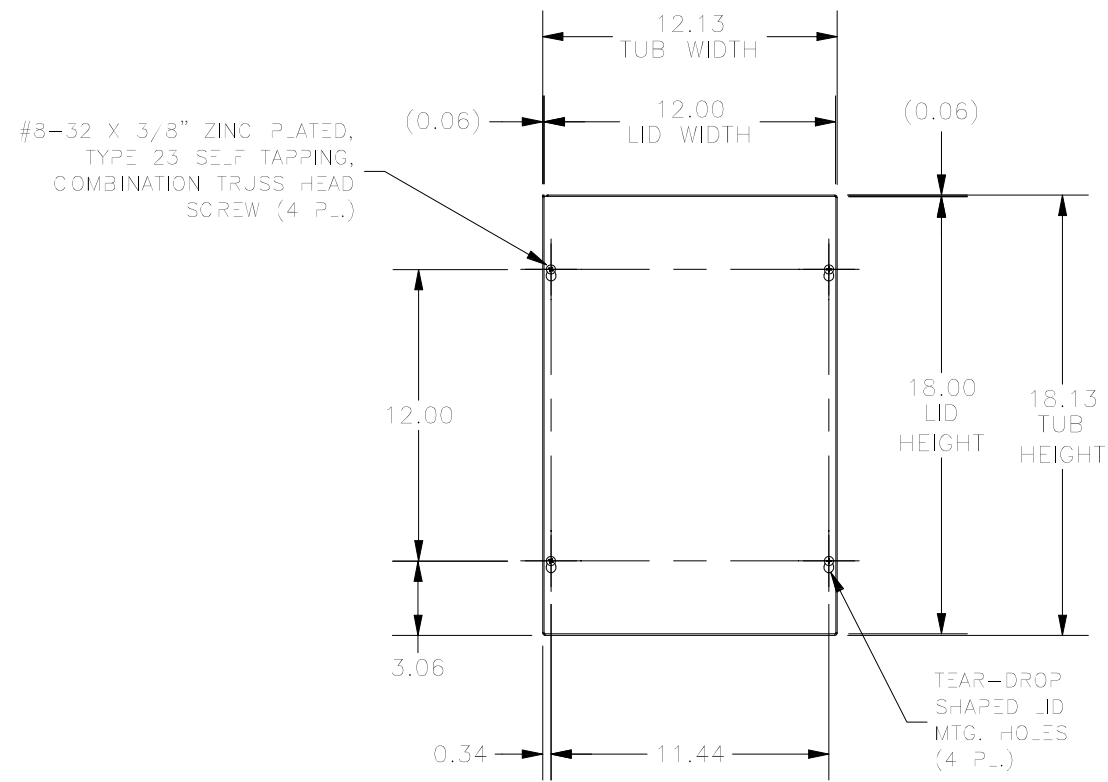

FRONT VIEW

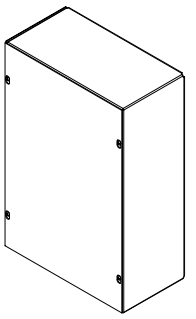
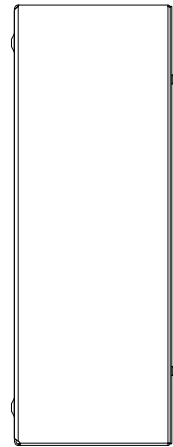

LEFT SIDE VIEW

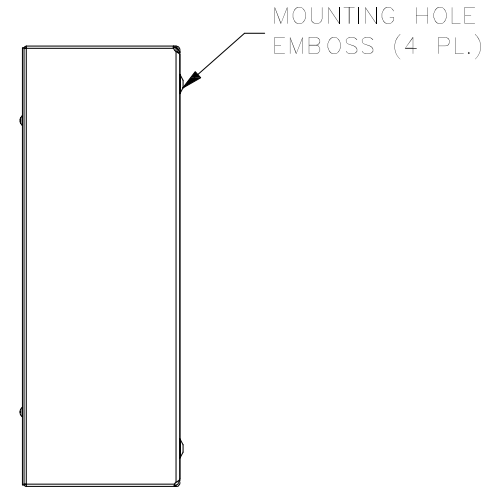

RIGHT SIDE VIEW

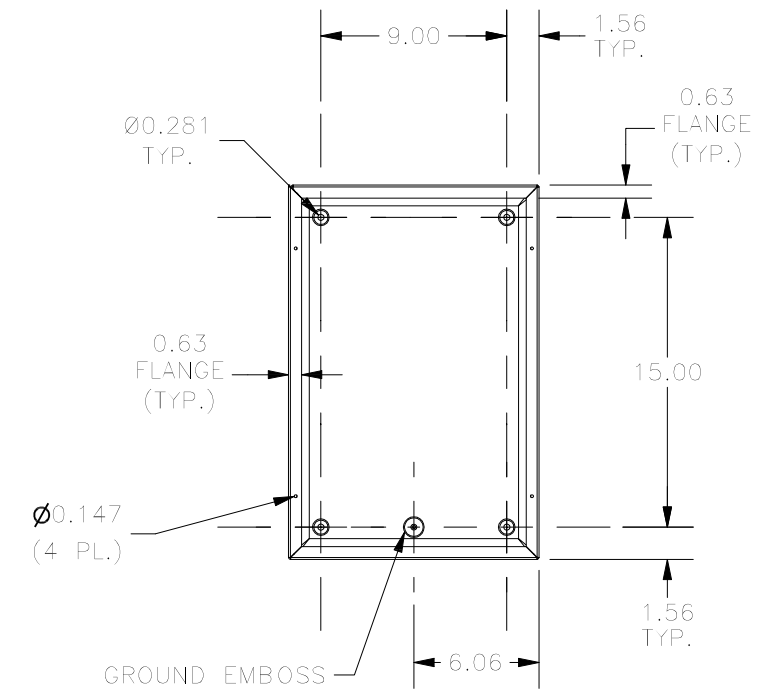

FRONT VIEW LID REMOVED



BOTTOM VIEW

PART#: SC121806GNK
 (DATA SUBJECT TO CHANGE WITHOUT NOTICE)

THIS DRAWING IS PROPERTY OF HUBBELL INC. WIEGMANN
 ALL INFORMATION IS PROPRIETARY AND NOT TO BE DUPLICATED