

**TOP VIEW**

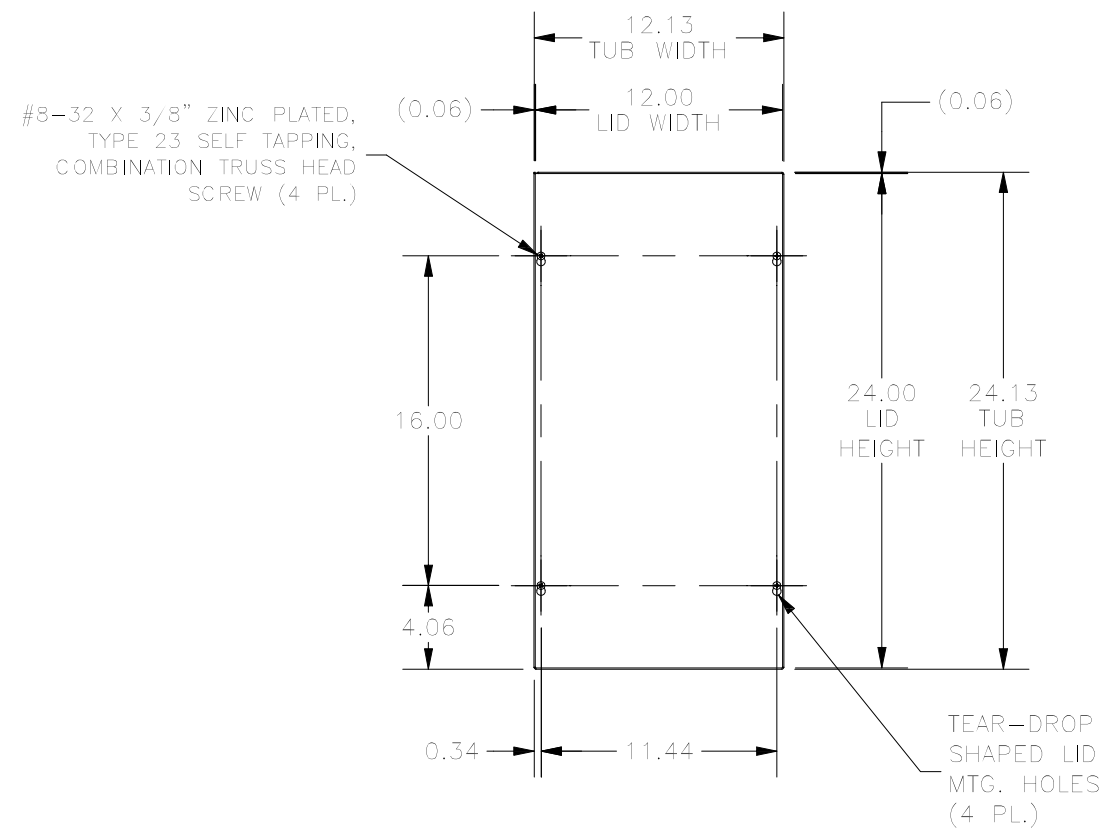

**FRONT VIEW**



**BOTTOM VIEW**

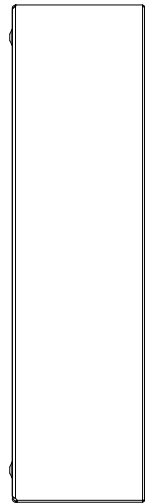

**LEFT SIDE VIEW**

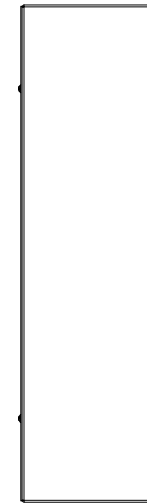

**RIGHT SIDE VIEW**

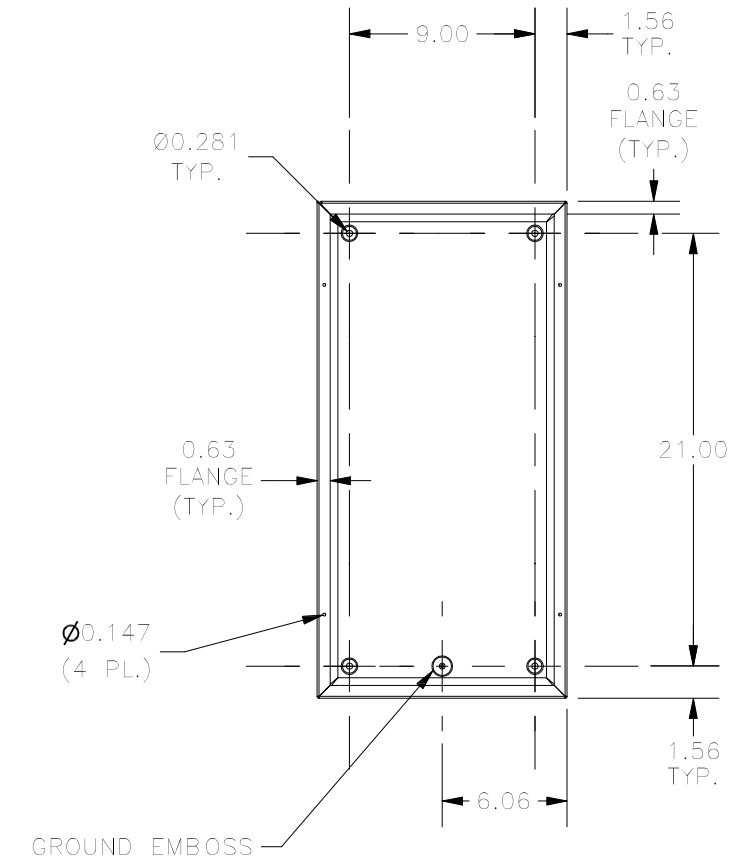

**FRONT VIEW LID REMOVED**

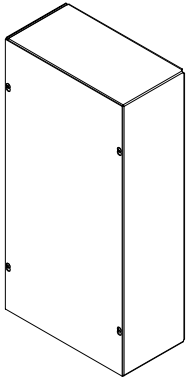

PART#: SC122406GNK  
(DATA SUBJECT TO CHANGE WITHOUT NOTICE)

THIS DRAWING IS PROPERTY OF HUBBELL INC. WIEGMANN  
ALL INFORMATION IS PROPRIETARY AND NOT TO BE DUPLICATED