

TOP VIEW

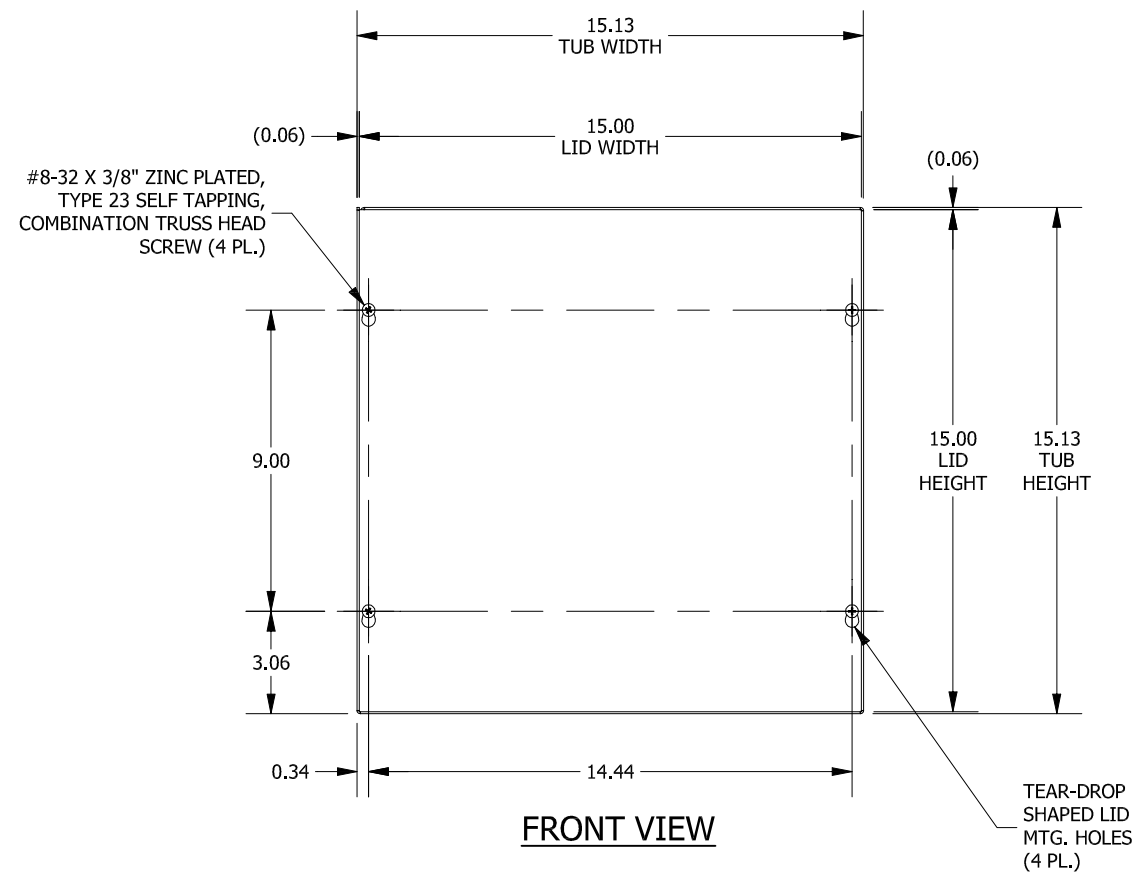

FRONT VIEW

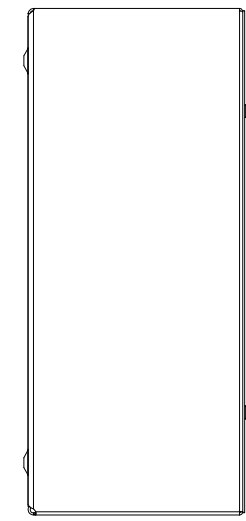

LEFT SIDE VIEW



BOTTOM VIEW

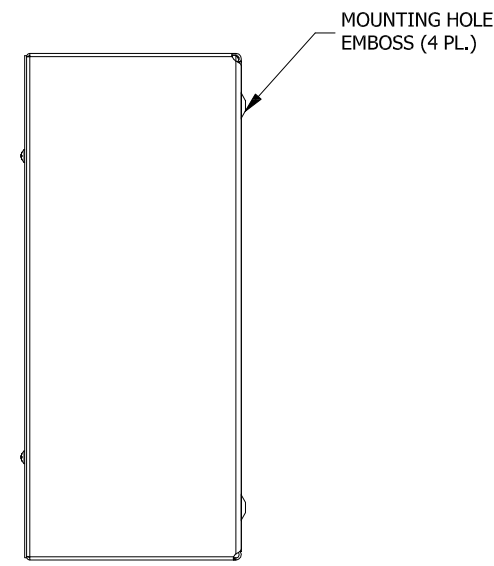

RIGHT SIDE VIEW

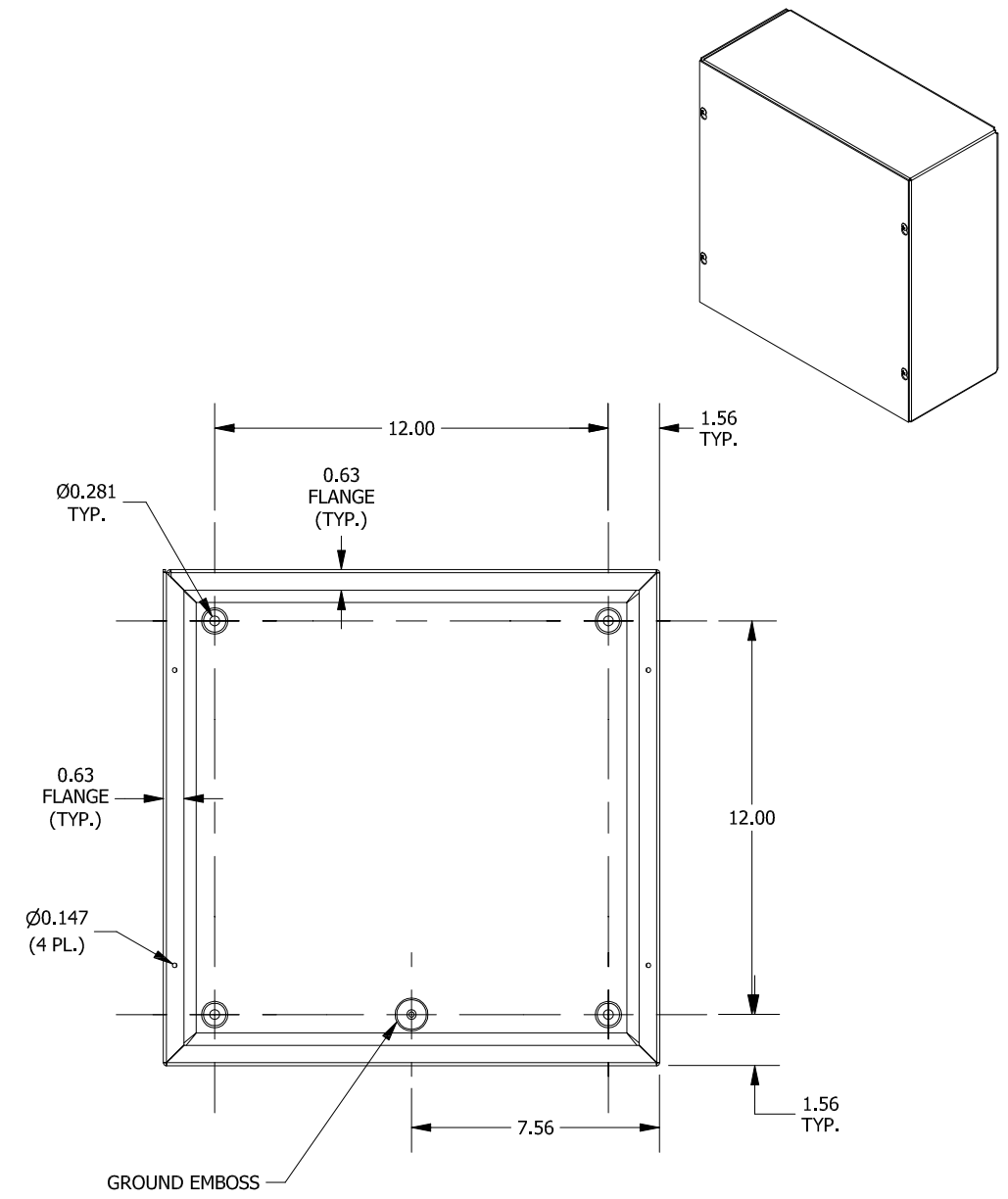

FRONT VIEW LID REMOVED

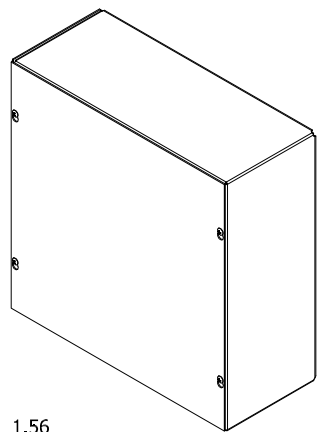

PART#: SC151506GNK
 (DATA SUBJECT TO CHANGE WITHOUT NOTICE)

THIS DRAWING IS PROPERTY OF HUBBELL INC. WIEGMANN
 ALL INFORMATION IS PROPRIETARY AND NOT TO BE DUPLICATED