

TOP VIEW

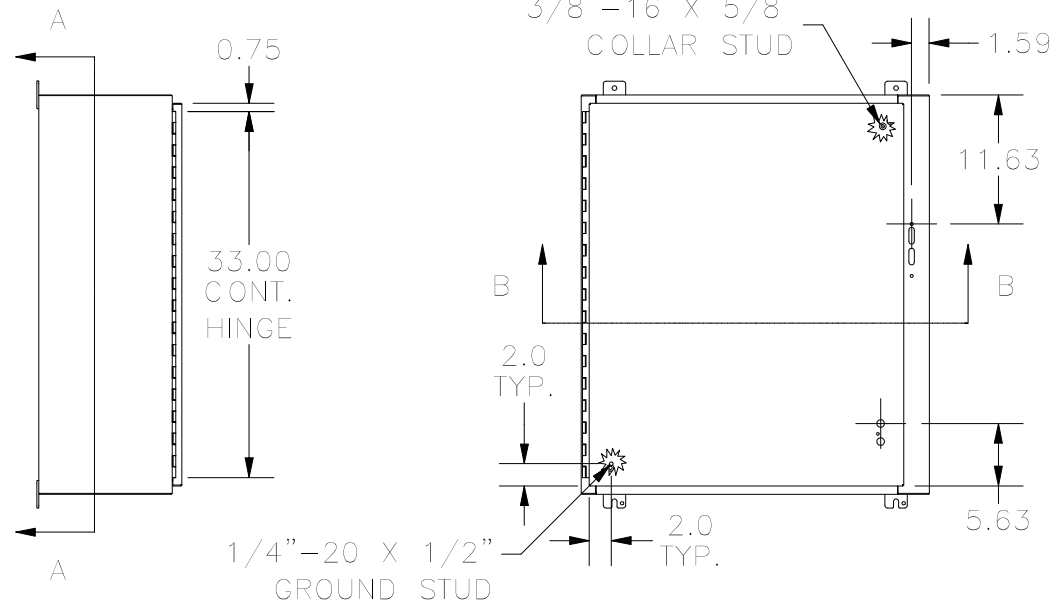

LEFT SIDE

FRONT VIEW

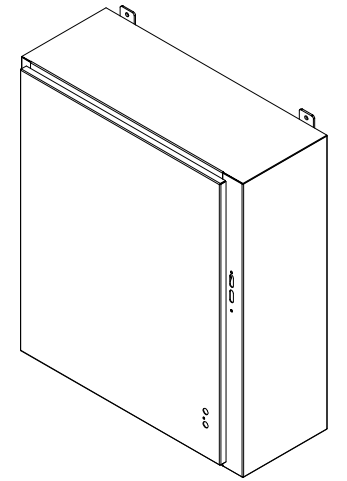
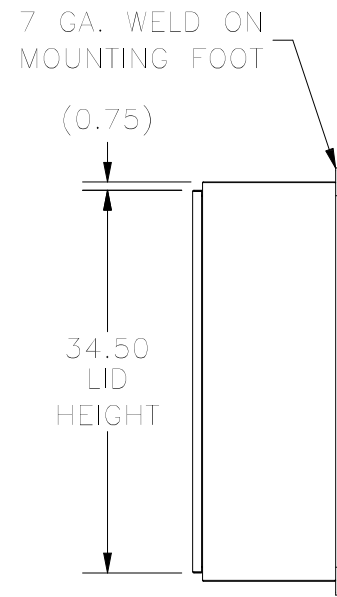

RIGHT SIDE

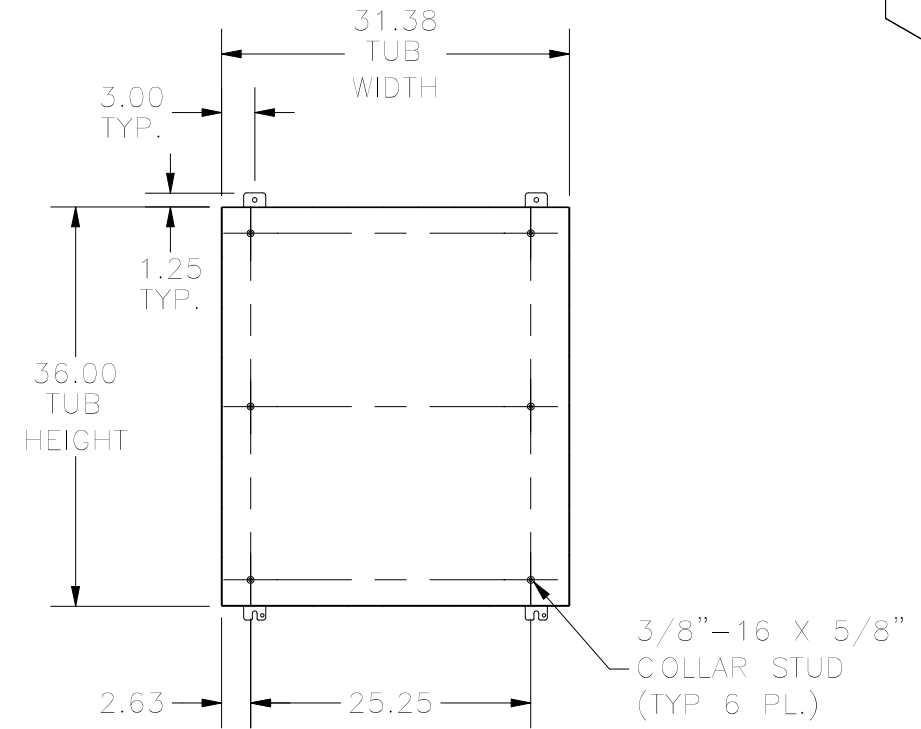

**SECTION A-A
(INSIDE BACK OF TUB)**



BOTTOM VIEW

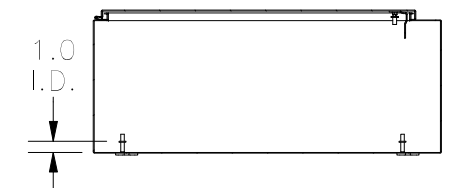

**SECTION B-B
(INSIDE TOP OF ENCLOSURE)**

PART#: SDN12363212
(DATA SUBJECT TO CHANGE WITHOUT NOTICE)

THIS DRAWING IS PROPERTY OF HUBBELL INC. WIEGMANN
ALL INFORMATION IS PROPRIETARY AND NOT TO BE DUPLICATED