

Petrochemical Life Cycle ③ Terminal

The content in this phase of the Petrochemical Life Cycle is focused on the numerous transfer applications in the oil and gas field. Featured are the Dixon® products used within the Terminal segment.

Please refer to the Dixon® Price List or dixonvalve.com for specific part numbers and various other products used in the transfer and control of liquids, gases and dry materials.

Table of Contents

API Couplers	4
Dry Disconnect Couplings	5-7
Vapor Recovery Couplers.....	8-10
Vapor Recovery Adapters.....	11
Rack Cords.....	12-13
Safety Breakaway Couplings.....	14-15
Terminal Components	
TTMA Series Flange Adapters	16
TTMA Flange Gaskets and Screens	17
Betts Wet-R-Dri™ Valve.....	17
TTMA Sight Flow Indicators	18
Loading Arm Components	
Low Pressure Swivels	19
TTMA Flange Extensions	20
Loading Arm Swivels.....	20
Split Flange Swivels	21

Safety

Dixon® couplings and retention devices are designed to work safely for their intended use. The selection of the proper hose, coupling and retention device, and the proper application of the coupling to the hose are of utmost importance.

Users must consider the size, temperature, application, media, pressure and hose and coupling manufacturer's recommendations when selecting the proper hose assembly components. Dixon® recommends that all hose assemblies be tested in accordance with the Association for Rubber Products Manufacturer's (ARPM) recommendations and be inspected regularly (before each use) to ensure that they are not damaged or have become loose. Visit ARPMINC.com for more information.

Where safety devices are integral to the coupling, they must be working and utilized. The use of supplementary safety devices such as safety clips or safety cables are recommended.

If any problem is detected, couplings must be removed from service immediately.

Dixon® is available to consult, train and recommend the proper selection and application of all fittings we sell. We strongly recommend that distributors and end users make use of Dixon® Testing and Recommendation Services. Call 877.963.4966 or click dixonvalve.com to learn more.

Kalrez® are registered trademarks of E.I. duPont Nemours and Company. Kalrez® and Viton® are registered trademarks of DuPont Dow Elastomers. Kamvalok® is a registered trademark of OPW Engineered Systems.

Dixon® Terminal Products

Through innovation, superior product design, and application expertise our objectives are to be the easiest company to do business within the Terminal market. We will maintain the best inventory levels and lead times in the industry while providing training and support before, during, and after the sale. The onsite training at the end user level will focus on high quality manufactured products that extend service life and minimize downtime.



Terminal Process

Various refined petroleum products are distributed through Terminals to either tanker truck, barge or rail car. Dixon® products are successfully utilized in many of these transfer applications, from dry disconnects and API couplers to rack cords and vapor recovery couplers.

Dixon® is the right connection!

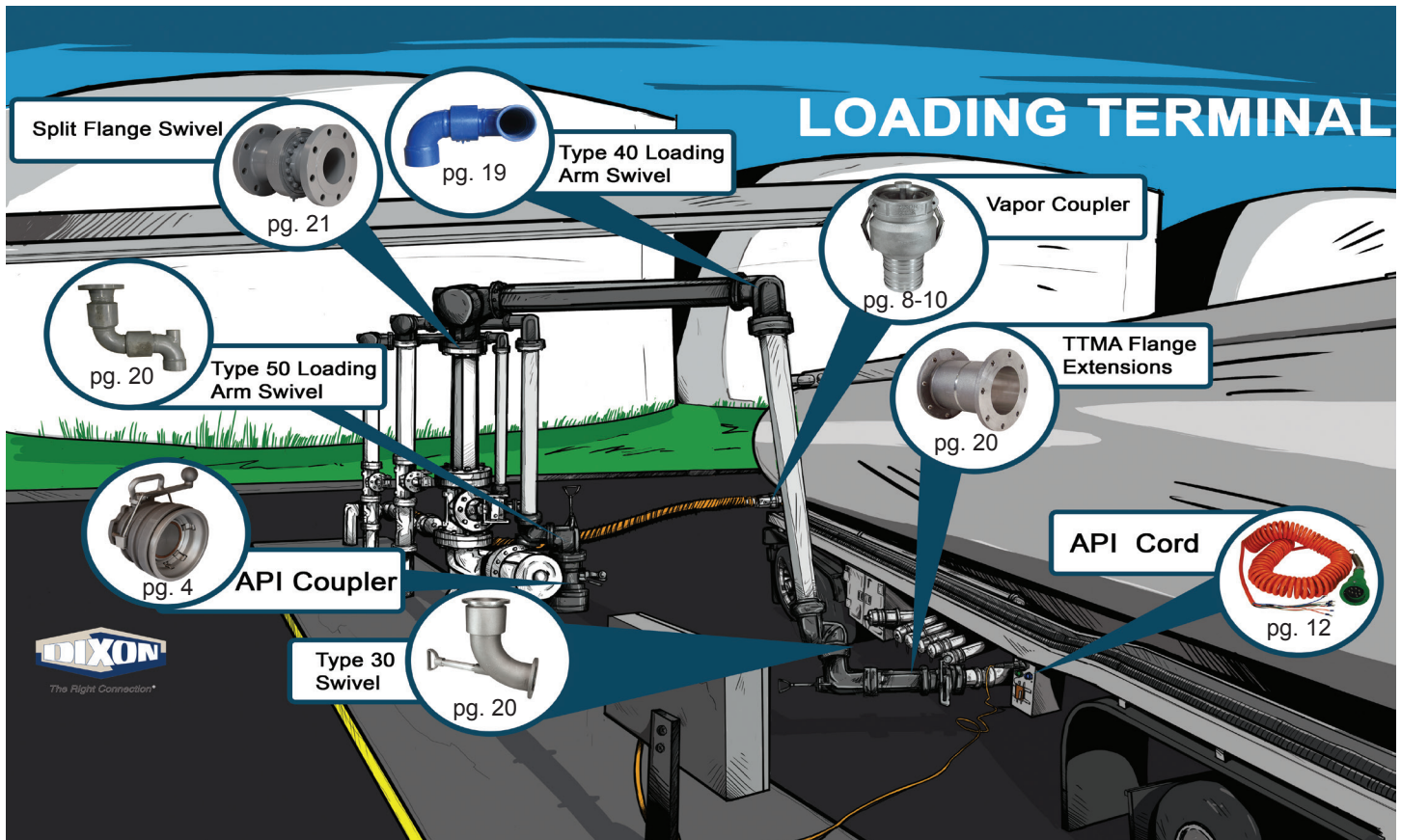

API Fittings - 5300/5400 Series

**NOW WITH
EXCLUSIVE
5 YEAR
MECHANICAL
WARRANTY***

* Normal wear & tear items (including seals) not covered

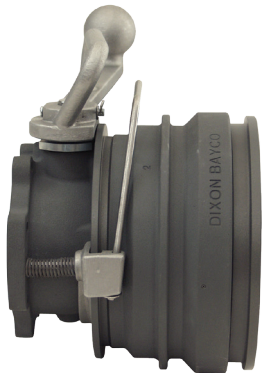

5300 series shown



(replaceable nose seal replaceable without removal from the loading arm)



(bonded nose seal which offers long life and cannot be washed out)

Application:

- combined with API ADAPTERS, these couplers are suitable for rail car and tank truck loading or unloading

Materials:

- body: hard coated anodized 356T6 aluminum
- shroud: hard coated anodized 356T6 aluminum with stainless steel insert
- link, shaft, pin and crank: hardened 17-4PH stainless steel
- cam: CF8M stainless steel
- poppet and bearing: Bayloy
- seals: Buna, FKM-B, FKM-GFLT

Features:

- locking 5 cam design provides easy alignment and tight connection
- modular design allows various face seal combinations to be compatible with different alternative fuels, performance levels and applications
- shaft seals can be changed without removing coupler from loading arm
- fully interlocked collar cannot be opened when connected and cannot be disconnected when opened
- choice of a bonded nose seal, or a replaceable nose seal which allows quick seal replacement
- 4" TTMA inlet mounting flange connection
- maximum flow rate: 600 GPM
- ball-end handle for easy, comfortable operation
- no special tools needed for maintenance
- Chemical Compatibility (FKM-B seals):
 - gasoline
 - diesel
 - jet fuel
 - avgas
 - 100% ethanol
 - 100% methanol
 - 100% biodiesel
 - any blend of the above fluids
 - crude oil
- Chemical Compatibility (Buna seals):
 - gasoline
 - diesel
 - avgas
 - 100% ethanol
 - 100% methanol
 - B2 to B20 biodiesel blends

Specifications:

- operating temperature:
 - FKM-B: -10°F to 400°F (-23°C to 204°C), FKM-GFLT: -20°F to 400°F (-28°C to 204°C), Buna seals: -20°F to 250°F (-28°C to 121°C)
- pressure drop: 3 to 4 PSI

Standard:

- fully compliant with API RP1004:2003 specifications

Size	Seal Material	Bonded Nose Seal Part #	Maximum Working Pressure	Replaceable Nose Seal Part #	Maximum Working Pressure
4"	Buna	5300	150	5400	75
	FKM-B	5300B	150	5400B	75
	FKM-GFLT	5300G	100	5400G	75
	FKM-B	5300BC ¹	150	---	--

¹ designed for high sulfur crude oil service

- Reference the Dixon Bayco Petroleum and Overfill catalog for bill of materials and complete list of repair kits.

repair kits

Description	Part #
Buna shaft seal kit (for 5300 and 5400)	5354K1
FKM-B shaft seal kit (for 5300B and 5400B)	5354K3
Bonded buna nose seal (for 5300)	5354K7
Bonded FKM-B nose seal (for 5300B)	5354K9
Buna replaceable nose seal kit (for 5400)	5354K13
FKM-B replaceable nose seal kit (5400B)	5354K15

Dry Gas

Applications:

- The primary application for dry gas couplings is in the handling of LPG - Propane and Butane. Also designed for safe loading and discharge of bobtails or intermediate bulk delivery trucks and transfer to and from rail cars.

Materials:

- stainless steel and brass / gunmetal (*produced to US government bronze specification G*)
- composite (Polyeten PE-HD 300) plug provides protection in harsh environments
- FKM (FPM) seals

Features:

- reliable and easy to maintain
- one piece adapter
- minimizes the risk of cold burns
- minimizes spillage and product loss
- minimizes health risks
- keeps the environment free of hazardous vapors and liquids
- compatible with existing dry disconnect couplings
- Quick and easy to connect, can be connected to a tank unit with pressures up to **225 PSI** at ambient temperature **70°F (21°C)**. If the pressure is higher you can equip the couplings with a pressure relief valve. The easy to connect pressure relief valve dissipates trapped fluid pressure into the hose coupler without spillage.

Specifications:

- can be coupled to a tank unit with pressures up to **225 PSI**
- working pressure: **360 PSI** at ambient temperature **70°F (21°C)**
- female NPT, female ACME and ASA flanges

Coupler - Hose Unit

coupler x female NPT with FKM (FPM) seals

Female NPT	Body Size	316 Stainless Steel Part #
2"	71 mm	DGC200SS



Adapter - Tank Unit

adapter x female ACME with FKM (FPM) seals

Female ACME	Body Size	316 Stainless Steel Part #
3/4"	71 mm	DGA200SS325

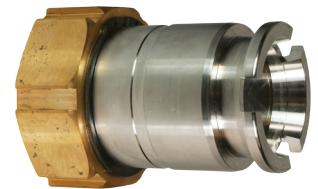

Mann-Tek Style



3" coupler pictured



Application:

- applications where it is important to minimize product loss when connecting / disconnecting hose assemblies

Materials:

- aluminum, brass / gunmetal or stainless steel

Features:

- no need to drain hoses or pipe systems
- no loss or spillage of liquids at connection or disconnection
- valve cannot be opened until the unit is coupled
- safe and reliable due to rugged construction
- produced according to NATO, standards STANAG 3756 and ATOFINA SGM 2049.TUY.C
- compatible with Mann-Tek, and Todo-matic® and other products produced according to NATO, standards STANAG 3756
- working pressure:
 - aluminum: **230 PSI** up to 4"
 - brass/ gunmetal : **230 PSI** up to 4"
 - stainless steel: **360 PSI**

Seal Materials:

- EPDM, NBR - Buna / Nitrile, Kalrez®, Chemraz®, FKM

Sizes:

- ¾", 1", 1½", 2", 3", 4" and 6"

Bayloc™ Cam and Groove Style

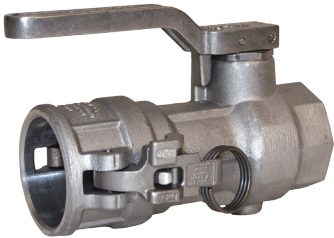

straight configuration coupler



DBA adapter

Application:

- helps prevent spillage from normal or accidental disconnects

Materials:

- stainless steel or aluminum
- call Dixon® for information on chemical compatibility, size, material selection and special configurations

Features:

- compatible with most cam and groove style dry disconnects
- spring loaded sealing device "snaps" closed should the coupling become disconnected with the poppet open
- two-piece adapter design allows easy rebuilding of adapters
- EZ Boss-Lock™ cam arms provide security against accidental opening
- automatic closing poppet assembly
- stainless steel handle allows product exposure to corrosive chemicals or wash down service
- fully interchangeable with Kamvalok® style fittings

Seal Materials:

- NBR - Buna / Nitrile, FKM, PTFE, EPDM

Sizes:

- 1½", 2" and 3" female NPT adapters x 2", 2½" and 4" coupler and adapter
- 2", 2½" and 4" couplers / adapters x 2" and 3" flange

Bayonet Style

Applications:

- Dixon® BA and BS series bayonet dry disconnect fittings are designed for use in the fuel and lube oil service industry.

Materials:

- anodized aluminum coupler
- aluminum adapter
- brass adapter
- stainless steel adapter

Features:

- compatible with Emco Wheaton™ Dry Break
- the maximum pressure rating is **85 PSI at 70°F (21°C)**, for pressure ratings at other temperatures contact Dixon®
- for information on repair kits visit dixonvalve.com

Seal Materials:

- NBR - Buna / Nitrile, FKM

Sizes:

- 2" and 3"



coupler x straight female NPT
- BC62-200



coupler x 90° swivel female
NPT - BS62-200



adapter x female NPT
- BA32-200

VAPOR RECOVERY COUPLERS

Materials:

- coupler: aluminum
- seal: Buna N

Features:

- 'floating bridge' poppet design allows optimal flow
- machined hose shank ensures easier insertion into hose and better sealing
- durable, easy to couple stainless cam arms unlike brass
- big wings ensure contact with air interlock button on tanker helping prevent drive-offs
- change poppet seal without removing the coupler from the hose
- secure to hose with traditional band clamps or built in crimp collar
- 4" MNPT version allows for either cam and groove or threaded flange option



VR4040CS-AL



VR4030CS-SH



VR4040CS-4MNPT
(TTF4AL-4FT sold separately)



VR4030CS-AL45 & VR4040CS-AL45



VR4040CSB



VR4030-AL45



VR4040-AL45

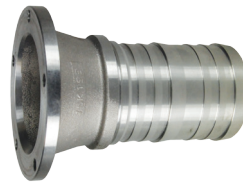

VR4030-AL

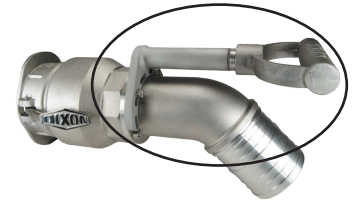

VRHK
(vapor recovery coupler handle kit
sold separately)



Heavy Duty
Stainless Steel
Handles

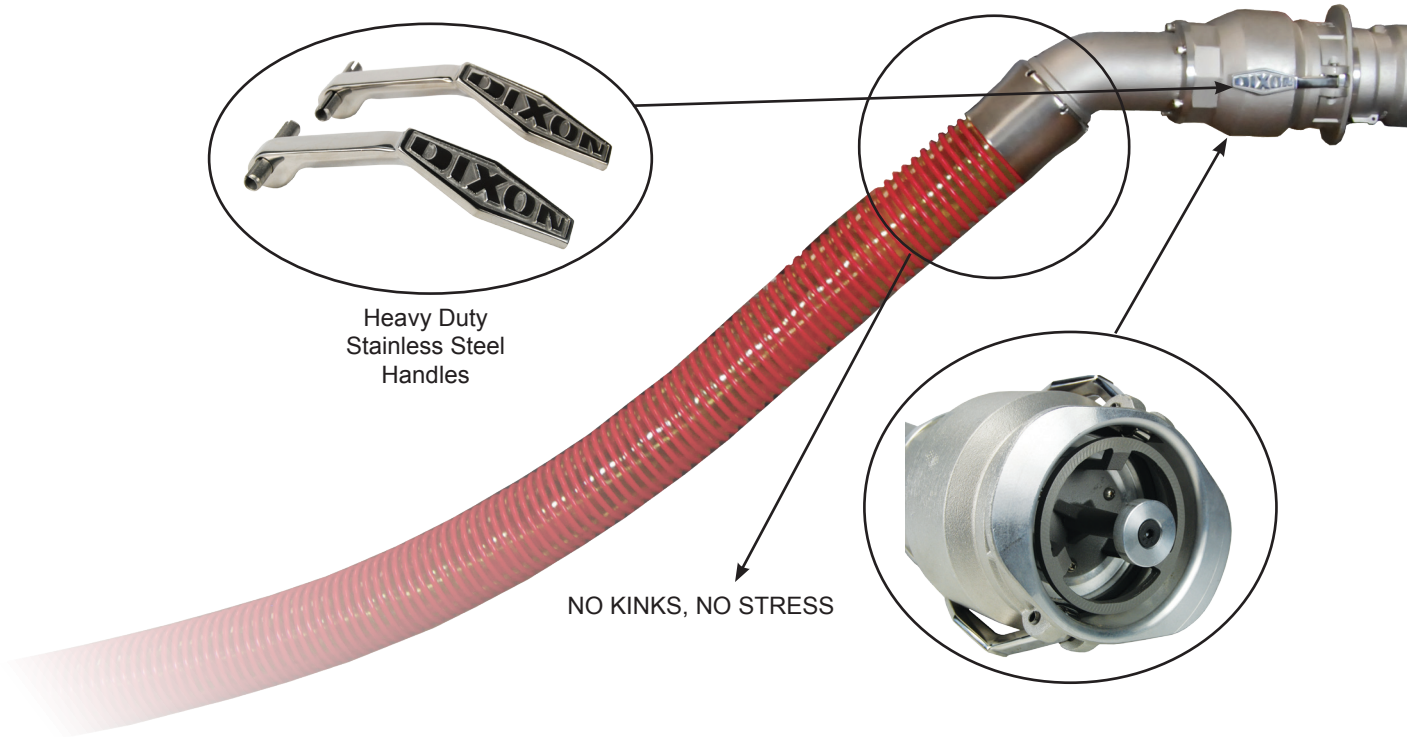

NO KINKS, NO STRESS

Vapor Recovery Repair Kits

Part #	Description
VR4040CSRK1	seal repair kit
VR4040CSRK2	cam arm repair kit
VR4040CSRK3	internal part kit
VR4040-AL45	4" x 45° hose shank kit
VR4030-AL45	3" x 45° hose shank kit
VR4040CSB	vapor coupler body complete kit
VR4040CSRK4	case repair
VR4030-AL	3" straight hose shank

VAPOR RECOVERY COUPLERS

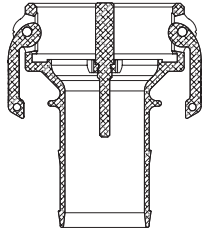

Materials:

- arms: bronze with stainless steel pins
- finger rings: plated carbon steel
- gasket: Buna-N

Features:

- not intended for liquid service, for vapor recovery *only*
- for use with vapor recovery hose



coupler with probe x hose shank

Coupler Size	Hose Shank Size	Aluminum Part #
4"	3"	4030-CVR-AL
4"	4"	400-CVR-AL

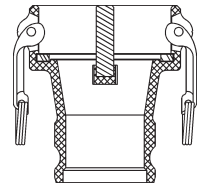

coupler with probe x adapter

Coupler Size	Adapter Size	Aluminum Part #
4"	3"	4030-DAVR-AL

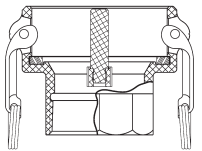

coupler with probe x female NPT

Coupler Size	Female NPT Size	Aluminum Part #
4"	3"	4030-DVR-AL
4"	4"	400-DVR-AL

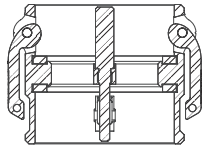

coupler with probe x coupler with probe

Coupler Size	Coupler Size	Aluminum Part #
4"	4"	400-DDVR-AL

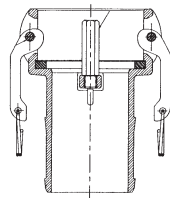

Materials:

- body: cast aluminum
- arms: bronze with stainless steel pins and finger rings
- gasket: Buna-N

Features:

- not intended for liquid service, for vapor recovery *only*
- for use with 3" vapor recovery hose
- VR4030CS-AL has a FKM O-ring poppet seal



coupler with probe x hose shank

Coupler Size	Hose Shank Size	Aluminum Part #
3"	3"	VRC3000AL

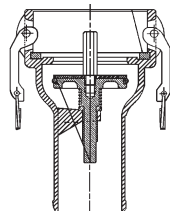

coupler with poppet and probe x hose shank

Coupler Size	Hose Shank Size	Aluminum Part #
4"	3"	VR4030CS-AL¹

¹ VR4030CS-AL will interchange with all competitor vapor valves *except* Civacon #633LVH (special bulb design).



Application:

- used on tank trucks to connect to vapor hose couplings

Size:

- 4"

Materials:

- bronze and ZN-AL alloy

Features:

- for use with dual point vapor elbows (VR6200 series)
- can also be used as vapor valve on tanker but does not have air interlock mount
- poppeted vapor collar at station vapor outlet
- low profile design
- replacement parts are available, contact Dixon® for more information



VR4086



VR4050AL



VR4050PL

Description	Part #
bronze vapor recovery tank adapter, 4" FNPT, 3 ⁵ / ₈ " height, with vapor poppet	VR4086
bayloy™ vapor recovery tank adapter, 4" FNPT, 3 ⁵ / ₈ " height, with vapor poppet	VR4086-BY
aluminum vapor recovery cap, colored vapor orange, push-pull T handle, buna gasket	VR4050AL
nylon vapor recovery cap, colored vapor orange, push-pull T handle, Buna gasket	VR4050PL
aluminum vapor recovery cap, colored vapor orange, push-pull T handle, Buna gasket, with chain	VR4050ALC
nylon vapor recovery cap, colored vapor orange, push-pull T handle, Buna gasket, with chain	VR4050PLC

Reference Dixon Bayco Petroleum and Overfill catalog for repair kits and replacement parts. Product instruction sheets and technical data can be viewed on our website at dixonvalve.com

API Compatible

Materials:

- plug body: reinforced nylon
- button contacts: 316 stainless steel to prevent corrosion
- all other hardware: stainless steel

Features:

- plug is color coded Optic Blue or Thermistor Green
- highly visible safety orange jacket to meet trip hazard requirements
- cord is bonded mechanically and resistant to abrasion and oil
- Cord sets are interchangeable with Scully and Civacon. All wiring is compatible with standard Scully color codes and wiring number configurations. The 9 pin conductor is shielded to be compatible with Scully VIP system.
- for mating socket consult Dixon®



FT590 Series Terminal Test Equipment



FT590OG

Application:

- Used to verify performance of terminal overfill monitors and read the Trailer Identification Modules (TIM).

Features:

- Rack monitor testers and mini trailer overfill system have the same API compatible signals.
- When connected to the API plug will cause the Terminal Overfill Monitor to switch permissive.
- Tester contains a liquid level sensors, API compatible socket, Ground bolt and TIM module all rewired into one unit.
- FloTech FT530 is a self contained microprocessor capable of reading the serial number embedded into the TIM located in the trailer socket. This tester will verify operation and display the unique serial number you need to enter into the terminal automation system.



FT590TG



FT530

Description	Part #
rack tester thermistor with ground bolt	FT590TG
rack tester thermistor with ground bolt and TIM	FT590TGT
rack tester optic with ground bolt	FT590OG
rack tester optic with ground bolt and TIM	FT590OGT
TIM reader	FT530

API RACK CORD CROSS REFERENCE CHART

API Rack Cord Assemblies

FloTech Part #	Civacon Part #	Scully Part #	API		Cord		J-Slots			Pins			Breakaway Plug	
			Thermistor "Green"	Optic "Blue"	20' Straight	30' Coiled	2	3	4	6	8	10	Optic "J560" Aluminum	Thermistor 13 Pin Plastic
FT600	7300SR-7300	21818	✓			✓	✓				✓			
FT600-4	---	---	✓			✓			✓		✓			
FT600C	7300CSR-7300	31092	✓			✓			✓			✓		
FT600C-2	7300C-7300	---	✓			✓	✓					✓		
FT600P	7320SR-7320	---	✓			✓	✓				✓			✓
FT600P-4	---	---	✓			✓			✓		✓			✓
FT600S	7300-STRAIGHT	20830	✓		✓		✓				✓			
FT600SC	7300C-STRAIGHT	---	✓		✓				✓			✓		
FT600CP	---	---	✓			✓			✓		✓			✓
FT600SP	---	---	✓					✓			✓			✓
FT605C	---	---		✓		✓			✓	✓				
FT620	7100SR-7100	21831		✓		✓		✓		✓				
FT620P	7100-J560	---		✓		✓		✓		✓			✓	
FT620X620	---	---		✓		✓		✓		✓				
FT620S	7100-STRAIGHT	21764		✓	✓			✓		✓				

API Rack Cord Parts

FloTech Part #	Description	API		Cord		J-Slots			Pins				
		Thermistor "Green"	Optic "Blue"	20' Straight	30' Coiled	2	3	4	6	8	10		
FT601	replacement green plug assembly, 2 J-slots, 8 pins	✓							✓			✓	
FT601-4	replacement green plug assembly, 4 J-slots, 8 pins	✓								✓		✓	
FT601-10	replacement green plug assembly, 4 J-slots, 10 pins	✓								✓			✓
FT602	replacement 30' coiled cord, Thermistor 10 conductor	✓					✓						
FT603	Thermistor plug storage hanger	✓								✓			
FT604	replacement 20' straight cord, Thermistor 10 conductor	✓				✓							
FT621	replacement blue plug assembly, 3 J-slots, 6 pins		✓							✓		✓	
FT622	replacement 30' coiled cord, optic 6 conductor		✓						✓				
FT623	optic plug storage hanger		✓							✓			
FT624	replacement 20' straight cord, optic 6 conductor		✓			✓							

Breaking Bolt Series

Marine Version



Size	Width	Length	Weight in Lbs.	Flow Rate/ GPM
2"	4.5"	7"	5.7	200
3"	6.8"	11"	18.8	650
4"	8.3"	12"	34.1	800
5"	10.6"	14"	71	1100
6"	12"	16"	101	1500
8"	13.5"	17.7"	157	3700

Applications:

- designed to minimize spillage and damage associated with pull-away incidents
- typical applications include: ship-to-offshore platform and ship-to-ship product transfer operations
- **designed to be installed within a hose string where the coupling will have a length of hose attached to both sides**

Materials:

- body: 316T1 stainless steel
- O-rings: FKM (FPM)

Features:

- coupling automatically senses an excessive load, closes the valves and disconnects, release is executed when force causes bolts to break
- optional non-closure design is available, contact Dixon®

Specification:

- working pressure: **360 PSI** at ambient temperature **70°F (21°C)**

150# Flange x 150# Flange



Size	DN Size	316 Stainless Steel Part #
2"	50	MSBC200SSFL
3"	80	MSBC300SSFL
4"	100	MSBC400SSFL
5"	125	MSBC500SSFL
6"	150	MSBC600SSFL
8"	200	MSBC800SSFL

How it Works

Safety break-away couplings have three external break bolts. In the case of axial tension all of the bolts take up the force corresponding to the break force on the hose with a safety margin. Non-axial forces concentrate the tension forces more strongly on one bolt, so that the safety break-away coupling reacts in a natural way to the reduction of the hose break forces.

A tanker barge unloads by using 2, 8" dock hoses using 2, 3500 gpm pumps. If the tide switches and causes the barge to shift and the hose to pull away, 7000 gpm spills. How fast can the nearby operator close the 8" gate valves 1 minute, 5 minutes or 10 minutes? Having a Dixon® marine safety break-away ensures less than 1 gallon of product will be spilled.

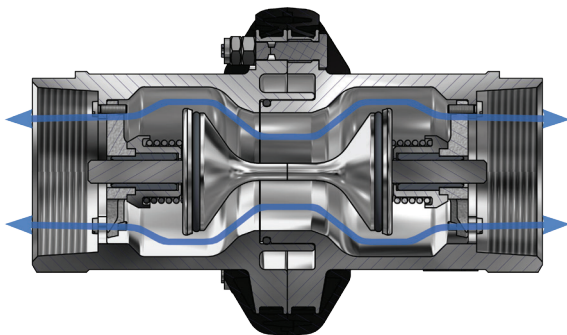

BEFORE emergency disconnect

The safety break-away valve consists of two halves, each with a valve that has a O-ring seal.

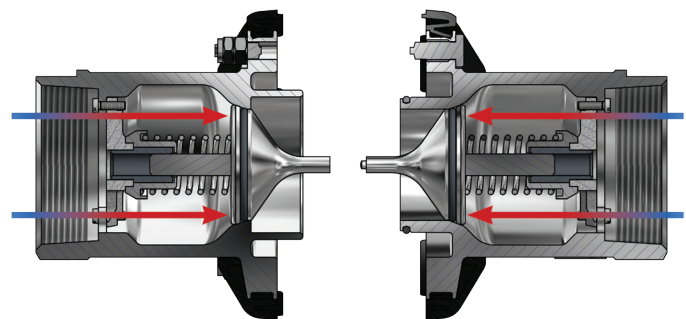

AFTER emergency disconnect

When the safety break-away couplings separate, it allows the valves to close. The two valves close rapidly, minimizing exposure to personnel and the environment.

Industrial Version

Applications:

- designed to minimize spillage and damage associated with pull-away incidents
- typical applications: loading rack
- **designed to be installed between a fixed point (pipe, pump, manifold) and a hose**



Features:

- coupling automatically senses an excessive load, closes the valves and disconnects
- high flow rate / low pressure drop
- FKM (FPM) is standard seal
- optional non-disclosure design is available, contact Dixon®

Size	Width	Length	Weight in Lbs.	Flow Rate/ GPM
4"	8.3"	12"	14	800

Specifications:

- working pressure: stainless steel **360 PSI** and aluminum **230 PSI** at ambient temperature **70°F (21°C)**

TTMA Flanged Breakaway Coupling

Application:

- installs between an API coupler and loading arm

Features:

- minimizes spillage and damage associated with drive away and pull away incidents
- coupling automatically senses excessive load, closes the valves and disconnects
- high flow rate / low pressure drop
- FKM/FPM is standard seal

Specification:

- **230 PSI** at ambient temperature **70°F (21°C)**



Size	Aluminum Part #
4"	SBC400ALTTMA

Products in use at a Facility

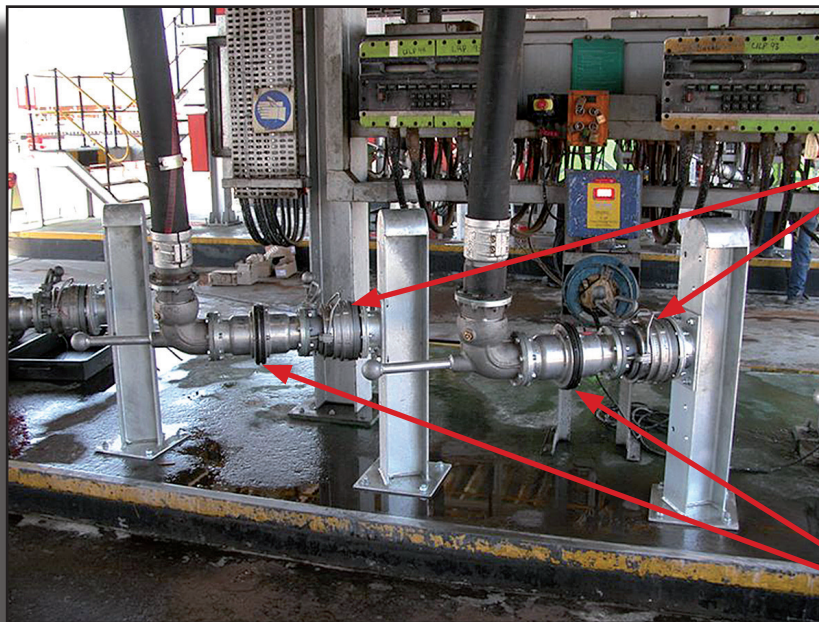

API couplers

Safety breakaway couplings

TTMA Series Flange Adapters

Features:

- simply and easily converts threaded components to a standard TTMA flange configuration
- solid cast lightweight aluminum design is more durable than welded fabrications
- design improves flow through adapter
- compact size reduces the overall space needed to install

Male Threaded

TTMA flange x standard male NPT



TTMA Flange	Male NPT	Overall Length	Aluminum Part #
3"	3"	2½"	TTF3AL-3MT
4"	3"	2½"	TTF4AL-3MT
4"	4"	2½"	TTF4AL-4MT

Extended Length - Male Threaded

TTMA flange x extended length male NPT

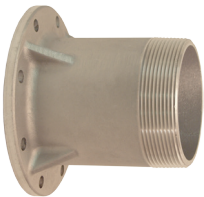

TTMA Flange	Male NPT	Overall Length	Aluminum Part #
4"	3"	5½"	TTF4AL-3EMT
4"	4"	5½"	TTF4AL-4EMT

Female Threaded

TTMA flange x female NPT



TTMA Flange	Female NPT	Overall Length	Aluminum Part #
4"	3"	2½"	TTF4AL-3FT
4"	4"	2½"	TTF4AL-4FT

Slip-on

TTMA flange x socket weld



TTMA Flange	Pipe Size	Aluminum Part #
4"	4"	TTF400SP

Round Tank Truck Flange Gaskets (TTMA)

Size	OD	ID	THK	Material	Part #
3"	5 ⁵ / ₈ "	3 ¹ / ₂ "	1 ¹ / ₈ "	Cork / Buna	300GTTFCB
3"	5 ⁵ / ₈ "	3 ¹ / ₂ "	1/16"	PTFE envelope with Klinger filler	300GTTFTK
3"	5 ⁵ / ₈ "	3 ¹ / ₂ "	1 ¹ / ₈ "	Klingersil® C-4401	300GTTFK
3"	5 ⁵ / ₈ "	3 ⁵ / ₈ "	1 ¹ / ₈ "	Baylast™	300GTTFBL
3"	5 ⁵ / ₈ "	3 ¹ / ₂ "	1/4"	PTFE with fiber core	40321TF
4"	6 ⁵ / ₈ "	4-9/16"	1 ¹ / ₈ "	Cork / Buna	400GTTFCB
4"	6 ⁵ / ₈ "	4-9/16"	1/16"	PTFE envelope with Klinger filler	400GTTFTK
4"	6 ⁵ / ₈ "	4-9/16"	1 ¹ / ₈ "	Klingersil® C-4401	400GTTFK
4"	6 ⁵ / ₈ "	4 ⁷ / ₈ "	1 ¹ / ₈ "	Baylast™	400GTTFBL
4"	6 ⁵ / ₈ "	4-9/16"	1/4"	PTFE with fiber core	40322TF



Betts Wet-R-Dri™ Valve

Application:

- Designed for handling liquid, gaseous or dry products

Features:

- Has a positive stop in the open and closed position
- Detent spring and ball assist in holding the disc in the open and closed position

Size	Description	Part #
3"	TTMA Wet-R-Dri™ valve manually operated detent handle	WD301ALVB
3"	TTMA Wet-R-Dri™ valve manually operated metering handle	WD304ALVB
4"	TTMA Wet-R-Dri™ valve manually operated detent handle	WD401ALVB
4"	TTMA Wet-R-Dri™ valve manually operated metering handle	WD404ALVB



TTMA Flange Screen

Materials:

- stainless steel screen is encapsulated in an FKM gasket

Size	Description	Stainless Steel Part #
4"	screen with 1" square holes	TTFS4SS

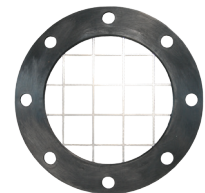

TTMA Sight Flow Indicators

Features:

- Due to the proprietary blending of petroleum products, Dixon® recommends that the thermoplastic tubing and the gaskets be immersion tested in the product to be handled to ensure compatibility (not compatible with crude oil).
- for tank truck flange gaskets go to dixonvalve.com
- tank truck flange dimensional information at dixonvalve.com



Specification:

- maximum flange bolt torque is 200 in-lb (inch pounds)



TTMA pattern flanged acrylic sight flow indicators

Size	Nominal Width	Acrylic Part #
3"	1 ³ / ₄ "	TT3ASG-ETH ¹
4"	1 ³ / ₄ "	TT4ASG-ETH ¹

¹ for use with ethanol

TTMA pattern flanged short sight flow indicators

Features:

- allows for visual identification of the fuel grade prior to opening the valve
- works with tank truck flanged butterfly valves found on gasoline trucks
- low cost sight glass tube can be easily replaced
- durable cast aluminum housing replaces competitions all acrylic sight glass



Size	Width	Aluminum Part #
4"	1 ³ / ₄ "	5200-SFI

sight flow indicator with 4³/₈" flow

Features:

- allows for visual identification of the fuel grade prior to opening the valve
- works with tank truck flanged butterfly valves found on gasoline trucks
- larger ID 4³/₈" flow indicator allows tank truck flanged butterfly valves to connect to either end of the indicator



Specification:

- rated to **150 PSI**

Size	Width	Aluminum Part #	Opt Qty
4"	3 ¹ / ₄ "	5201-SFI	5

replacement parts

Description	Used on	Part #
replacement Baylast™ O-rings, sight glass & retaining ring	5201-SFI	5201-SFI-RK1
Buna-N O-ring		O249BU

sight flow indicator with 4" flow

Features:

- allows for visual identification of the fuel grade prior to opening the valve
- 4" flow diameter



Size	Aluminum Part #	Opt Qty
4"	4-1460-AL	10

replacement parts

Description	Part #	Opt Qty
plexiglass insert	4PSG	10
Buna-N O-ring	O246BU	10

Low Pressure Swivels



Applications:

- used wherever a leak-proof swivel connection is needed in pipelines or in combination with hoses to eliminate hose twisting
- Industries range from petroleum, petrochemical, refining, mining, distilling, paint, farm irrigation and fertilizing, wastewater treatment plants and food and beverage process equipment. Dixon®'s swivel joints are found in blending plants, drum filling applications, fluid and dry bulk transfer, vacuum trucks, oil and gas trucks and water trucks. Larger swivels can be found in the steel industry, marine bulk transfer and many more.

Materials:

- seal options: Buna, FKM, PTFE, EPDM, FDA Buna, FFKM
- ball bearing materials: carbon steel, 440 stainless steel, and 316 stainless steel
- grease materials: Lithium, FDA approved/food grade and silicone

Features:

- full 360° rotational movement
- wide spacing between dual ball bearing raceways ensures greater load bearing capacity
- precision-machined design ensures alignment and years of trouble-free service
- O-ring dust seal protects the ball races and seals chamber from outside elements
- radius elbow design ensures a smooth flow pattern
- hydrostatic testing is performed on all swivels before shipment
- re-build kits available

Specifications:

- end configurations: female NPT, 150# flanges, TTMA flange, grooved, weld end and many other variations
- swivels that include oxygen, steam or submerged service can be specifically designed for unique applications (special order)
- 100% full penetration weld
- custom swivel options available, contact Dixon® at 888.226.4673

Swivel configurator available on dixonvalve.com

Typical Applications

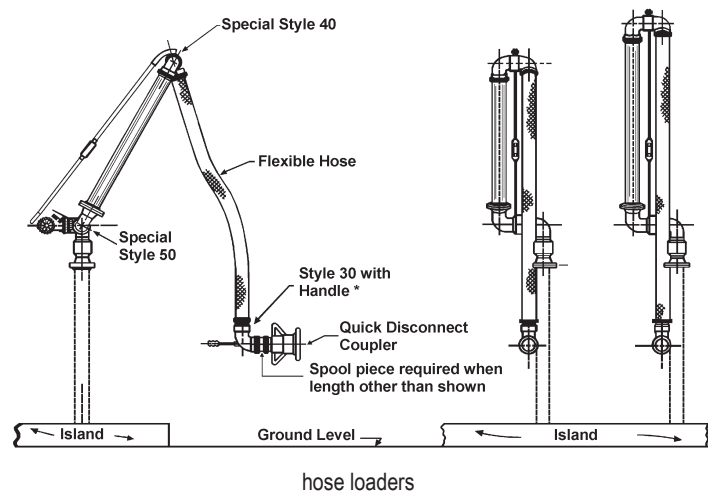
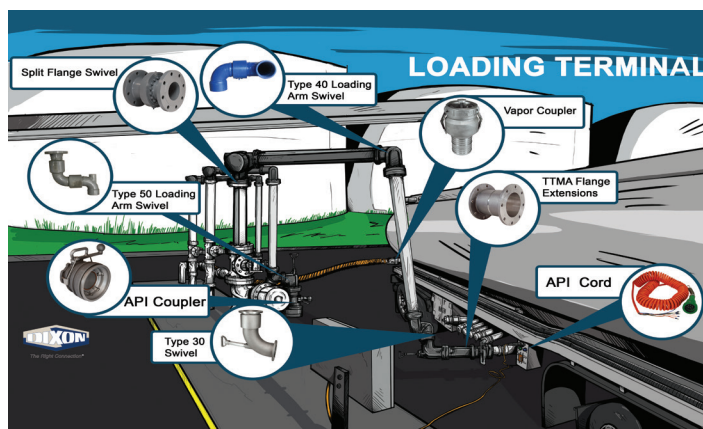

TTMA Flange Extensions



TETF4AL



TETFG4AL

Application:

- Used on load arms to connect an API load coupler to the load arm, provides a specified parting point to prevent excessive damage to the loading arm.

Feature:

- adds a 6" space between the load arm and the tank truck

Size	Description	Aluminum Part #
4"	TTMA flange extension	TETF4AL
4"	TTMA flange extension with groove	TETFG4AL

Loading Arm Swivels

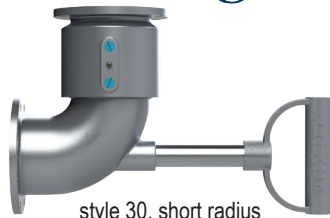

style 30, short radius

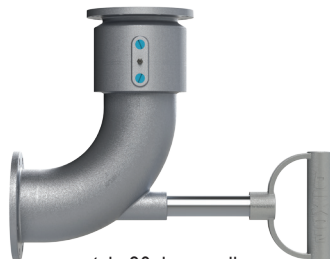

style 30, long radius

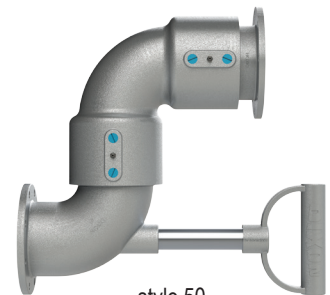

style 50

Features:

- TTMA loading arm swivel with heavy duty D style shovel handle
- shovel handle is used to guide the API load coupler onto the adapter on the tank truck
- long radius elbow improves the flow into the API load coupler and provides spacing between the load arm and the tank truck
- FKM swivel seals are compatible with ethanol blended fuel

Specifications:

- can be used with flange extensions above
- TTMA flanges on both ends

Size	Description	Aluminum Part #
4"	Style 30 short radius, with handle, TTMA x TTMA flanges w/ Buna seals	43HTFXTFAL00000
4"	Style 30 short radius, with handle, TTMA x TTMA flanges w/ FKM seals	43HTFXTFAL11000
4"	Style 30 short radius, without handle, TTMA x TTMA flanges w/ Buna seals	430TFXTFAL00000
4"	Style 30 short radius, without handle, TTMA x TTMA flanges w/ FKM seals	430TFXTFAL11000
4"	Style 30 long radius, with handle, TTMA x TTMA flanges w/ Buna seals	43HTFTFLAL00000
4"	Style 30 long radius, with handle, TTMA x TTMA flanges w/ FKM seals	43HTFTFLAL11000
4"	Style 30 long radius, without handle, TTMA x TTMA flanges w/ Buna seals	430FTFLAL00000
4"	Style 30 long radius, without handle, TTMA x TTMA flanges w/ FKM seals	430FTFLAL11000
4"	Style 50 with handle, TTMA x TTMA flanges w/ Buna seals	45HTFXTFAL00000
4"	Style 50 with handle, TTMA x TTMA flanges w/ FKM seals	45HTFXTFAL11000
4"	Style 50 without handle, TTMA x TTMA flanges w/ Buna seals	450TFXTFAL00000
4"	Style 50 without handle, TTMA x TTMA flanges w/ FKM seals	450TFXTFAL11000

Type 35 Loading Arm Swivel Replacement Parts

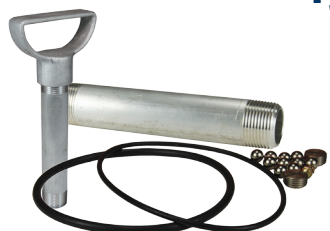

Description	Part #
4" schedule 80 aluminum nipple	ATN100X7
D style heavy duty shovel handle	100DHAN-AL
buna seal kit	4RKOBU
FKM seal kit	4RKOVIVI

Split Flange Swivels

Applications:

- For use in industries from petroleum, blending plants, petrochemical, refining, mining, distilling, paint plants, farm irrigation and fertilizing, wastewater treatment, food and beverage process equipment, marine and many more

Sizes:

- 2", 3" and 4"

Materials:

- bearing pack: through hardened forged high carbon alloy
- material contact surfaces: stainless steel or carbon steel nose pieces

Features:

- Bearing pack design allows easy seal change without removing the ball bearings.
- Simple maintenance: remove one nose piece, replace seal pack, and reinstall with little down-time.
- Instream seal separates the wetted area from the ball bearings allowing for longer bearing pack life over conventional swivels.
- wide set bearing race for higher moment loads
- compact design for low profile applications

Specifications:

- pressure rating: up to **600 PSI**
- temperature: **-40°F to 450°F (-40°C to 232°C)** depending on seal material with standard seals: **350°F (176°C)**
- all styles
- stock end configurations: 150 lb. and 300 lb. flanges, FNPT, butt weld, others per request
- stock seals: Baylast™, FKM, PTFE, others per request
- full penetration weld

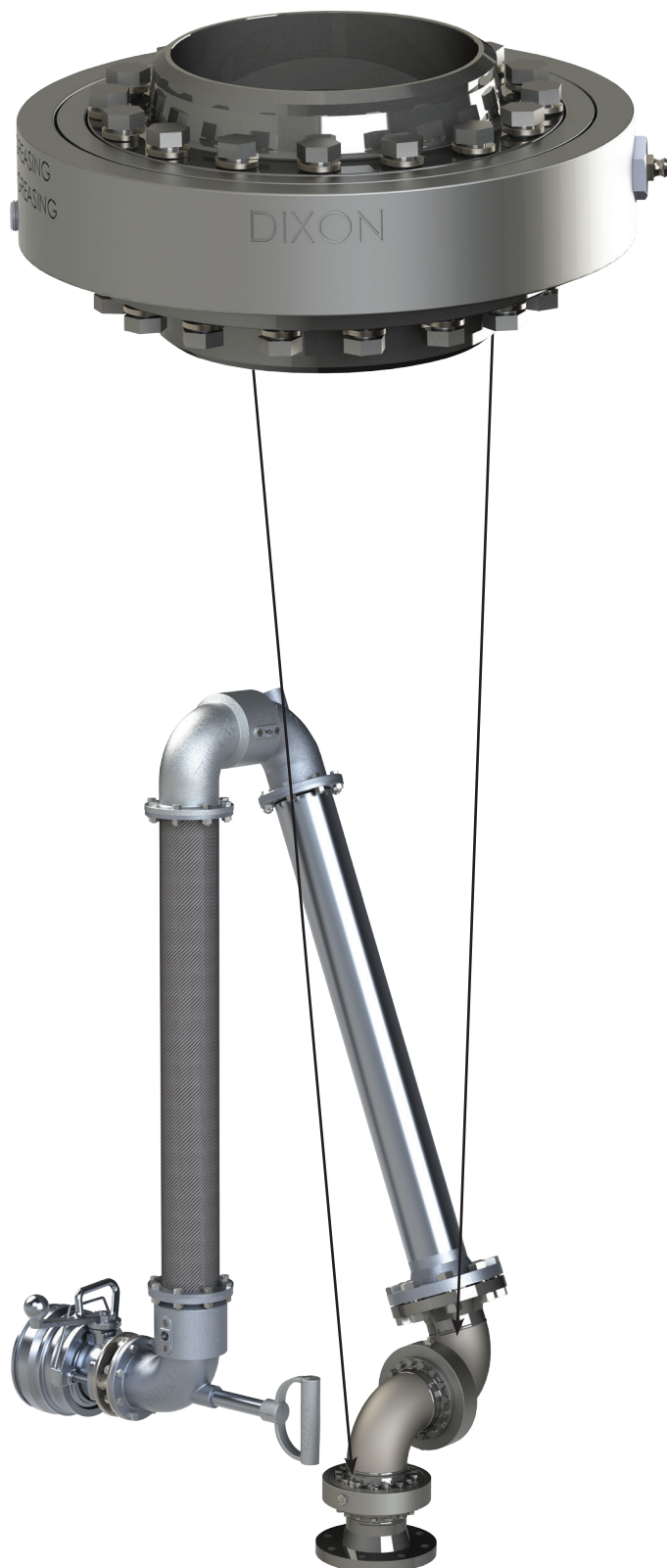
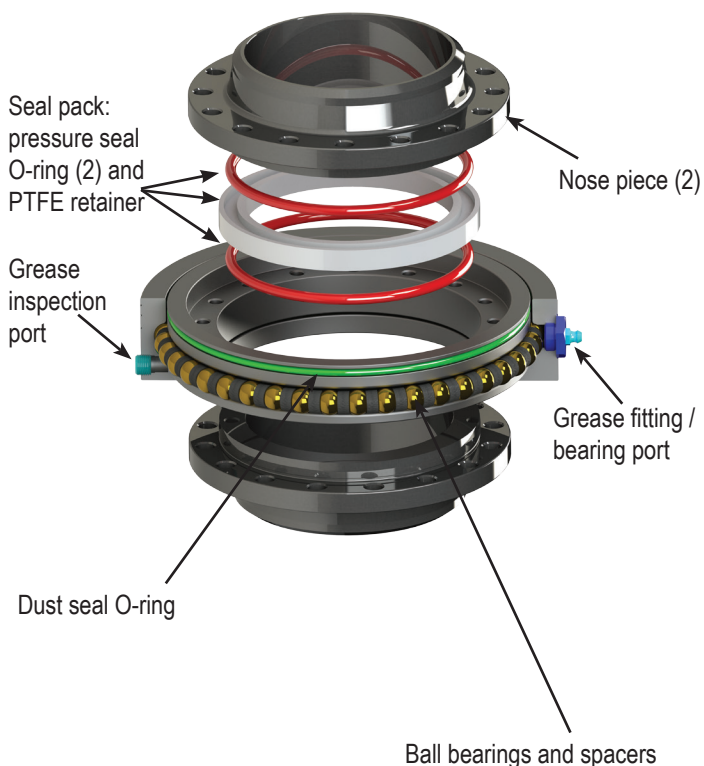



TRANSPORTATION



REFINING



TRANSPOR

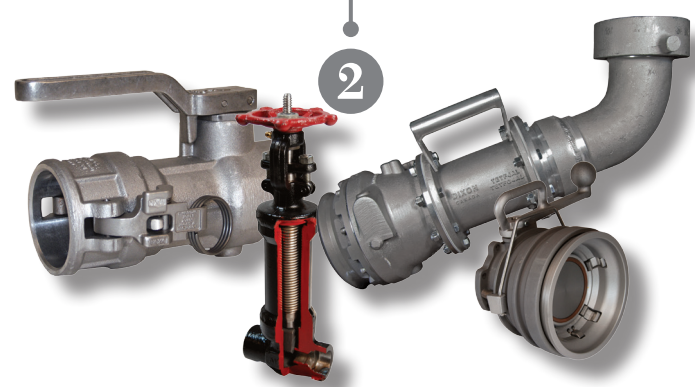

Exploration and Production

- Boss™ Low Pressure System Products
- Frac Fittings
- King Crimp™ System
- Hammer Unions
- Control Valves
- Holedall™ Couplings
- Tank Truck and Rail Car/API Fittings & Assemblies

Refining

- Dry Break Couplings
- Cam & Groove
- Dry Disconnects
- Ground Joint Systems
- Valves
- API Fittings

PETROCHEMICAL LIFE CYCLE

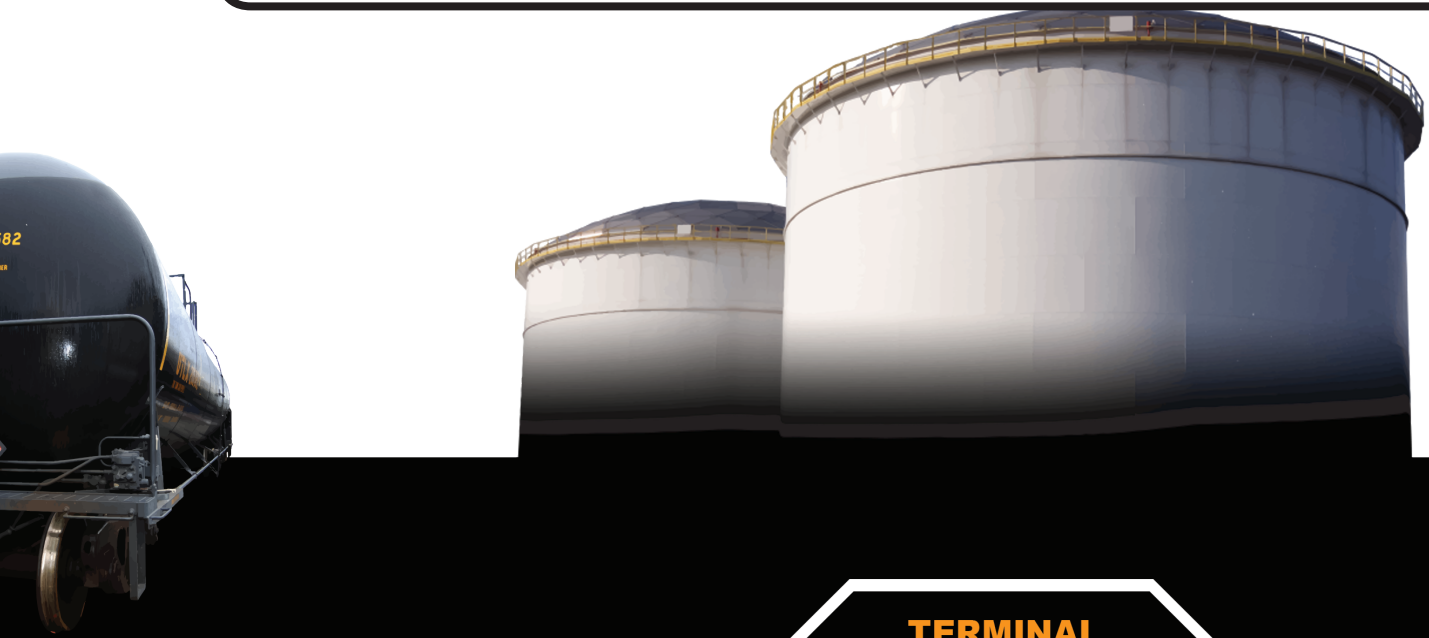

TERMINAL

TRANSPORTATION



Terminal

- Overfill Protection
- Loading/Unloading
- Safety Break-away
- Swivels
- Tank Truck and Rack Fittings
- Split Flange Swivel



Scan for more information on the petrochemical life cycle

Dixon®, founded in 1916, is a premier manufacturer and supplier of hose couplings, valves, dry-disconnects, swivels, and other fluid transfer and control products. The company's global reach includes a wide range of products for numerous industries including petroleum exploration, refining, transportation, chemical processing, food & beverage, steel, fire protection, construction, mining and manufacturing. Dixon®'s strategic objective is to create solutions that make products safer, leak-free, longer lasting, and always available.

dixonvalve.com • *Customer Service: 877.963.4966*



The Right Connection®

Dixon®

800 High Street, Chestertown, MD 21620
Fax: 800.283.4966



Dixon®
Customer Service

