

**TOP VIEW**

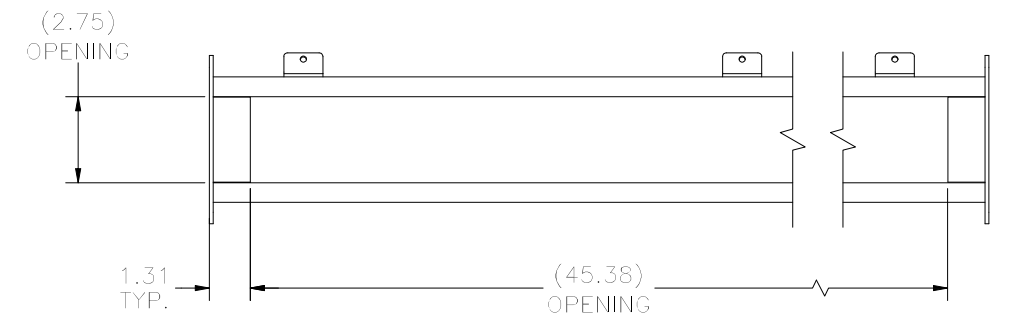

**TOP VIEW (LID ASSM. NOT SHOWN)**

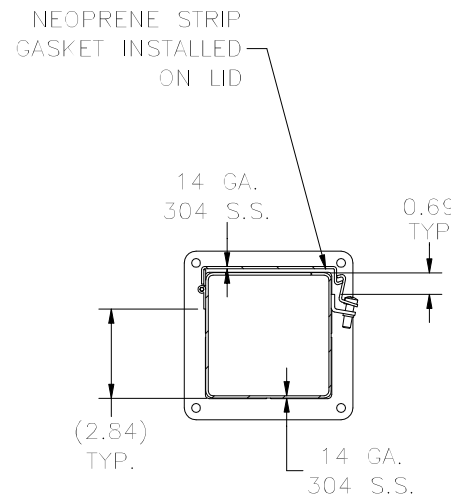

**SECTION A-A VIEW**

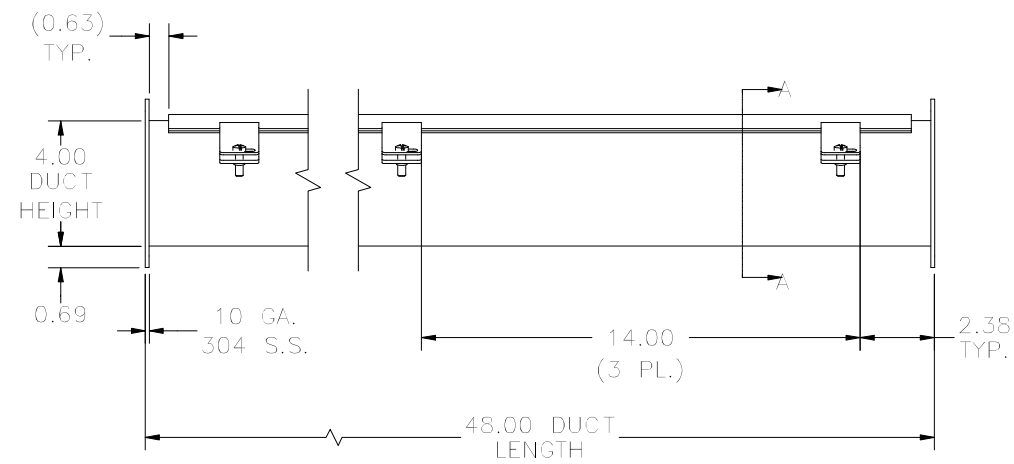

**FRONT VIEW**

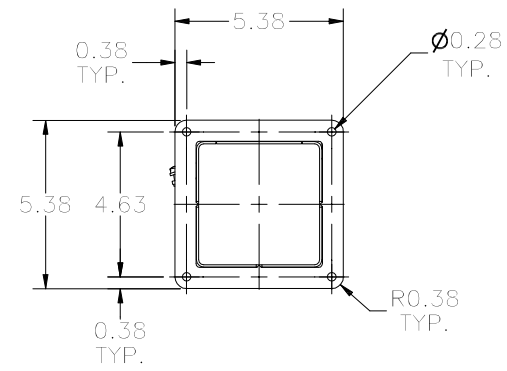

**RIGHT SIDE VIEW**

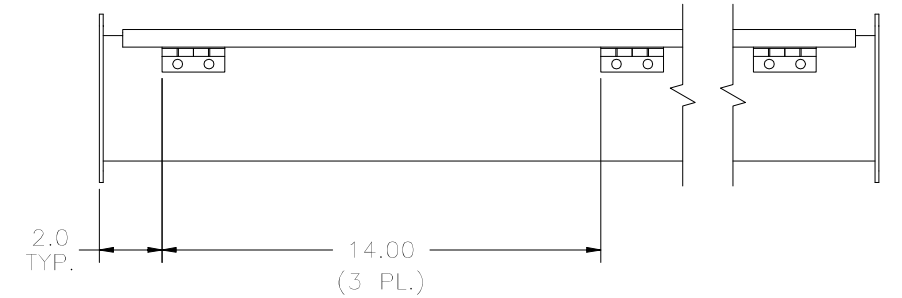

**REAR VIEW**

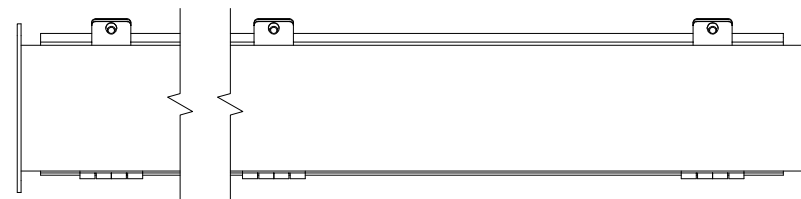

**BOTTOM VIEW**

PART#: SSJW44  
 (DATA SUBJECT TO CHANGE WITHOUT NOTICE)

THIS DRAWING IS PROPERTY OF HUBBELL INC. WEIGMANN  
 ALL INFORMATION IS PROPRIETARY AND NOT TO BE DUPLICATED

