

**TOP VIEW
(COVER REMOVED)**

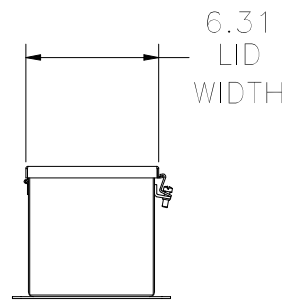

LEFT SIDE VIEW

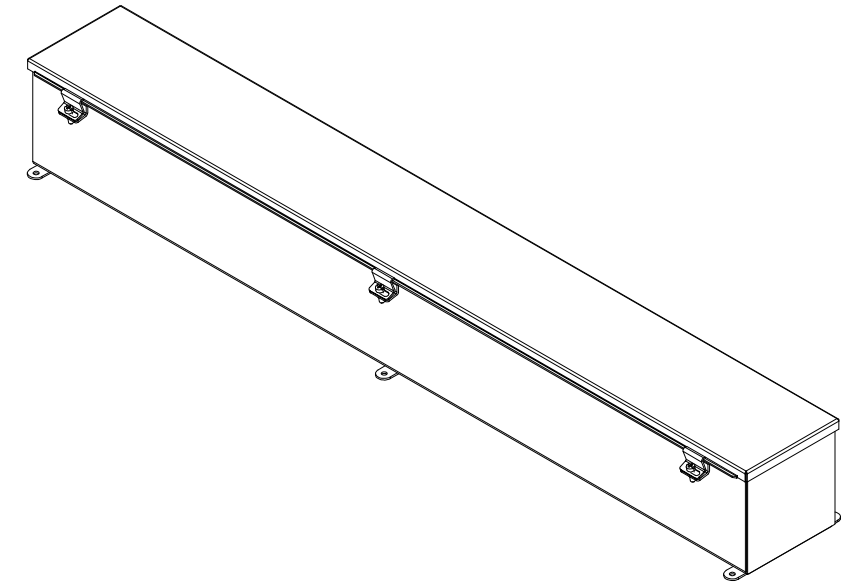
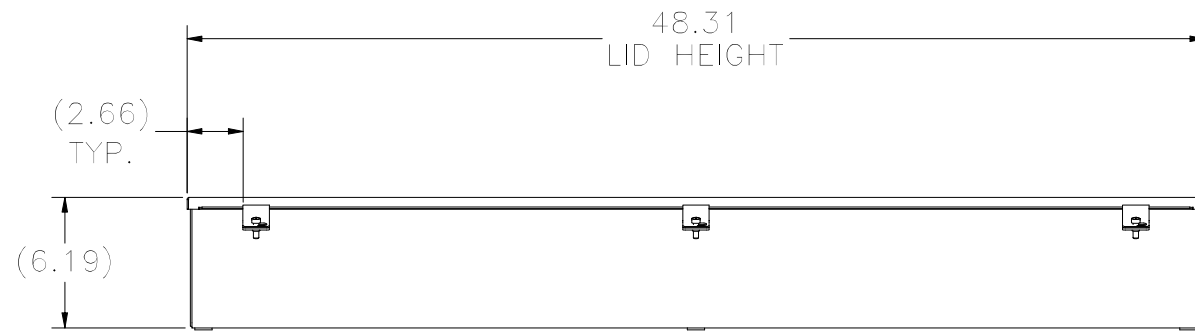

FRONT VIEW

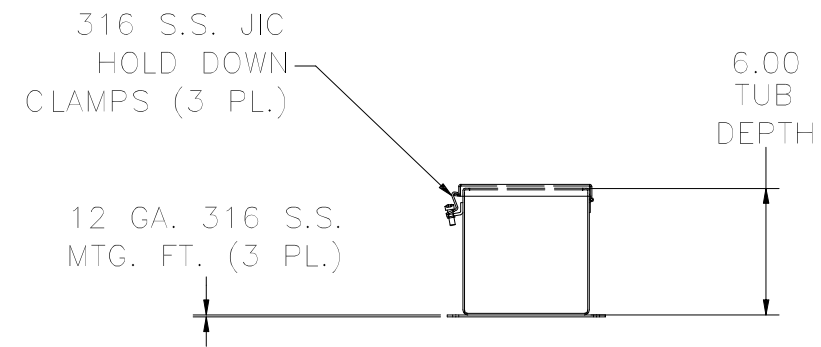

RIGHT SIDE VIEW

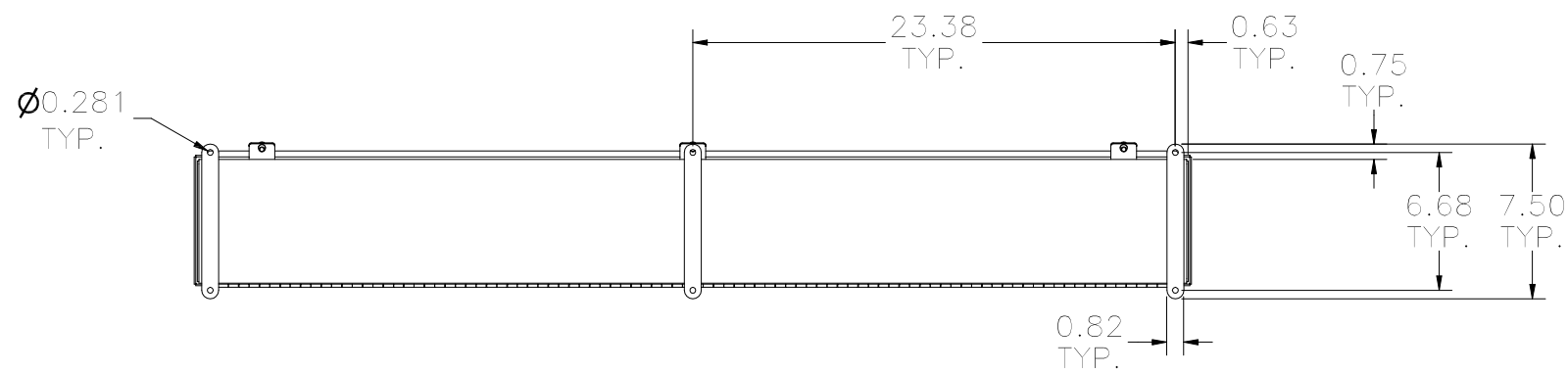

BOTTOM VIEW

PART#: T6648CH
(DATA SUBJECT TO CHANGE WITHOUT NOTICE)

THIS DRAWING IS PROPERTY OF HUBBELL INC. WIEGMANN
ALL INFORMATION IS PROPRIETARY AND NOT TO BE DUPLICATED