

TOP VIEW

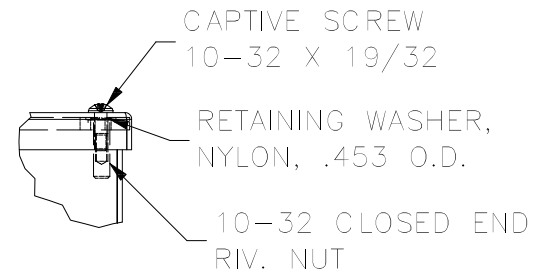

**DETAIL N
(2 PL.)**

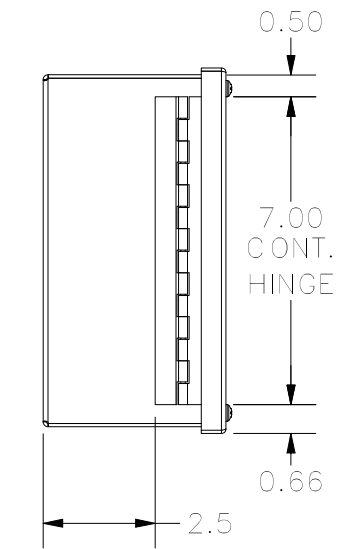
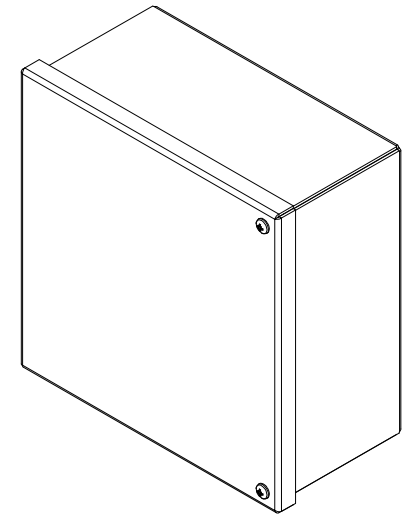

LEFT SIDE VIEW

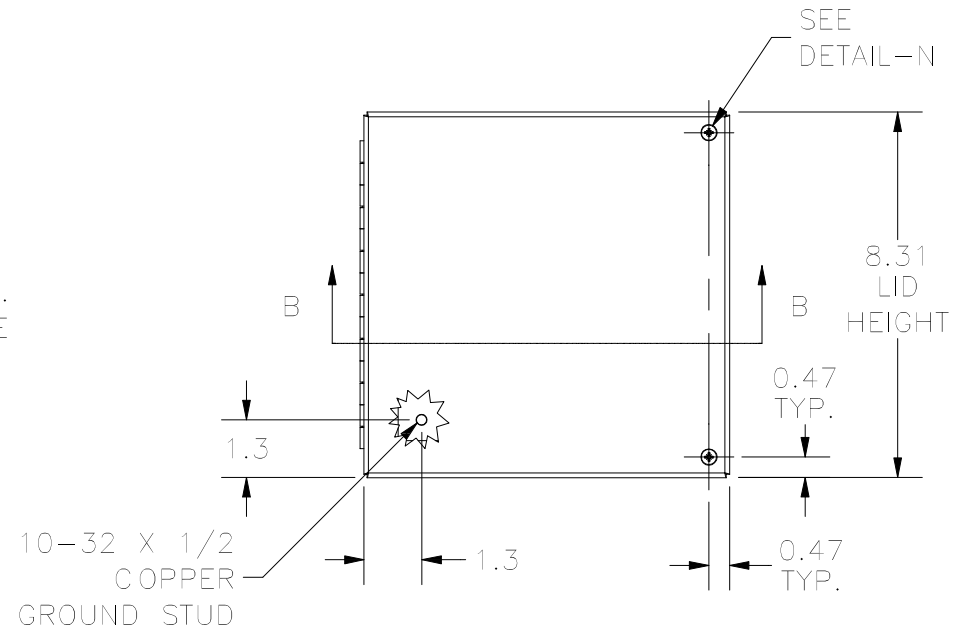

FRONT VIEW

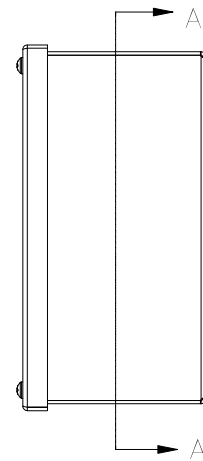

RIGHT SIDE VIEW

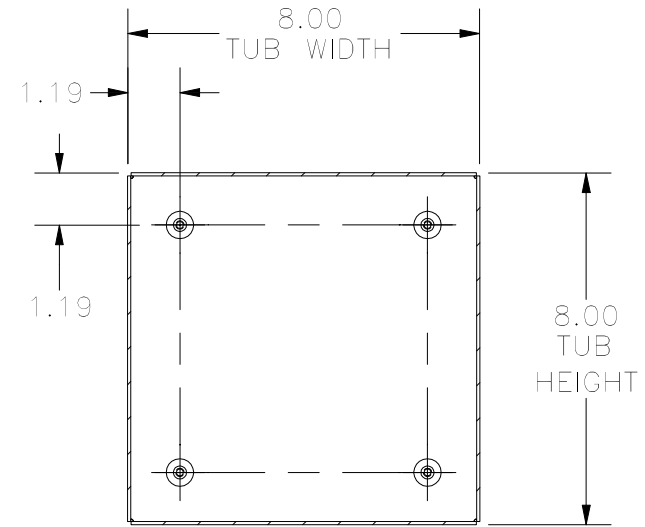

**SECTION A-A VIEW
(INSIDE BACK OF ENCL.)**

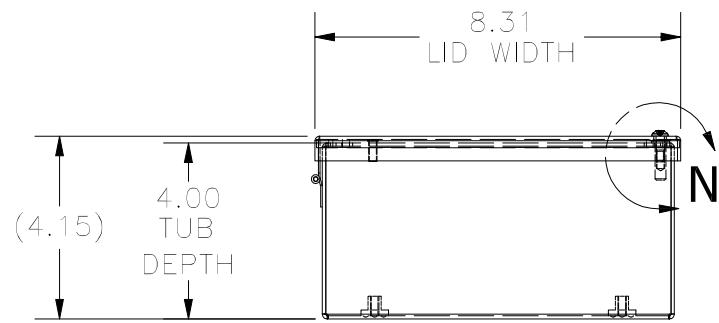

BOTTOM VIEW

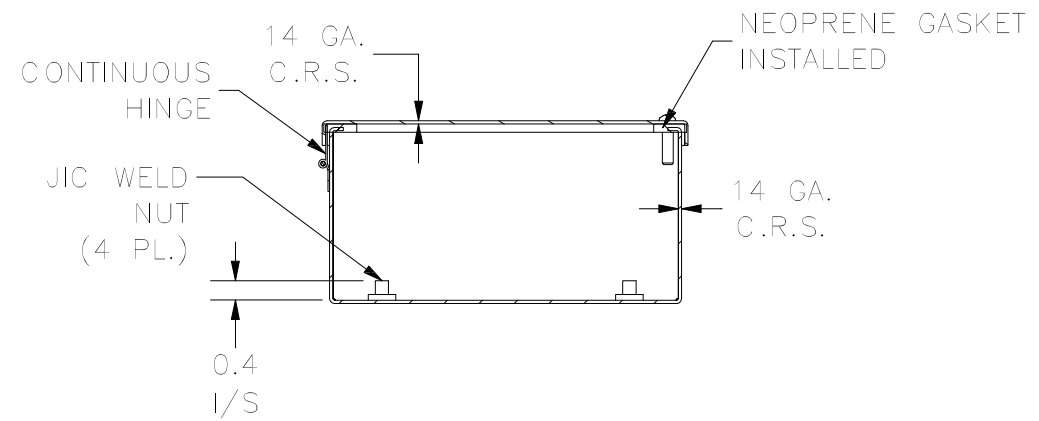

**SECTION B-B VIEW
(INSIDE TOP OF ENCL.)**

PART#: WA080804GIE
(DATA SUBJECT TO CHANGE WITHOUT NOTICE)

THIS DRAWING IS PROPERTY OF HUBBELL INC. WIEGMANN
ALL INFORMATION IS PROPRIETARY AND NOT TO BE DUPLICATED