

TOP VIEW

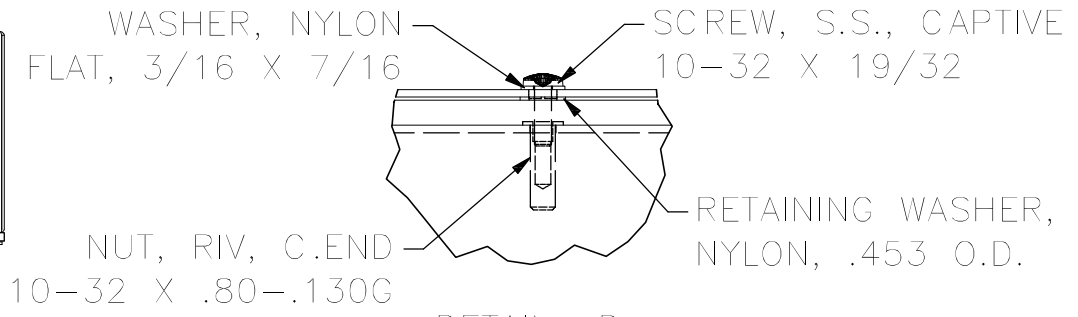

DETAIL D
(12 PL.)

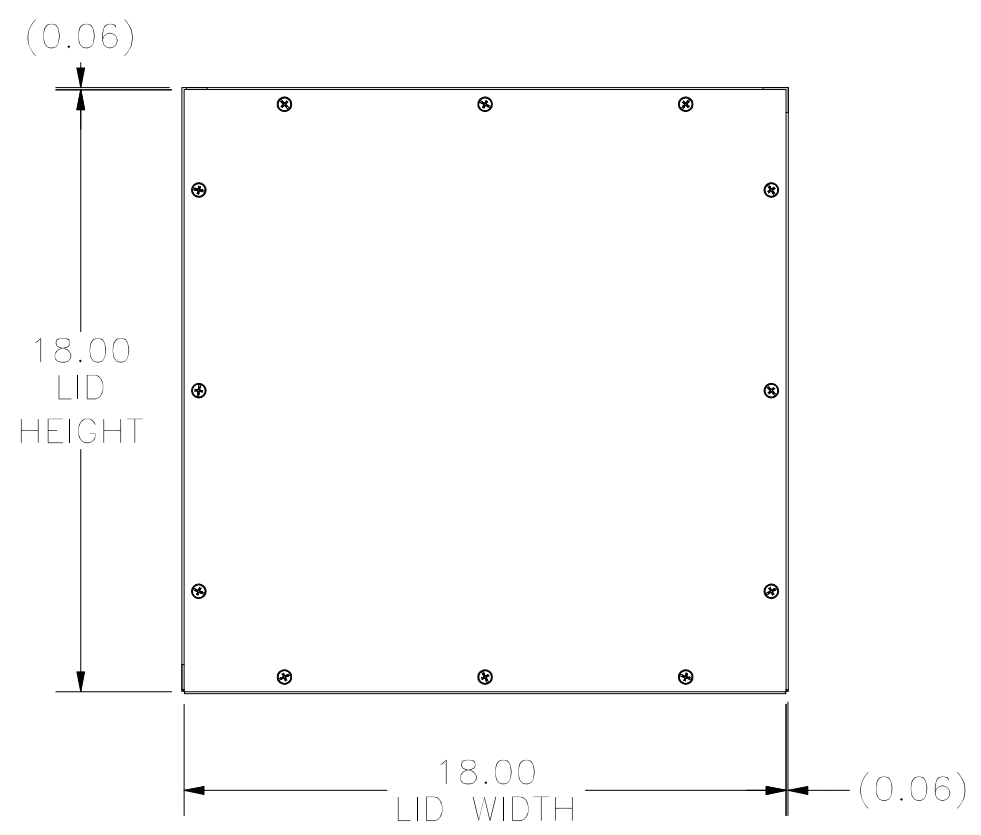

FRONT VIEW

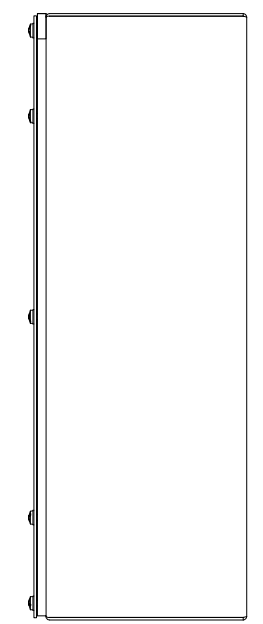

RIGHT SIDE VIEW

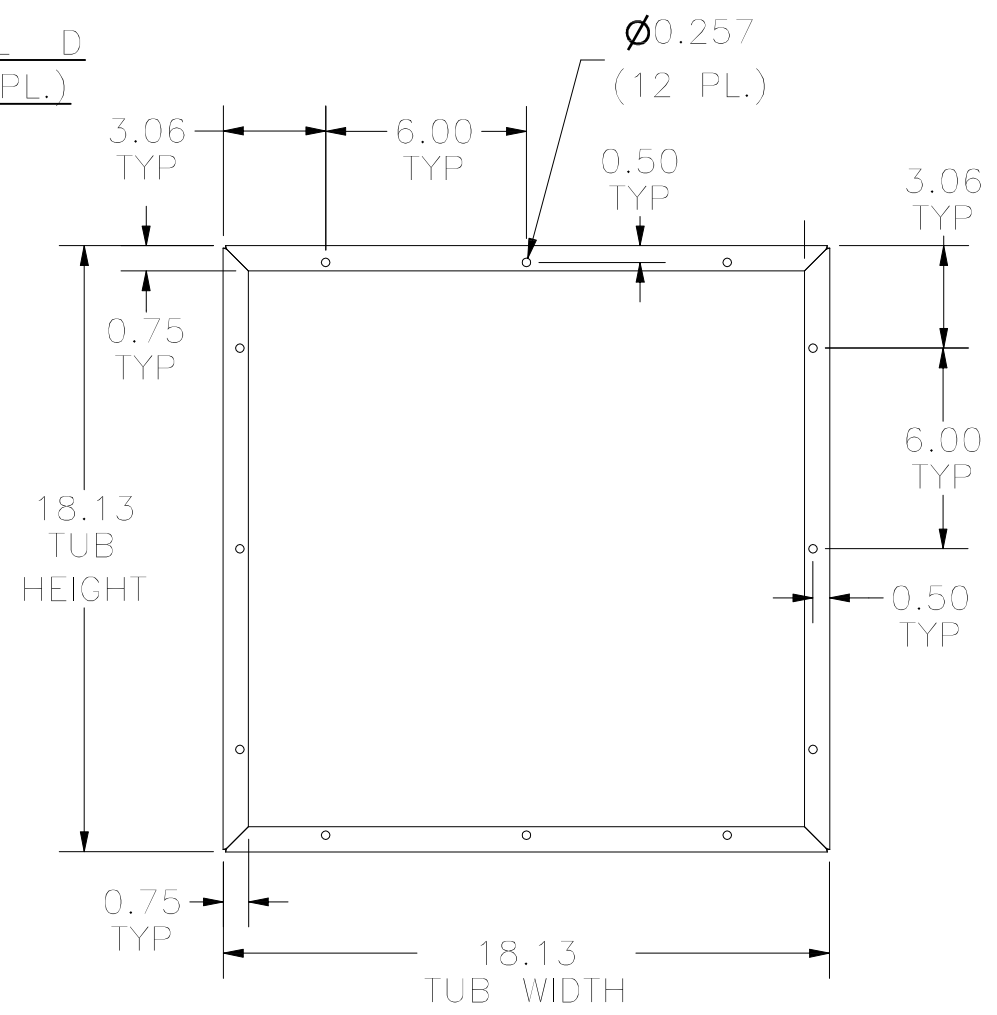

FRONT VIEW TUB

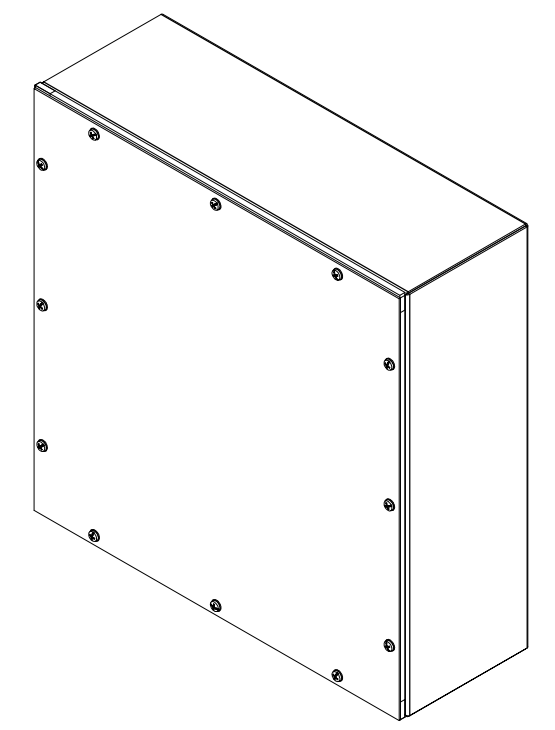

LEFT SIDE VIEW

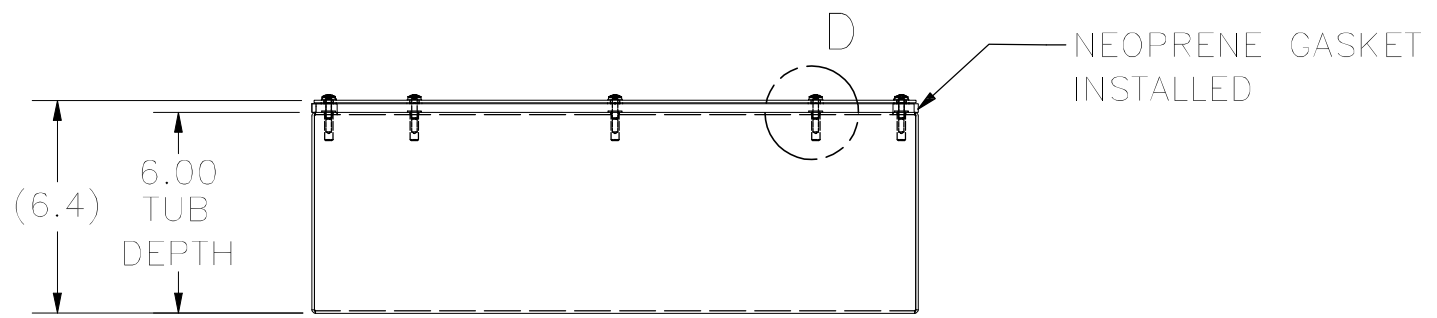

BOTTOM VIEW

PART#: WA181806GSC
(DATA SUBJECT TO CHANGE WITHOUT NOTICE)

THIS DRAWING IS PROPERTY OF HUBBELL INC. WIEGMANN
ALL INFORMATION IS PROPRIETARY AND NOT TO BE DUPLICATED