

**PART#: WA723024FS**  
**(DATA SUBJECT TO CHANGE WITHOUT NOTICE)**

THIS DRAWING IS PROPERTY OF HUBBELL INC. WIEGMANN ALL INFORMATION IS PROPRIETARY AND NOT TO BE DUPLICATED

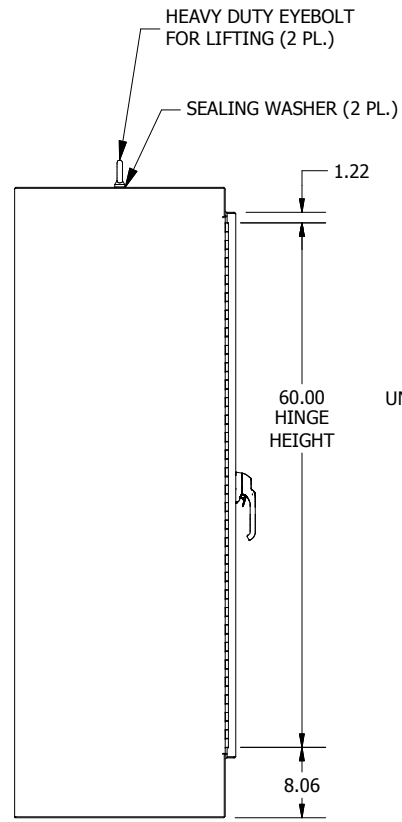

**LEFT SIDE VIEW**

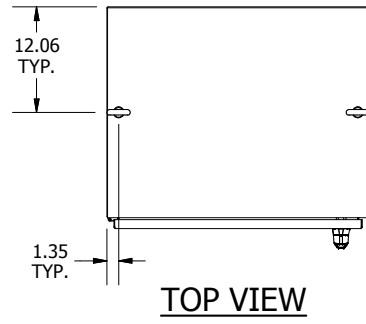
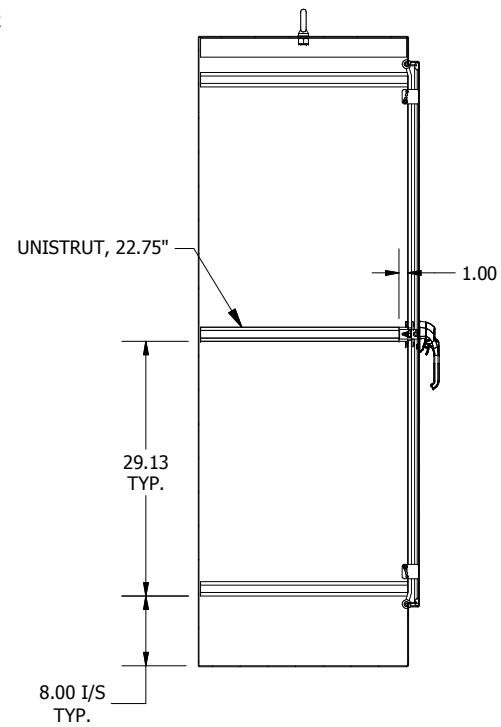

**SECTION A-A  
(INSIDE RIGHT OF ENCL.)**

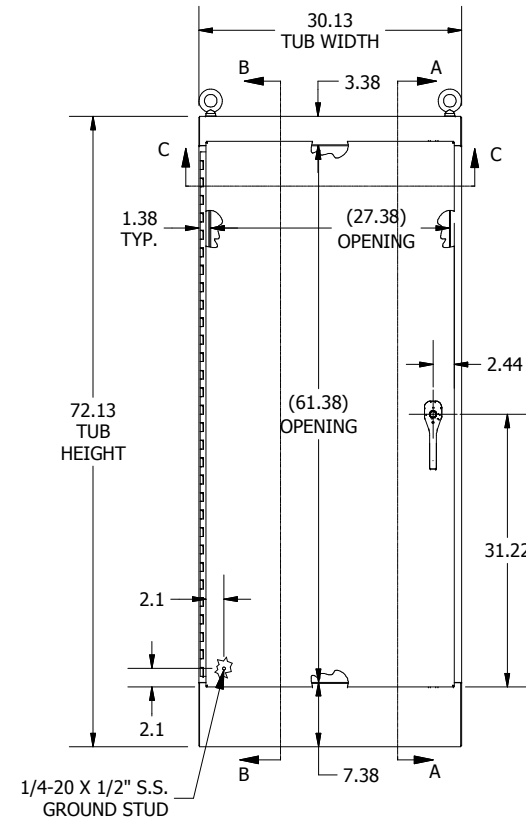

**FRONT VIEW**

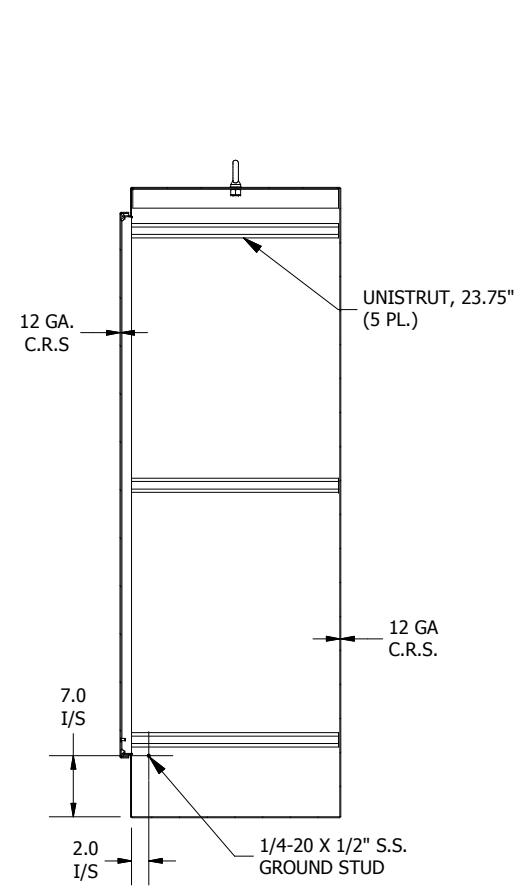

**SECTION B-B  
(INSIDE LEFT OF ENCL.)**

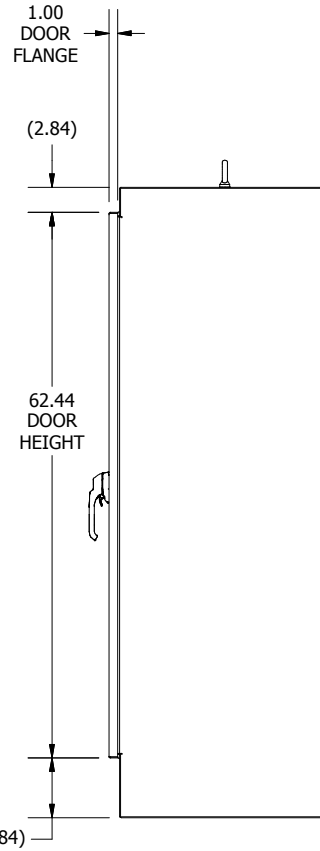

**RIGHT SIDE VIEW**

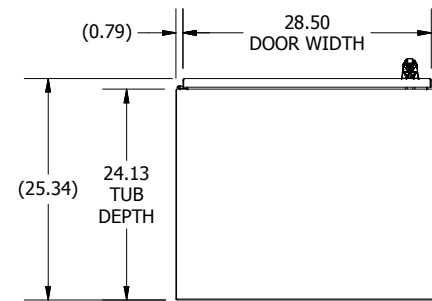

**BOTTOM VIEW**

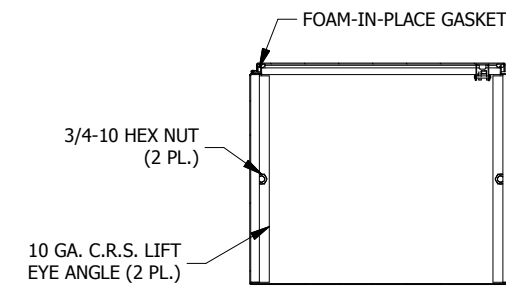

**SECTION C-C  
(INSIDE TOP OF ENCL.)**

